

CATALOGO OPERATIVO 2023





Produttori di apparecchi di illuminazione LED, forniamo soluzioni tecniche con alti standard qualitativi, grazie al continuo investimento in ricerca e sviluppo. Nati in Italia, con un'esperienza decennale, guardiamo al futuro con il continuo ampliamento della nostra linea di prodotti e l'espansione della rete commerciale, portando la qualità made in Italy in tutti i Paesi.

*Ledco Italia is a manufacturer of LED lighting fixtures. We provide technical solutions with high quality standards, with continuous investment in research and development. Born in Italy, with decades of experience, we look to the future with the continuous expansion of our product line and the expansion of the sales network, bringing made in Italy quality to all countries.*

## TESEO



Teseo  
pag. 8

## APPARECCHI MAGNETICI



Compatto  
pag. 12



Superfici Piane  
pag. 13



Incasso a  
Scomparsa  
pag. 14



Incasso a  
Scomparsa  
Regolabile  
pag. 15



Compatto a  
Sospensione  
pag. 16



a Sospensione  
pag. 17



Barre LED  
Magentiche  
pag. 19



Dark Light  
pag. 20



Dark Light  
Orientabile  
pag. 25



Tubo  
Magnetico  
pag. 27



Spot  
Magnetico  
pag. 29



Trasf. 48V  
pag. 34



Accessori  
per Spot  
pag. 36

## SPOT 220V



Spot  
220V  
pag. 38

## STRIP LED



SLP220  
pag. 48



COB - SLC50  
pag. 52



COB - SLC30ES  
pag. 53



SL500  
pag. 54



SL200 CRI97+  
pag. 56



SL200  
pag. 58



SL200ES  
pag. 59



SL180  
pag. 60



SL125  
pag. 61



SL120  
pag. 62



SL120ES  
pag. 63



SL60  
pag. 64



SL24  
pag. 65



Strip LED 20m  
pag. 66



Strip LED 30m  
pag. 70



Strip LED Food  
pag. 78



Dim to Warm  
pag. 80



Bianco Dinamico  
pag. 82



Wavy Strip  
pag. 84

## UVC - UVA



Strip UVC  
pag. 74



Strip UVA  
pag. 75



Barre UVC/UVA  
pag. 76

## WATERPROOF



SL200 IP67  
pag. 88



SL200ES IP67  
pag. 89



SL125 IP68  
pag. 90



SL120 30m IP68  
pag. 91



Strip RGB IP68  
pag. 92



Strip RGB.W IP68  
pag. 93



Strip Sauna  
pag. 94

## STRIP LED SPECIAL



Monocromatiche  
pag. 97



Strip RGB  
pag. 98



Strip RGB 240  
pag. 99



Strip RGB.W  
pag. 100



Strip RGB Dati  
pag. 101



Strip Runner  
pag. 102

## FLEX SERIES



Octopus  
pag. 106



Mini Flex  
pag. 111



Flex 916  
pag. 112

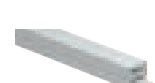

Flex 1616  
pag. 113



Flex 612  
pag. 114



Flex 1018  
pag. 115

## PROFILI IN ALLUMINIO



Compatibilità  
pag. 118



Superfici Piane  
pag. 122



Mini  
pag. 131



Calpestabili  
pag. 134



Incasso  
pag. 136



Scomparsa  
pag. 140



Angolari  
pag. 145



Sospensione  
pag. 148



Parete  
pag. 152

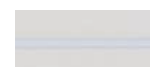

Line IN  
pag. 158

## BARRE LED



Barre LED  
pag. 164

## TRASFORMATORI



Compatti  
pag. 169



48V  
pag. 171



48V IP67  
pag. 172



Classe II  
pag. 175



Classe II Slim  
pag. 176



Tranf. Dali  
pag. 178



Tranf. 48V  
pag. 34

## CENTRALI MULTIZONA



CT580/BLE  
pag. 180



DM500/BLE  
pag. 181



CT360/B  
pag. 182



Wi-Fi  
pag. 183

## ACCESSORI



Controller  
pag. 187



DMX  
pag. 188



Dimmer  
pag. 189



Controller Parete  
pag. 190



CT800  
pag. 191



Amplificatore  
pag. 192



Kit Emergenza  
pag. 193



Connettori Rapidi  
pag. 194



Nastro Elettrificato  
pag. 195

# GRADO DI PROTEZIONE PROTECTION DEGREE

# IP



Prima Cifra - *First numeral*

Seconda Cifra - *Second numeral*

Prima Cifra - <i>First numeral</i>		Seconda Cifra - <i>Second numeral</i>	
Protezione contro la penetrazione di corpi solidi <i>Protection against penetration of solid object</i>		Protezione contro la penetrazione di corpi liquidi <i>Protection against penetration of water</i>	
<b>0</b>	Non protetto <i>Not Protected</i>	<b>0</b>	Non protetto <i>Not Protected</i>
<b>1</b>	Protetto contro corpi solidi sup. a 50 mm <i>Protected against solid object greater than 50 mm</i>	<b>1</b>	Protetto contro la caduta verticale di gocce d'acqua <i>Protected against dripping water</i>
<b>2</b>	Protetto contro corpi solidi sup. a 12 mm <i>Protected against solid object greater than 12 mm</i>	<b>2</b>	Protetto contro la caduta di gocce d'acqua con involucro inclinato di max 15° <i>Protected against dripping water when tilted up to 15°</i>
<b>3</b>	A prova di penetrazione di sonda con Ø 2,5 mm <i>Protected against solid object with Ø 2,5 mm</i>	<b>3</b>	Protetto contro la pioggia <i>Protected against spraying water</i>
<b>4</b>	A prova di penetrazione di sonda con Ø 1 mm <i>Protected against solid object with Ø 1 mm</i>	<b>4</b>	Protetto contro spruzzi d'acqua <i>Protected against water splashing</i>
<b>5</b>	Protetto contro la polvere <i>Dust-Protected</i>	<b>5</b>	Protetto contro i getti d'acqua <i>Protected against water jets</i>
<b>6</b>	Stagno alla polvere <i>Dust-tight</i>	<b>6</b>	Protetto contro le ondate <i>Protected against heavy seas</i>
		<b>7</b>	Stagno all'immersione <i>Protected against the effects of immersion</i>
		<b>8</b>	Stagno alla sommersione <i>Protected against submersion</i>

## RIVESTIMENTO NANOPARTICELLE NANOPARTICLES COATING

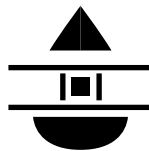

L'utilizzo del rivestimento in nano particelle (conformal coating) non altera l'aspetto della strip, garantendo protezione all'acqua (IP54) e una migliore dissipazione termica.

*The conformal coating covering doesn't change the external aspect of the strip, it guarantees a waterproof (IP54) and a better heat dissipation.*



# TESLO

Linea di luce tesa tra due pareti per caratterizzare i tuoi spazi in totale libertà.  
Line of light stretched between two walls to characterize your spaces in total freedom.



# TESEO - Illuminazione Tesa

## TESEO - Tense Lighting



- Attacco orientabile in verticale e orizzontale
- Lunghezza bandella 10 metri (sezionabile dal cliente)
- Bandella in acciaio AISI304 rivestita in PVC
- Due colorazioni disponibili: Nero o Bianco
- Strip LED ordinabile separatamente
- Cover bianca per installazione di luce diretta

- Connection can be oriented vertically and horizontally
- Strip length 10 meters (can be sectioned by the customer)
- PVC coated AISI304 steel strip
- Two colors available: Black or White
- Led strip can be ordered separately
- White cover for direct light installation

### TS10/NE - € 420

Teseo - Illuminazione lineare 10 metri nero  
Teseo - Linear lighting 10 meters black

### TS10/BI - € 420

Teseo - Illuminazione lineare 10 metri bianco  
Teseo - Linear lighting 10 meters white

 Dissipazione fino a 28w/mt  
Power dissipation up to 28w/mt

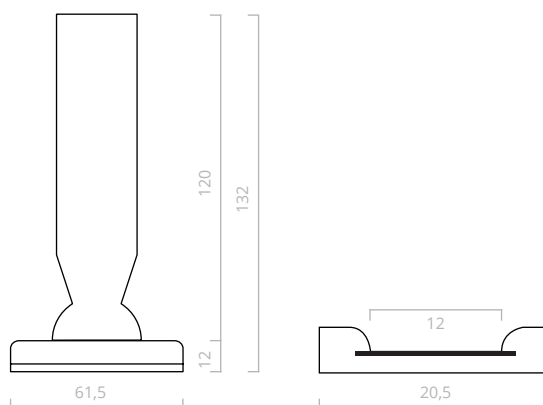

## ACCESSORI - ACCESSORIES



### TSG/NE - € 330

Giunti a parete - 2 pezzi - Nero  
Wall joints - 2 pieces - Black

### TSG/BI - € 330

Giunti a parete - 2 pezzi - Bianco  
Wall joints - 2 pieces - White



### TS10/C/BI - € 60

Cover bianca - 10 metri  
White cover - 10 meters



### NE205 - € 11/mt

Nastro adesivo elettrico - verniciabile (dettagli pag. 195)  
Due piste da 0,5mm<sup>2</sup> - Larghezza 15mm - Spessore 0,25mm.  
Electrical adhesive tape, paintable (for details see page 195)  
Two 0,5mm<sup>2</sup> - Width 15mm - Thickness 0,25mm.



# line48

La soluzione definitiva per l'illuminazione del retail o ambienti domestici, il punto di incontro tra la versatilità di un binario elettrificato e la facilità d'uso di un sistema magnetico a 48V.

The ultimate solution for retail lighting or home environments, the meeting point between the versatility of an electrified track and the ease of use of a 48V magnetic system.



# BINARIO 48V - Compatto Superfici Piane

## 48V TRACK - Compact Flat Surfaces

linea48



- Profilo estruso in alluminio puro al 99%
- Verniciato a polveri epossidiche
- Elettrificato con 4 conduttori in rame da 2mm<sup>2</sup> - max 15A
- Versione per montaggio a soffitto
- Il binario può essere tagliato sul posto di lavoro nelle dimensioni desiderate

**MG140/NE/1MT** - € 85  
Binario Magnetico 1 metro nero  
*Magnetic track 1 meter black*

**MG140/BI/1MT** - € 85  
Binario Magnetico 1 metro bianco  
*Magnetic track 1 meter white*

**MG140/NE** - € 150  
Binario Magnetico 2 metri nero  
*Magnetic track 2 meter black*

**MG140/BI** - € 150  
Binario Magnetico 2 metri bianco  
*Magnetic track 2 meter white*

**MG140/NE/3MT** - € 250  
Binario Magnetico 3 metri nero  
*Magnetic track 3 meter black*

**MG140/BI/3MT** - € 250  
Binario Magnetico 3 metri bianco  
*Magnetic track 3 meter white*

\*Disponibili da Aprile 2023  
\*Available from April 2023

### SCHEMA DI COLLEGAMENTO CONNECTION DIAGRAM

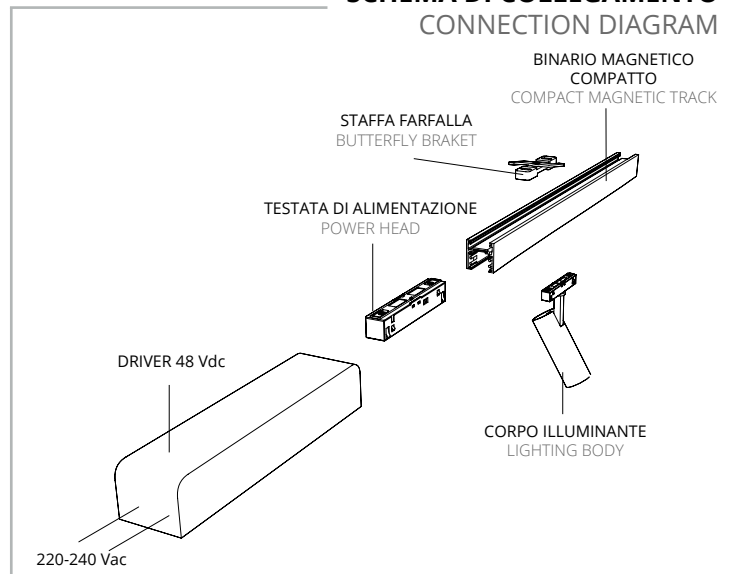

### ACCESSORI - ACCESSORIES

**EN140/NE** - € 5  
Tappo di chiusura nero per binario magnetico  
*Black closing cap for magnetic track*

**EN140/BI** - € 5  
Tappo di chiusura bianco per binario magnetico  
*White closing cap for magnetic track*

**MGAL/NE** - € 22,50  
Modulo alimentazione 4p magnetico nero  
*Black magnetic 4p power supply module*

**MGAL/BI** - € 22,50  
Modulo alimentazione 4p magnetico bianco  
*White magnetic 4p power supply module*

**MGCOF540/NE** - € 30,50  
Giunzione flessibile nero per binario magnetico  
*Black flexible joint for magnetic track*

**MGCOF540/BI** - € 30,50  
Giunzione flessibile bianco per binario magnetico  
*White flexible joint for magnetic track*

Dimensione totale: 350mm  
*Total Dimension: 350mm*

**MGEN040/NE** - € 9,50  
Staffa per installazione a superficie nera  
*Black bracket for surface installation*

**MGEN040/BI** - € 9,50  
Staffa per installazione a superficie bianca  
*White bracket for surface installation*  
Per installare un binario da 2mt occorrono 3 staffe  
*3 bracket are required to install a 2mt track*

**CO540X/NE** - € 14  
Giunzione lineare meccanica nera  
*Black mechanical linear joint*

**CO540X/BI** - € 14  
Giunzione lineare meccanica bianca  
*White mechanical linear joint*

**MGALC/NE** - € 22,50  
Giunzione lineare elettrica nera  
*Black electrical linear junction*

**MGALC/BI** - € 22,50  
Giunzione lineare elettrica bianca  
*White electrical linear junction*

**MGCO540/NE1** - € 22,50  
Giunzione angolare elettrica 90° nero  
*Black 90° electrical corner joint*

**MGCO540/BI1** - Bianco | White

**MGCO140/NE2** - € 47,50  
Giunzione angolare meccanica a 90° nera  
*90° black mechanical corner joint*

**MGCO140/BI2** - € 47,50  
Giunzione angolare meccanica a 90° bianca  
*90° white mechanical corner joint*

\* **TR48100/MG/NE** - € 150  
Alimentatore a scomparsa 100W nero  
*100W black retractable power supply*

\* **TR48100/MG/BI** - € 150  
Alimentatore a scomparsa 100W bianco  
*100W white retractable power supply*

\* **TR48200/MG/NE** - € 180  
Alimentatore a scomparsa 200W nero  
*200W black retractable power supply*

\* **TR48200/MG/BI** - € 180  
Alimentatore a scomparsa 200W bianco  
*200W white retractable power supply*

\* Nel binario magnetico compatto il trasformatore TR48100/MG/NE e TR48100/MG/BI sporge di 26mm dal binario, il TR48200/MG/NE e TR48200/MG/BI sporge di 28mm.

\* In the compact magnetic track, the TR48100/MG transformer will come out 26mm from the track, instead TR48200/MG transformer 28mm.

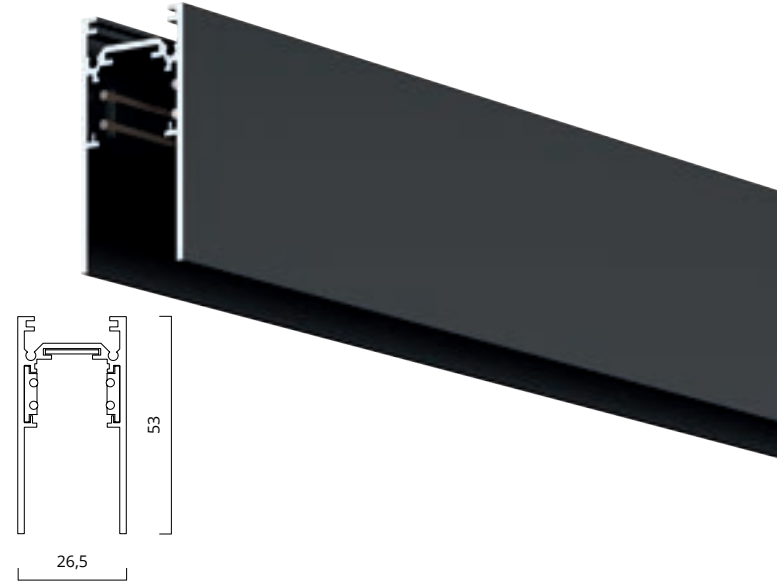
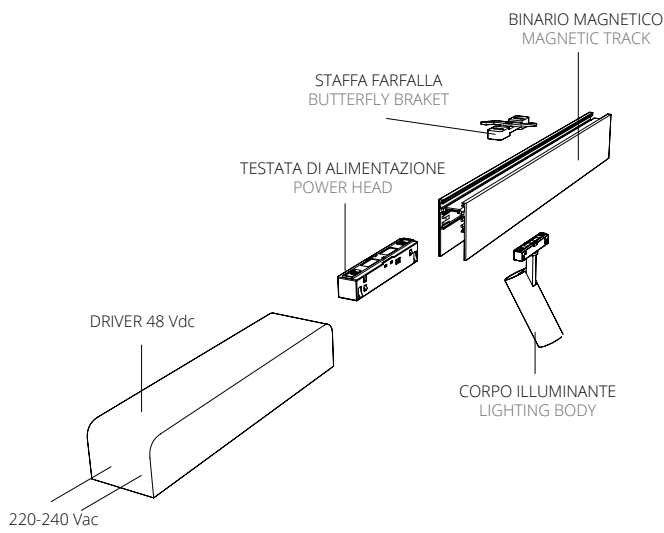
SCHEMA DI COLLEGAMENTO  
CONNECTION DIAGRAM

- Profilo estruso in alluminio puro al 99%
- Verniciato a polveri epossidiche
- Elettrificato con 4 conduttori in rame da 2mm<sup>2</sup> - max 15A
- Versione per montaggio a soffitto
- Il binario può essere tagliato sul posto di lavoro nelle dimensioni desiderate

- 99% pure aluminum extruded profile
- Painted with epoxy powders
- Electrified with 4 conductor, made of 2mm<sup>2</sup> copper max 15A
- Wall/Ceiling mounting version
- The track can be cut to length at side

**MG540/NE/1MT - € 105**  
Binario Magnetico 1 metro nero  
Magnetic track 1 meter black

**MG540/NE - € 190**  
Binario Magnetico 2 metri nero  
Magnetic track 2 meter black

**MG540/NE/3MT - € 300**  
Binario Magnetico 3 metri nero  
Magnetic track 3 meter black

**MG540/BI/1MT - € 105**  
Binario Magnetico 1 metro bianco  
Magnetic track 1 meter white

**MG540/BI - € 190**  
Binario Magnetico 2 metri bianco  
Magnetic track 2 meter white

**MG540/BI/3MT - € 300**  
Binario Magnetico 3 metri bianco  
Magnetic track 3 meter white

\*Disponibili da Aprile 2023  
\*Available from April 2023

## ACCESSORI - ACCESSORIES

**EN540/NE - € 5,50**  
Tappo di chiusura nero per binario magnetico  
Black closing cap for magnetic track

**EN540/BI - € 5,50**  
Tappo di chiusura bianco per binario magnetico  
White closing cap for magnetic track

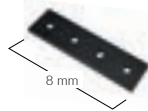

**CO540X/NE - € 14**  
Giunzione lineare meccanica nera  
Black mechanical linear joint

**CO540X/BI - € 14**  
Giunzione lineare meccanica bianca  
White mechanical linear joint



**TR48100/MG/NE - € 150**  
Alimentatore a scomparsa 100W nero  
100W black retractable power supply

**TR48100/MG/BI - € 150**  
Alimentatore a scomparsa 100W bianco  
100W white retractable power supply

**TR48200/MG/NE - € 180**  
Alimentatore a scomparsa 200W nero  
200W black retractable power supply

**TR48200/MG/BI - € 180**  
Alimentatore a scomparsa 200W bianco  
200W white retractable power supply



**MGAL/NE - € 22,50**  
Modulo alimentazione 4p magnetico nero  
Black magnetic 4p power supply module

**MGAL/BI - € 22,50**  
Modulo alimentazione 4p magnetico bianco  
White magnetic 4p power supply module



**MGALC/NE - € 22,50**  
Giunzione lineare elettrica nera  
Black electrical linear junction

**MGALC/BI - € 22,50**  
Giunzione lineare elettrica bianca  
White electrical linear junction



**MGCOF540/NE - € 30,50**  
Giunzione flessibile nero per binario magnetico  
Black flexible joint for magnetic track

**MGCOF540/BI - € 30,50**  
Giunzione flessibile bianco per binario magnetico  
White flexible joint for magnetic track

Dimensione totale: 350mm  
Total Dimension: 350mm



**MGCO540/NE1 - € 22,50**  
Giunzione angolare elettrica 90° nero  
Black 90° electrical corner joint

**MGCO540/BI1 - Bianco | White**



**MGEN040/NE - € 9,50**  
Staffa per installazione a superficie nera  
Black bracket for surface installation

**MGEN040/BI - € 9,50**  
Staffa per installazione a superficie bianca  
White bracket for surface installation

Per installare un binario da 2mt occorrono 3 staffe  
3 bracket are required to install a 2mt track

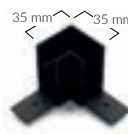

**MGCO540/NE2 - € 55,50**  
Giunzione angolare meccanica a 90° nera  
90° black mechanical corner joint

**MGCO540/BI2 - € 55,50**  
Giunzione angolare meccanica a 90° bianca  
90° white mechanical corner joint

# BINARIO 48V - Incasso a Scomparsa

## 48V TRACK - Trimless Recessed

line48

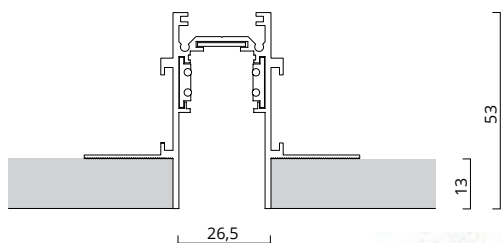

### SCHEMA DI COLLEGAMENTO CONNECTION DIAGRAM

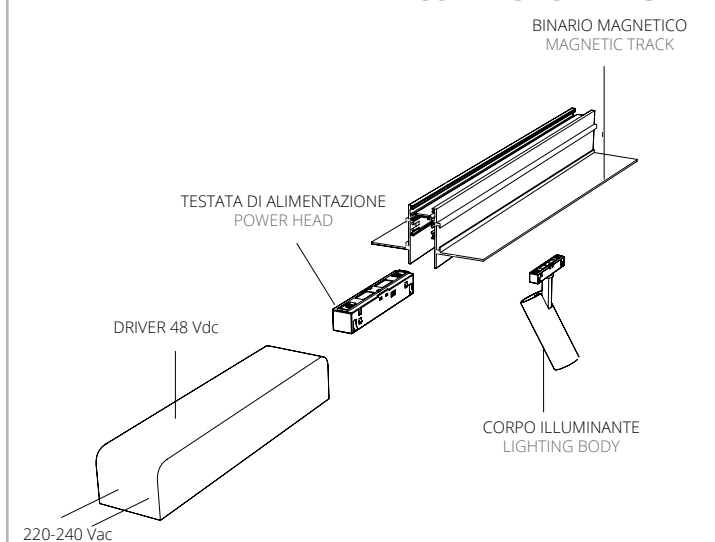

- Profilo estruso in alluminio puro al 99%
- Verniciato a polveri epossidiche
- Elettrificato con 4 conduttori in rame da 2mm<sup>2</sup> - max 15A
- Versione per montaggio ad incasso a scomparsa
- Il binario può essere tagliato sul posto di lavoro nelle dimensioni desiderate

- 99% pure aluminum extruded profile
- Painted with epoxy powders
- Electrified with 4 conductor, made of 2mm<sup>2</sup> copper max 15A
- Trimless recessed mounting version
- The track can be cut to length at side

**MG240/NE/1MT** - € 105  
Binario Magnetico 1 metro nero  
*Magnetic track 1 meter black*

**MG240/NE** - € 200  
Binario Magnetico 2 metri nero  
*Magnetic track 2 meter black*

**MG240/NE/3MT** - € 320  
Binario Magnetico 3 metri nero  
*Magnetic track 3 meter black*

**MG240/BI/1MT** - € 105  
Binario Magnetico 1 metro bianco  
*Magnetic track 1 meter white*

**MG240/BI** - € 200  
Binario Magnetico 2 metri bianco  
*Magnetic track 2 meter white*

**MG240/BI/3MT** - € 320  
Binario Magnetico 3 metri bianco  
*Magnetic track 3 meter white*

\*Disponibili da Aprile 2023  
\*Available from April 2023

### ACCESSORI - ACCESSORIES

**EN540/NE** - € 5,50  
Tappo di chiusura nero per binario magnetico  
*Black closing cap for magnetic track*

**EN540/BI** - € 5,50  
Tappo di chiusura bianco per binario magnetico  
*White closing cap for magnetic track*

**CO540X/NE** - € 14  
Giunzione lineare meccanica nera  
*Black mechanical linear joint*

**CO540X/BI** - € 14  
Giunzione lineare meccanica bianca  
*White mechanical linear joint*

**MGAL/NE** - € 22,50  
Modulo alimentazione 4p magnetico nero  
*Black magnetic 4p power supply module*

**MGAL/BI** - € 22,50  
Modulo alimentazione 4p magnetico bianco  
*White magnetic 4p power supply module*

**MGALC/NE** - € 22,50  
Giunzione lineare elettrica nera  
*Black electrical linear junction*

**MGALC/BI** - € 22,50  
Giunzione lineare elettrica bianca  
*White electrical linear junction*

**MGCOF540/NE** - € 30,50  
Giunzione flessibile nero per binario magnetico  
*Black flexible joint for magnetic track*

**MGCOF540/BI** - € 30,50  
Giunzione flessibile bianco per binario magnetico  
*White flexible joint for magnetic track*  
Dimensione totale: 350mm  
*Total Dimension: 350mm*

**MGCO240/NE2** - € 58,50  
Giunzione angolare meccanica a 90° nera  
*90° black mechanical corner joint*

**MGCO240/BI2** - € 58,50  
Giunzione angolare meccanica a 90° bianca  
*90° white mechanical corner joint*

**PR940/NE** - € 12,50  
Cover da cantiere nera 2 metri  
*Black cover 2 meters*

**PR940/NE/1** - € 6,50  
Cover da cantiere nera 1 metro  
*Black cover 1 meter*



**TR48100/MG/NE** - € 150  
Alimentatore a scomparsa 100W nero  
*100W black retractable power supply*

**TR48100/MG/BI** - € 150  
Alimentatore a scomparsa 100W bianco  
*100W white retractable power supply*

**TR48200/MG/NE** - € 180  
Alimentatore a scomparsa 200W nero  
*200W black retractable power supply*

**TR48200/MG/BI** - € 180  
Alimentatore a scomparsa 200W bianco  
*200W white retractable power supply*

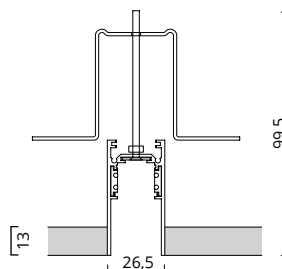
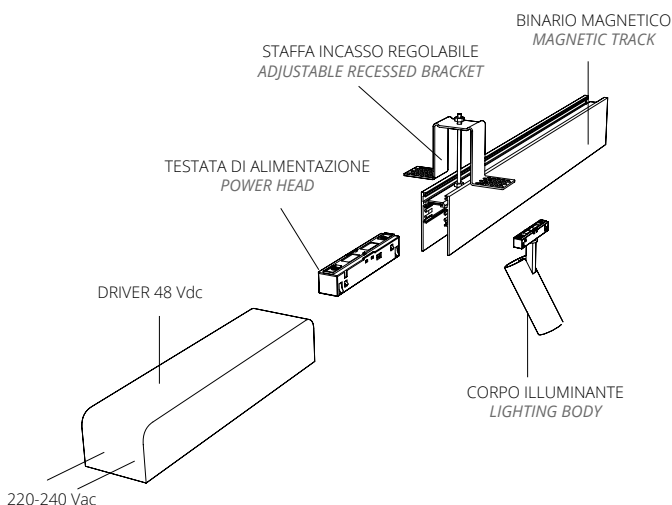
SCHEMA DI COLLEGAMENTO  
CONNECTION DIAGRAM

Staffa regolabile per controsoffitti di qualsiasi spessore  
Adjustable bracket for false ceilings on any thickness

- Profilo estruso in alluminio puro al 99%
- Verniciato a polveri epossidiche
- Elettrificato con 4 conduttori in rame da 2mm<sup>2</sup> - max 15A
- Versione per montaggio ad incasso a scomparsa
- Il binario può essere tagliato sul posto di lavoro nelle dimensioni desiderate

- 99% pure aluminum extruded profile
- Painted with epoxy powders
- Electrified with 4 conductor, made of 2mm<sup>2</sup> copper max 15A
- Trimless recessed mounting version
- The track can be cut to length at side

**MG540/NE/1MT** - € 105

Binario Magnetico 1 metro nero  
Magnetic track 1 meter black

**MG540/BI/1MT** - € 105

Binario Magnetico 1 metro bianco  
Magnetic track 1 meter white

**MG540/NE** - € 190

Binario Magnetico 2 metri nero  
Magnetic track 2 meter black

**MG540/BI** - € 190

Binario Magnetico 2 metri bianco  
Magnetic track 2 meter white

**MG540/NE/3MT** - € 300

Binario Magnetico 3 metri nero  
Magnetic track 3 meter black

**MG540/BI/3MT** - € 300

Binario Magnetico 3 metri bianco  
Magnetic track 3 meter white

\*Disponibili da Aprile 2023  
\*Available from April 2023

## ACCESSORI - ACCESSORIES

**EN540/NE** - € 5,50

Tappo di chiusura nero per binario magnetico  
Black closing cap for magnetic track

**EN540/BI** - € 5,50

Tappo di chiusura bianco per binario magnetico  
White closing cap for magnetic track

**CO540X/NE** - € 14

Giunzione lineare meccanica nera  
Black mechanical linear joint

**CO540X/BI** - € 14

Giunzione lineare meccanica bianca  
White mechanical linear joint

**TR48100/MG/NE** - € 150

Alimentatore a scomparsa 100W nero  
100W black retractable power supply

**TR48100/MG/BI** - € 150

Alimentatore a scomparsa 100W bianco  
100W white retractable power supply

**TR48200/MG/NE** - € 180

Alimentatore a scomparsa 200W nero  
200W black retractable power supply

**TR48200/MG/BI** - € 180

Alimentatore a scomparsa 200W bianco  
200W white retractable power supply

**MGAL/NE** - € 22,50

Modulo alimentazione 4p magnetico nero  
Black magnetic 4p power supply module

**MGAL/BI** - € 22,50

Modulo alimentazione 4p magnetico bianco  
White magnetic 4p power supply module

**MGALC/NE** - € 22,50

Giunzione lineare elettrica nera  
Black electrical linear junction

**MGALC/BI** - € 22,50

Giunzione lineare elettrica bianca  
White electrical linear junction

**MGCOF540/NE** - € 30,50

Giunzione flessibile nero per binario magnetico  
Black flexible joint for magnetic track

**MGCOF540/BI** - € 30,50

Giunzione flessibile bianco per binario magnetico  
White flexible joint for magnetic track

Dimensione totale: 350mm  
Total Dimension: 350mm

**MGCO540/NE1** - € 22,50

Giunzione angolare elettrica 90° nero  
Black 90° electrical corner joint

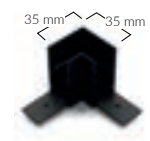
**MGCO540/BI1** - Bianco | White**MGCO540/NE2** - € 55,50

Giunzione angolare meccanica a 90° nera  
90° black mechanical corner joint

**MGCO540/BI2** - € 55,50

Giunzione angolare meccanica a 90° bianca  
90° white mechanical corner joint

**ENX540** - € 11

Staffa per installazione ad incasso  
Bracket for recessed installation

Per installare un binario da 2mt occorrono 3 staffe  
3 bracket are required to install a 2mt track

**PR940/NE** - € 12,50

Cover da cantiere nera 2 metri  
Black cover 2 meters

**PR940/NE/1** - € 6,50

Cover da cantiere nera 1 metro  
Black cover 1 meter

# BINARIO 48V - Compatto a Sospensione

## 48V TRACK - Suspended compact

line48

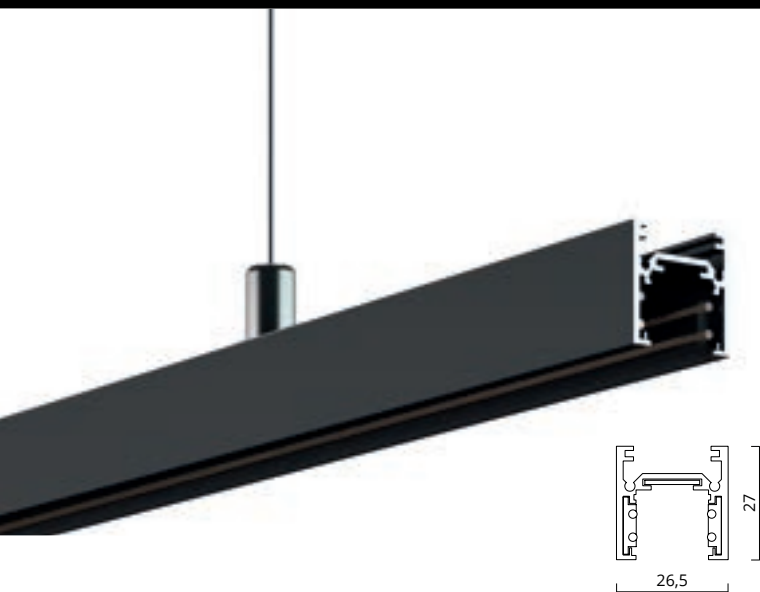

- Profilo estruso in alluminio puro al 99%
- Verniciato a polveri epossidiche
- Elettrificato con 4 conduttori in rame da 2mm<sup>2</sup> - max 15A
- Versione per montaggio a sospensione
- Il binario può essere tagliato sul posto di lavoro nelle dimensioni desiderate

**MG140/NE/1MT** - € 85  
Binario Magnetico 1 metro nero  
*Magnetic track 1 meter black*

**MG140/BI/1MT** - € 85  
Binario Magnetico 1 metro bianco  
*Magnetic track 1 meter white*

**MG140/NE** - € 150  
Binario Magnetico 2 metri nero  
*Magnetic track 2 meter black*

**MG140/BI** - € 150  
Binario Magnetico 2 metri bianco  
*Magnetic track 2 meter white*

**MG140/NE/3MT** - € 250  
Binario Magnetico 3 metri nero  
*Magnetic track 3 meter black*

**MG140/BI/3MT** - € 250  
Binario Magnetico 3 metri bianco  
*Magnetic track 3 meter white*

\*Disponibili da Aprile 2023  
\*Available from April 2023

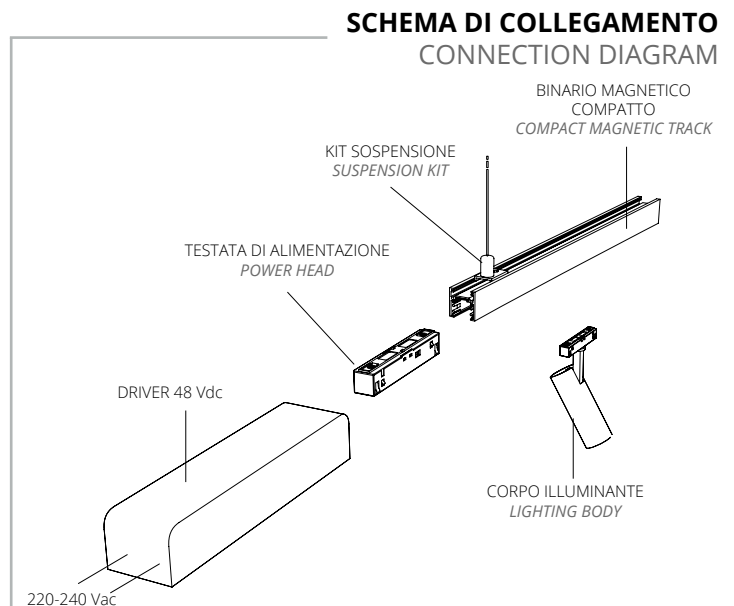

- 99% pure aluminum extruded profile
- Painted with epoxy powders
- Electrified with 4 conductor, made of 2mm<sup>2</sup> copper max 15A
- Suspended mounting version
- The track can be cut to length at side

## ACCESSORI - ACCESSORIES

**EN140/NE** - € 5  
Tappo di chiusura nero per binario magnetico  
*Black closing cap for magnetic track*

**EN140/BI** - € 5  
Tappo di chiusura bianco per binario magnetico  
*White closing cap for magnetic track*

**MGAL/NE** - € 22,50  
Modulo alimentazione 4p magnetico nero  
*Black magnetic 4p power supply module*

**MGAL/BI** - € 22,50  
Modulo alimentazione 4p magnetico bianco  
*White magnetic 4p power supply module*

**MGCOF540/NE** - € 30,50  
Giunzione flessibile nero per binario magnetico  
*Black flexible joint for magnetic track*

**MGCOF540/BI** - € 30,50  
Giunzione flessibile bianco per binario magnetico  
*White flexible joint for magnetic track*  
Dimensione totale: 350mm  
*Total Dimension: 350mm*

**MGCO140/NE2** - € 47,50  
Giunzione angolare meccanica a 90° nera  
*90° black mechanical corner joint*

**MGCO140/BI2** - € 47,50  
Giunzione angolare meccanica a 90° bianca  
*90° white mechanical corner joint*

**CO540X/NE** - € 14  
Giunzione lineare meccanica nera  
*Black mechanical linear joint*

**CO540X/BI** - € 14  
Giunzione lineare meccanica bianca  
*White mechanical linear joint*

**MGALC/NE** - € 22,50  
Giunzione lineare elettrica nera  
*Black electrical linear junction*

**MGALC/BI** - € 22,50  
Giunzione lineare elettrica bianca  
*White electrical linear junction*

**MGCO540/NE1** - € 22,50  
Giunzione angolare elettrica 90° nero  
*Black 90° electrical corner joint*

**MGCO540/BI1** - Bianco | White

**MGSN540/C/NE** - € 14,50  
Kit sospensione binario magnetico nero  
*Black suspension kit for magnetic track*

**MGSN540/C/BI** - € 14,50  
Kit sospensione binario magnetico bianco  
*White suspension kit for magnetic track*

\* **TR48100/MG/NE** - € 150  
Alimentatore a scomparsa 100W nero  
*100W black retractable power supply*

\* **TR48100/MG/BI** - € 150  
Alimentatore a scomparsa 100W bianco  
*100W white retractable power supply*

\* **TR48200/MG/NE** - € 180  
Alimentatore a scomparsa 200W nero  
*200W black retractable power supply*

\* **TR48200/MG/BI** - € 180  
Alimentatore a scomparsa 200W bianco  
*200W white retractable power supply*

\* Nel binario magnetico compatto il trasformatore TR48100/MG/NE e TR48100/MG/BI sporge di 26mm dal binario, il TR48200/MG/NE e TR48200/MG/BI sporge di 28mm.

\* In the compact magnetic track, the TR48100/MG transformer will come out 26mm from the track, instead TR48200/MG transformer 28mm.

Per la sospensione di un binario da 2mt occorrono 3 Kit  
3 kits are required to suspend a 2mt track

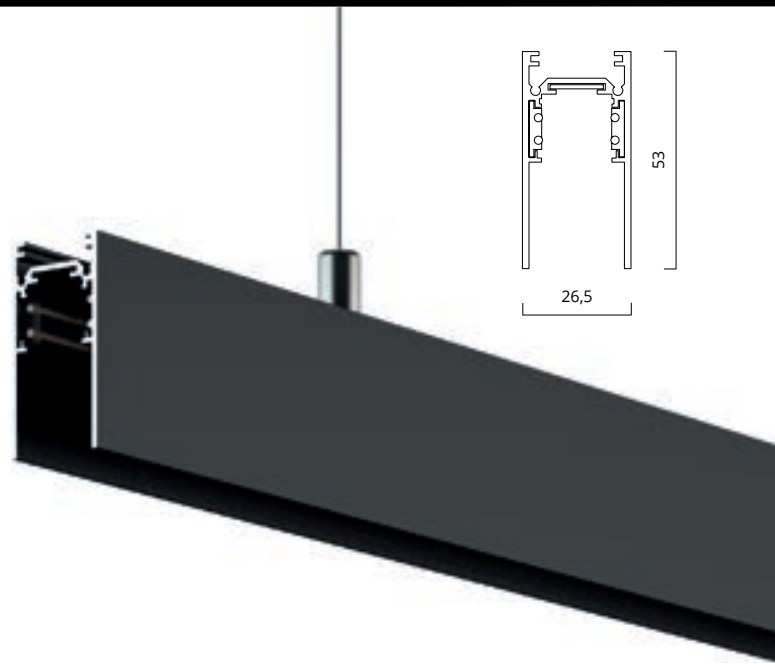
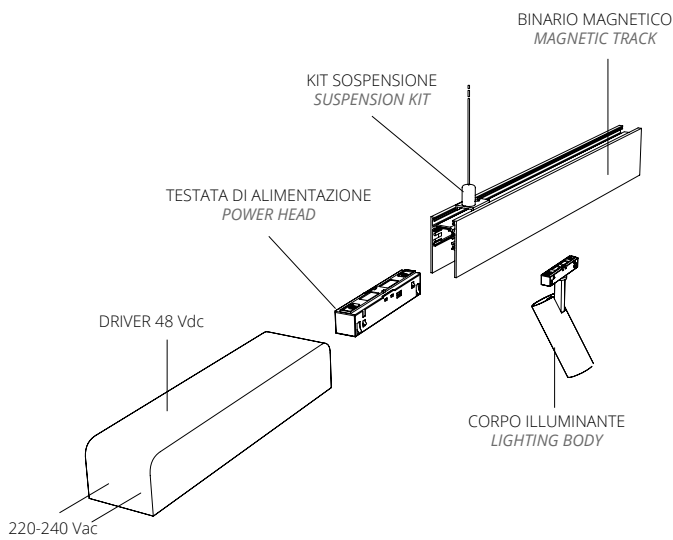

SCHEMA DI COLLEGAMENTO  
CONNECTION DIAGRAM

- Profilo estruso in alluminio puro al 99%
- Verniciato a polveri epossidiche
- Elettrificato con 4 conduttori in rame da 2mm<sup>2</sup> - max 15A
- Versione per montaggio a sospensione
- Il binario può essere tagliato sul posto di lavoro nelle dimensioni desiderate

- 99% pure aluminum extruded profile
- Painted with epoxy powders
- Electrified with 4 conductor, made of 2mm<sup>2</sup> copper max 15A
- Suspended mounting version
- The track can be cut to length at side

**MG540/NE/1MT** - € 105  
Binario Magnetico 1 metro nero  
*Magnetic track 1 meter black*

**MG540/NE** - € 190  
Binario Magnetico 2 metri nero  
*Magnetic track 2 meter black*

**MG540/NE/3MT** - € 300  
Binario Magnetico 3 metri nero  
*Magnetic track 3 meter black*

**MG540/BI/1MT** - € 105  
Binario Magnetico 1 metro bianco  
*Magnetic track 1 meter white*

**MG540/BI** - € 190  
Binario Magnetico 2 metri bianco  
*Magnetic track 2 meter white*

**MG540/BI/3MT** - € 300  
Binario Magnetico 3 metri bianco  
*Magnetic track 3 meter white*

\*Disponibili da Aprile 2023  
\*Available from April 2023

## ACCESSORI - ACCESSORIES

**EN540/NE** - € 5,50  
Tappo di chiusura nero per binario magnetico  
*Black closing cap for magnetic track*

**EN540/BI** - € 5,50  
Tappo di chiusura bianco per binario magnetico  
*White closing cap for magnetic track*

**CO540X/NE** - € 14  
Giunzione lineare meccanica nera  
*Black mechanical linear joint*

**CO540X/BI** - € 14  
Giunzione lineare meccanica bianca  
*White mechanical linear joint*

**MGAL/NE** - € 22,50  
Modulo alimentazione 4p magnetico nero  
*Black magnetic 4p power supply module*

**MGAL/BI** - € 22,50  
Modulo alimentazione 4p magnetico bianco  
*White magnetic 4p power supply module*

**MGALC/NE** - € 22,50  
Giunzione lineare elettrica nera  
*Black electrical linear junction*

**MGALC/BI** - € 22,50  
Giunzione lineare elettrica bianca  
*White electrical linear junction*

**MGCOF540/NE** - € 30,50  
Giunzione flessibile nero per binario magnetico  
*Black flexible joint for magnetic track*

**MGCOF540/BI** - € 30,50  
Giunzione flessibile bianco per binario magnetico  
*White flexible joint for magnetic track*  
Dimensione totale: 350mm  
*Total Dimension: 350mm*

**MGCO540/NE1** - € 22,50  
Giunzione angolare elettrica 90° nero  
*Black 90° electrical corner joint*

**MGCO540/BI1** - Bianco | White

**MGCO540/NE2** - € 55,50  
Giunzione angolare meccanica a 90° nera  
*90° black mechanical corner joint*

**MGCO540/BI2** - € 55,50  
Giunzione angolare meccanica a 90° bianca  
*90° white mechanical corner joint*

**MGSN540/C/NE** - € 14,50  
Kit sospensione binario magnetico nero  
*Black suspension kit for magnetic track*

**MGSN540/C/BI** - € 14,50  
Kit sospensione binario magnetico bianco  
*White suspension kit for magnetic track*

Per la sospensione di un binario da 2mt occorrono 3 Kit  
3 kits are required to suspend a 2mt track



## **DOPPIA ACCENSIONE DEGLI APPARECCHI**

È possibile richiedere la doppia accensione per gli apparecchi in fase d'ordine, questo permette di accendere separatamente i corpi illuminanti.

It is possible to request double switching on for the fixtures when ordering, allowing the products to be switched on separately.



line48

**DIMMERABILI 1-10V**

Versione con driver interno 1-10V  
per dimmerazione da 0% a 100%.

With internal 1-10V driver  
for dimming from 0% to 100%.

# BARRA LED MAGNETICA - 30cm

## MAGNETIC LED BAR - 30cm

linea48

L'utilizzo di Chip CRI95 garantisce un'elevata qualità della luce rendendo i colori vivaci e fedeli alla realtà.  
The CRI95 Chip LED guarantees an high quality of light and a perfect colour rendering.

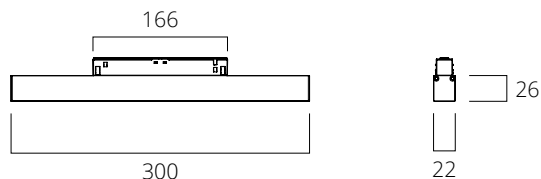

- Corpo in estrusione di alluminio verniciato a polveri
- Schermo in policarbonato opaco diffondente
- LED durata utile: 50 000 (h) L90
- Apparecchio IP20
- Chip CRI95 e 3 Step MacAdam

- Body in extruded aluminum powder coated
- Polycarbonate opal screen
- LED life 50 000 (h) L90
- IP20 protection degree
- CRI95 and 3 Step MacAdam chip LED



CODICE CODE	LUNGHEZZA LENGTH	COLORE BARRA BAR COLOR	DC DC	CONSUMO POWER	LUMEN LUMEN	COLORE COLOR	LISTINO PRICE
MG300LBH/NE	30 cm	NERO - BLACK	48 V	7,2 W	695	2700 K	80 €
MG300LBH/BI	30 cm	BIANCO - WHITE	48 V	7,2 W	695	2700 K	80 €
MG300LBC/NE	30 cm	NERO - BLACK	48 V	7,2 W	715	3000 K	80 €
MG300LBC/BI	30 cm	BIANCO - WHITE	48 V	7,2 W	715	3000 K	80 €
MG300LBN/NE	30 cm	NERO - BLACK	48 V	7,2 W	735	4000 K	80 €
MG300LBN/BI	30 cm	BIANCO - WHITE	48 V	7,2 W	735	4000 K	80 €



Luce fredda 6000 K su richiesta  
6000 K cold light on request

### MAGGIORAZIONI CUSTOM



**DOPPIA ACCENSIONE** - € 18  
Double Switching



**ALIMENTATORE DIMMERABILE 1-10V** - € 65  
1-10V dimmable power supply



**ALIMENTATORE DALI** - € 70  
DALI power supply

### CURVA FOTOMETRICA - PHOTOMETRIC CURVE

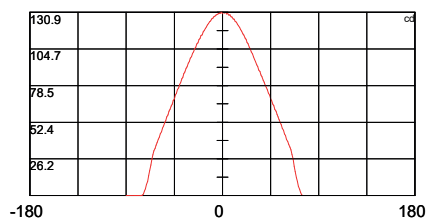
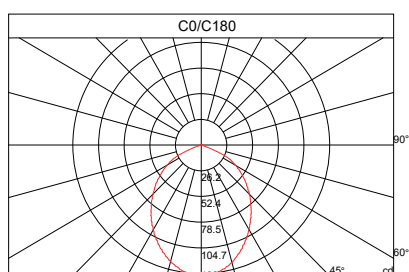



L'utilizzo di Chip CRI95 garantisce un'elevata qualità della luce rendendo i colori vivaci e fedeli alla realtà.  
The CRI95 Chip LED guarantees an high quality of light and a perfect colour rendering.

line48

## BARRA LED MAGNETICA - 60cm MAGNETIC LED BAR - 60cm

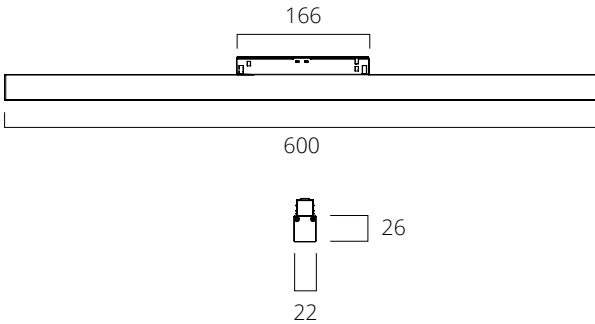

- Corpo in estrusione di alluminio verniciato a polveri
- Schermo in policarbonato opaco diffondente
- LED durata utile: 50 000 (h) L90
- Apparecchio IP20
- Chip CRI95 e 3 Step MacAdam

- Body in extruded aluminum powder coated
- Polycarbonate opal screen
- LED life 50 000 (h) L90
- IP20 protection degree
- CRI95 and 3 Step MacAdam chip LED



CODICE CODE	LUNGHEZZA LENGTH	COLORE BARRA BAR COLOR	DC DC	CONSUMO POWER	LUMEN LUMEN	COLORE COLOR	LISTINO PRICE
MG600LBH/NE	60 cm	NERO - BLACK	48 V	14,4 W	1391	2700 K	100 €
MG600LBH/BI	60 cm	BIANCO - WHITE	48 V	14,4 W	1391	2700 K	100 €
MG600LBC/NE	60 cm	NERO - BLACK	48 V	14,4 W	1430	3000 K	100 €
MG600LBC/BI	60 cm	BIANCO - WHITE	48 V	14,4 W	1430	3000 K	100 €
MG600LBN/NE	60 cm	NERO - BLACK	48 V	14,4 W	1470	4000 K	100 €
MG600LBN/BI	60 cm	BIANCO - WHITE	48 V	14,4 W	1470	4000 K	100 €



Luce fredda 6000 K su richiesta  
6000 K cold light on request

### MAGGIORAZIONI CUSTOM



**DOPPIA ACCENSIONE** - € 18  
Double Switching



**ALIMENTATORE DIMMERABILE 1-10V** - € 65  
1-10V dimmable power supply



**ALIMENTATORE DALI** - € 70  
DALI power supply

### CURVA FOTOMETRICA - PHOTOMETRIC CURVE

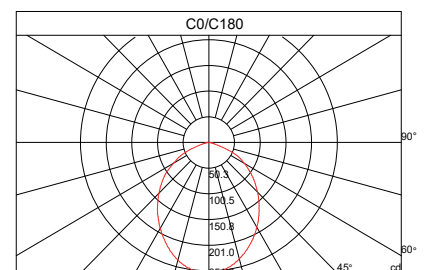
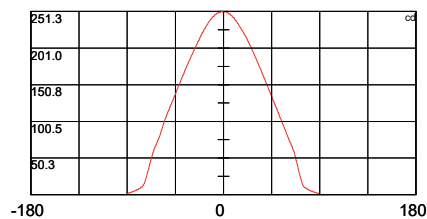

# BARRA LED MAGNETICA - 120cm

## MAGNETIC LED BAR - 120cm

linea48

L'utilizzo di Chip CRI95 garantisce un'elevata qualità della luce rendendo i colori vivaci e fedeli alla realtà.  
The CRI95 Chip LED guarantee an high quality of light and a perfect colour rendering.

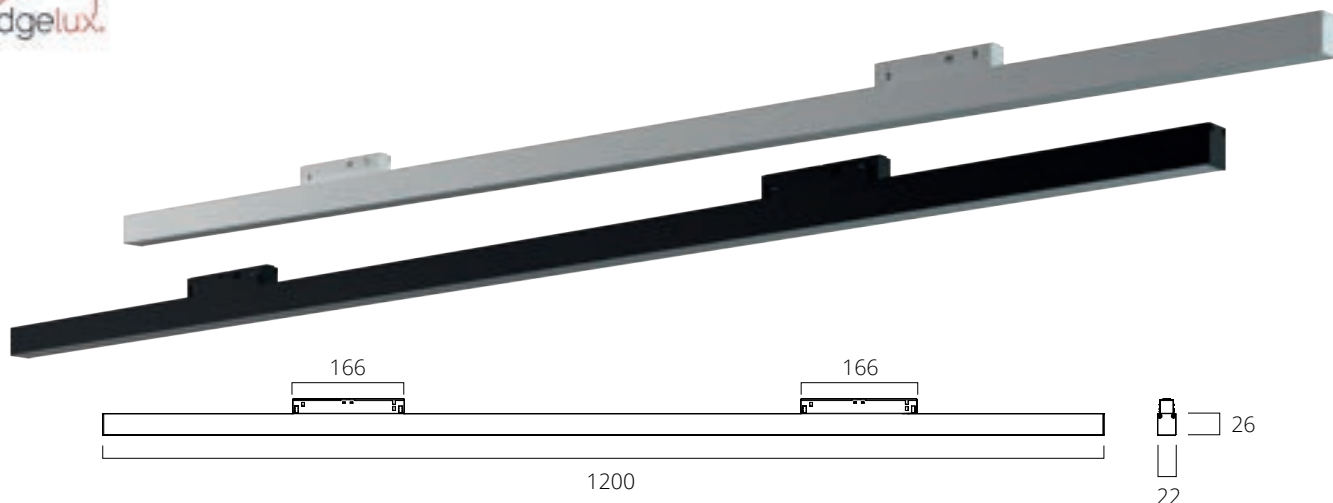

- Corpo in estrusione di alluminio verniciato a polveri
- Schermo in policarbonato opaco diffondente
- LED durata utile: 50 000 (h) L90
- Apparecchio IP20
- Chip CRI95 e 3 Step MacAdam

- Body in extruded aluminum powder coated
- Polycarbonate opal screen
- LED life 50 000 (h) L90
- IP20 protection degree
- CRI95 and 3 Step MacAdam chip LED



CODICE CODE	LUNGHEZZA LENGTH	COLORE BARRA BAR COLOR	DC DC	CONSUMO POWER	LUMEN LUMEN	COLORE COLOR	LISTINO PRICE
MG1200LBH/NE	120 cm	NERO - BLACK	48 V	28,8 W	2783	2700 K	175 €
MG1200LBH/BI	120 cm	BIANCO - WHITE	48 V	28,8 W	2783	2700 K	175 €
MG1200LBC/NE	120 cm	NERO - BLACK	48 V	28,8 W	2861	3000 K	175 €
MG1200LBC/BI	120 cm	BIANCO - WHITE	48 V	28,8 W	2861	3000 K	175 €
MG1200LBN/NE	120 cm	NERO - BLACK	48 V	28,8 W	2940	4000 K	175 €
MG1200LBN/BI	120 cm	BIANCO - WHITE	48 V	28,8 W	2940	4000 K	175 €



Luce fredda 6000 K su richiesta  
6000 K cold light on request

### MAGGIORAZIONI CUSTOM



**DOPIA ACCENSIONE - € 18**  
Double Switching



**ALIMENTATORE DIMMERABILE 1-10V - € 65**  
1-10V dimmable power supply



**ALIMENTATORE DALI - € 70**  
DALI power supply

### CURVA FOTOMETRICA - PHOTOMETRIC CURVE

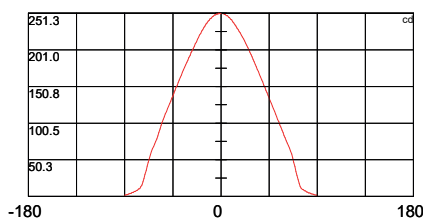
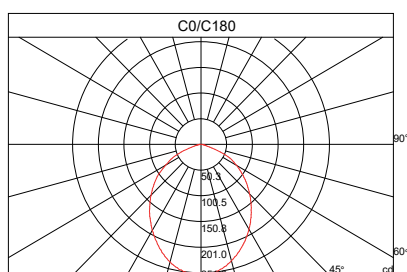



L'utilizzo di Chip CRI95 garantisce un'elevata qualità della luce rendendo i colori vivaci e fedeli alla realtà.  
The CRI95 Chip LED guarantee an high quality of light and a perfect colour rendering.

line48

# DARK LIGHT MAGNETICA - 6W MAGNETIC DARK LIGHT - 6W

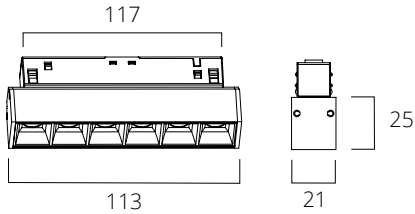

- Corpo in estrusione di alluminio verniciato a polveri
- Fascio d'apertura 24°
- LED durata utile: 50 000 (h) L90
- Apparecchio IP20
- Chip CRI95 e 3 Step MacAdam

- Body in extruded aluminum powder coated
- 24° beam angle lens
- LED life 50 000 (h) L90
- IP20 protection degree
- CRI95 and 3 Step MacAdam chip LED



CODICE CODE	COLORE COLOR	DC DC	CONSUMO POWER	LUMEN LUMEN	COLORE COLOR	LISTINO PRICE
MG06LBH/NE	NERO - BLACK	48 V	6 W	526	2700 K	85 €
MG06LBH/BI	BIANCO - WHITE	48 V	6 W	526	2700 K	85 €
MG06LBC/NE	NERO - BLACK	48 V	6 W	550	3000 K	85 €
MG06LBC/BI	BIANCO - WHITE	48 V	6 W	550	3000 K	85 €
MG06LBN/NE	NERO - BLACK	48 V	6 W	583	4000 K	85 €
MG06LBN/BI	BIANCO - WHITE	48 V	6 W	583	4000 K	85 €

## MAGGIORAZIONI CUSTOM



**DOPPIA ACCENSIONE - € 18**  
Double Switching



**ALIMENTATORE DIMMERABILE 1-10V - € 65**  
1-10V dimmable power supply



**ALIMENTATORE DALI - € 70**  
DALI power supply

## CONO DI LUCE 24° - 24° CONE OF LIGHT

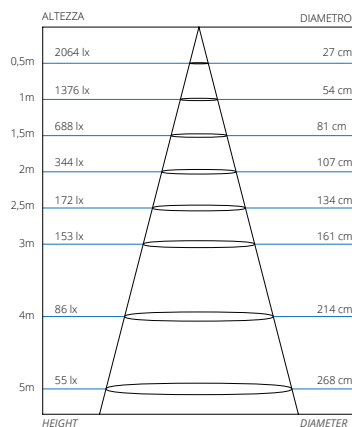

## CURVA FOTOMETRICA - PHOTOMETRIC CURVE

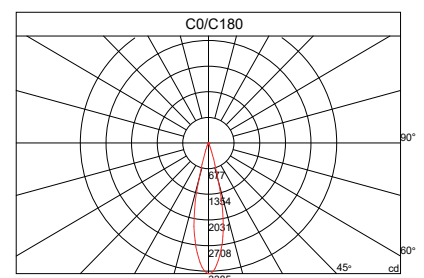
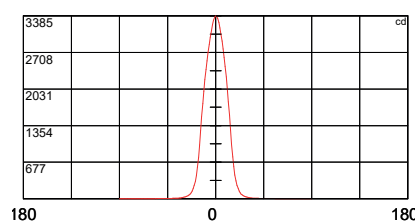

# DARK LIGHT MAGNETICA - 12W

## MAGNETIC DARK LIGHT - 12W

linea48

L'utilizzo di Chip CRI95 garantisce un'elevata qualità della luce rendendo i colori vivaci e fedeli alla realtà.  
The CRI95 Chip LED guarantee an high quality of light and a perfect colour rendering.

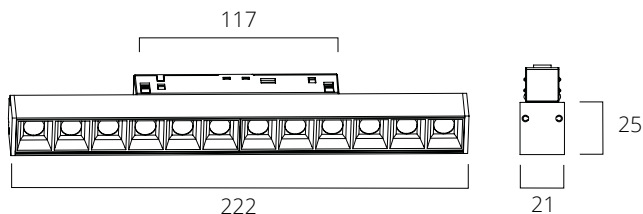

- Corpo in estrusione di alluminio verniciato a polveri
- Fascio d'apertura 24°
- LED durata utile: 50 000 (h) L90
- Apparecchio IP20
- Chip CRI95 e 3 Step MacAdam

- Body in extruded aluminum powder coated
- 24° beam angle lens
- LED life 50 000 (h) L90
- IP20 protection degree
- CRI95 and 3 Step MacAdam chip LED



CODICE CODE	COLORE COLOR	DC DC	CONSUMO POWER	LUMEN LUMEN	COLORE COLOR	LISTINO PRICE
MG12LBH/NE	NERO - BLACK	48 V	12 W	1052	2700 K	100 €
MG12LBH/BI	BIANCO - WHITE	48 V	12 W	1052	2700 K	100 €
MG12LBC/NE	NERO - BLACK	48 V	12 W	1100	3000 K	100 €
MG12LBC/BI	BIANCO - WHITE	48 V	12 W	1100	3000 K	100 €
MG12LBN/NE	NERO - BLACK	48 V	12 W	1166	4000 K	100 €
MG12LBN/BI	BIANCO - WHITE	48 V	12 W	1166	4000 K	100 €

### MAGGIORAZIONI CUSTOM



**DOPPIA ACCENSIONE** - € 18  
Double Switching



**ALIMENTATORE DIMMERABILE 1-10V** - € 65  
1-10V dimmable power supply



**ALIMENTATORE DALI** - € 70  
DALI power supply

### CONO DI LUCE 24° - 24° CONE OF LIGHT

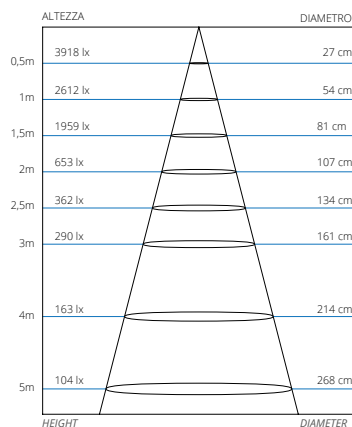

### CURVA FOTOMETRICA - PHOTOMETRIC CURVE

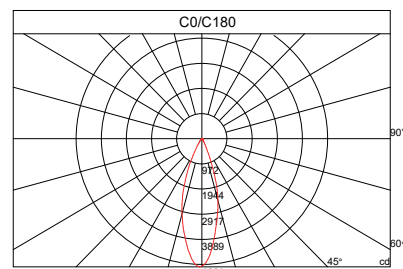
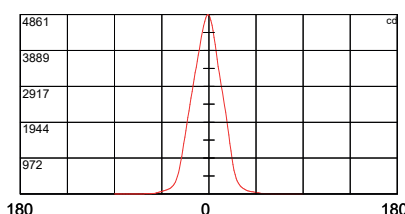





L'utilizzo di Chip CRI95 garantisce un'elevata qualità della luce rendendo i colori vivaci e fedeli alla realtà.  
The CRI95 Chip LED guarantees an high quality of light and a perfect colour rendering.

line40

# DARK LIGHT MAGNETICA ORIENTABILE - 6W ADJUSTABLE MAGNETIC DARK LIGHT - 6W

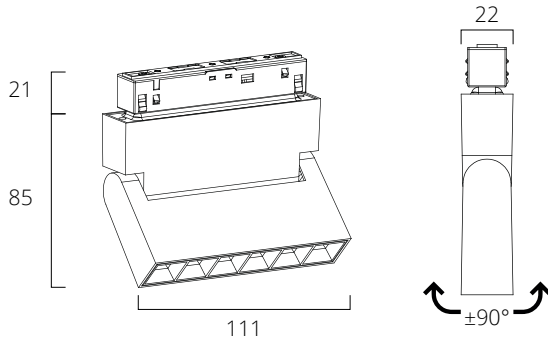

- Corpo in estrusione di alluminio verniciato a polveri
- Fascio d'apertura 24°
- LED durata utile: 50 000 (h) L90
- Apparecchio IP20
- Chip CRI95 e 3 Step MacAdam

- Body in extruded aluminum powder coated
- 24° beam angle lens
- LED life 50 000 (h) L90
- IP20 protection degree
- CRI95 and 3 Step MacAdam chip LED



CODICE CODE	COLORE COLOR	DC DC	CONSUMO POWER	LUMEN LUMEN	COLORE COLOR	LISTINO PRICE
MGA06LBH/NE	NERO - BLACK	48 V	6 W	526	2700 K	115 €
MGA06LBH/BI	BIANCO - WHITE	48 V	6 W	526	2700 K	115 €
MGA06LBC/NE	NERO - BLACK	48 V	6 W	550	3000 K	115 €
MGA06LBC/BI	BIANCO - WHITE	48 V	6 W	550	3000 K	115 €
MGA06LBN/NE	NERO - BLACK	48 V	6 W	583	4000 K	115 €
MGA06LBN/BI	BIANCO - WHITE	48 V	6 W	583	4000 K	115 €

## MAGGIORAZIONI CUSTOM



**DOPPIA ACCENSIONE - € 18**  
Double Switching



**ALIMENTATORE DIMMERABILE 1-10V - € 65**  
1-10V dimmable power supply



**ALIMENTATORE DALI - € 70**  
DALI power supply

## CONO DI LUCE 24° - 24° CONE OF LIGHT

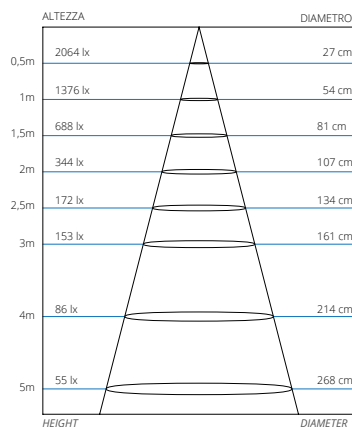

## CURVA FOTOMETRICA - PHOTOMETRIC CURVE

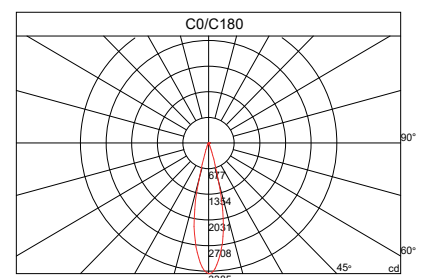
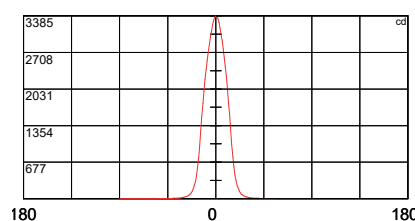

# DARK LIGHT MAGNETICA ORIENTABILE - 12W ADJUSTABLE MAGNETIC DARK LIGHT - 12W

linea48

L'utilizzo di Chip CRI95 garantisce un'elevata qualità della luce rendendo i colori vivaci e fedeli alla realtà.  
The CRI95 Chip LED guarantee an high quality of light and a perfect colour rendering.

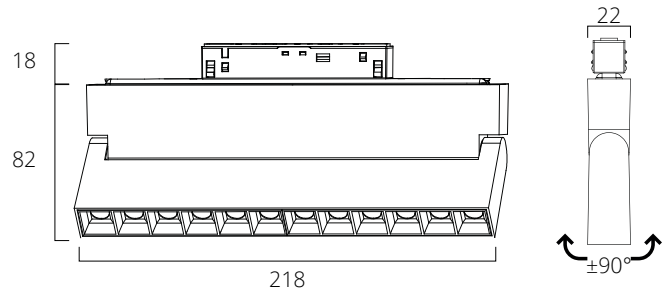

- Corpo in estrusione di alluminio verniciato a polveri
- Fascio d'apertura 24°
- LED durata utile: 50 000 (h) L90
- Apparecchio IP20
- Chip CRI95 e 3 Step MacAdam

- Body in extruded aluminum powder coated
- 24° beam angle lens
- LED life 50 000 (h) L90
- IP20 protection degree
- CRI95 and 3 Step MacAdam chip LED



CODICE CODE	COLORE COLOR	DC DC	CONSUMO POWER	LUMEN LUMEN	COLORE COLOR	LISTINO PRICE
MGA12LBH/NE	NERO - BLACK	48 V	12 W	1052	2700 K	140 €
MGA12LBH/BI	BIANCO - WHITE	48 V	12 W	1052	2700 K	140 €
MGA12LBC/NE	NERO - BLACK	48 V	12 W	1100	3000 K	140 €
MGA12LBC/BI	BIANCO - WHITE	48 V	12 W	1100	3000 K	140 €
MGA12LBN/NE	NERO - BLACK	48 V	12 W	1166	4000 K	140 €
MGA12LBN/BI	BIANCO - WHITE	48 V	12 W	1166	4000 K	140 €

## MAGGIORAZIONI CUSTOM



**DOPPIA ACCENSIONE - € 18**  
Double Switching



**ALIMENTATORE DIMMERABILE 1-10V - € 65**  
1-10V dimmable power supply



**ALIMENTATORE DALI - € 70**  
DALI power supply

## CONO DI LUCE 24° - 24° CONE OF LIGHT

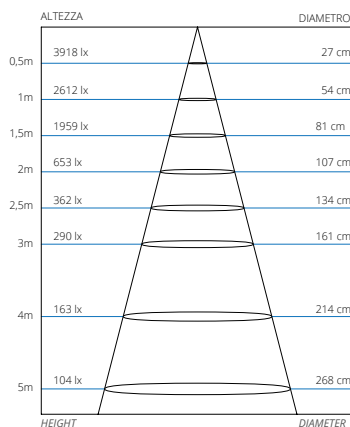

## CURVA FOTOMETRICA - PHOTOMETRIC CURVE

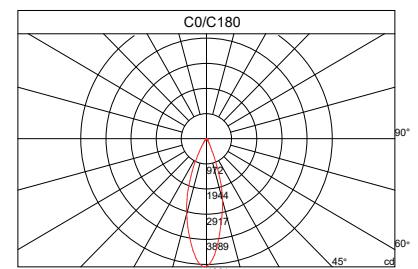
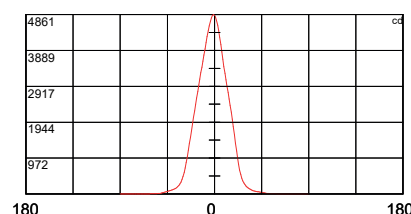



L'utilizzo di Chip CRI95 garantisce un'elevata qualità della luce rendendo i colori vivaci e fedeli alla realtà.  
The CRI95 Chip LED guarantee an high quality of light and a perfect colour rendering.

line40

## TUBO MAGNETICO - 6W MAGNETIC TUBE - 6W

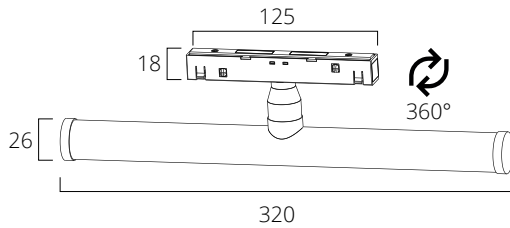

- Corpo in estrusione di alluminio verniciato a polveri
- Fascio d'apertura 24°
- LED durata utile: 50 000 (h) L90
- Apparecchio IP20
- Chip CRI95 e 3 Step MacAdam

- Body in extruded aluminum powder coated
- 24° beam angle lens
- LED life 50 000 (h) L90
- IP20 protection degree
- CRI95 and 3 Step MacAdam chip LED



CODICE CODE	COLORE COLOR	DC DC	CONSUMO POWER	LUMEN LUMEN	COLORE COLOR	LISTINO PRICE
MGT06LBH/NE	NERO - BLACK	48 V	6 W	653	2700 K	70 €
MGT06LBH/BI	BIANCO - WHITE	48 V	6 W	653	2700 K	70 €
MGT06LBC/NE	NERO - BLACK	48 V	6 W	672	3000 K	70 €
MGT06LBC/BI	BIANCO - WHITE	48 V	6 W	672	3000 K	70 €
MGT06LBN/NE	NERO - BLACK	48 V	6 W	690	4000 K	70 €
MGT06LBN/BI	BIANCO - WHITE	48 V	6 W	690	4000 K	70 €

### MAGGIORAZIONI CUSTOM



**DOPPIA ACCENSIONE** - € 18  
Double Switching



**ALIMENTATORE DIMMERABILE 1-10V** - € 65  
1-10V dimmable power supply



**ALIMENTATORE DALI** - € 70  
DALI power supply

### CURVA FOTOMETRICA - PHOTOMETRIC CURVE

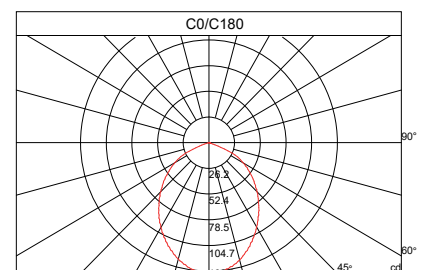
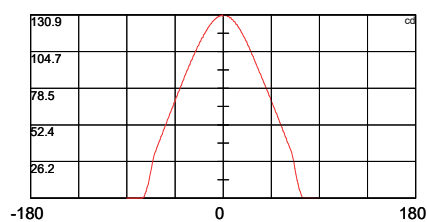

# TUBO MAGNETICO - 12W

## MAGNETIC TUBE - 12W

linea48

L'utilizzo di Chip CRI95 garantisce un'elevata qualità della luce rendendo i colori vivaci e fedeli alla realtà.  
The CRI95 Chip LED guarantee an high quality of light and a perfect colour rendering.



bridgelux

NEW

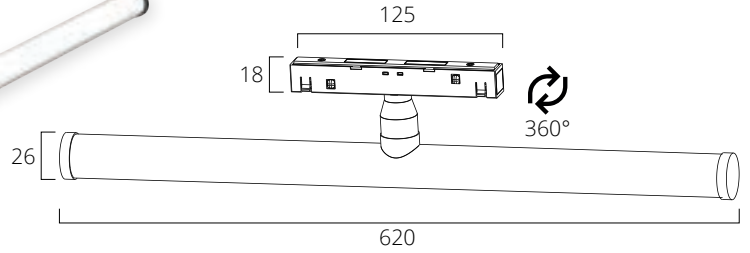

- Corpo in estrusione di alluminio verniciato a polveri
- Fascio d'apertura 24°
- LED durata utile: 50 000 (h) L90
- Apparecchio IP20
- Chip CRI95 e 3 Step MacAdam

- Body in extruded aluminum powder coated
- 24° beam angle lens
- LED life 50 000 (h) L90
- IP20 protection degree
- CRI95 and 3 Step MacAdam chip LED

2700K

CODICE CODE	COLORE COLOR	DC DC	CONSUMO POWER	LUMEN LUMEN	COLORE COLOR	LISTINO PRICE
MGT12LBH/NE	NERO - BLACK	48 V	12 W	1310	2700 K	90 €
MGT12LBH/BI	BIANCO - WHITE	48 V	12 W	1310	2700 K	90 €
MGT12LBC/NE	NERO - BLACK	48 V	12 W	1345	3000 K	90 €
MGT12LBC/BI	BIANCO - WHITE	48 V	12 W	1345	3000 K	90 €
MGT12LBN/NE	NERO - BLACK	48 V	12 W	1385	4000 K	90 €
MGT12LBN/BI	BIANCO - WHITE	48 V	12 W	1385	4000 K	90 €

### MAGGIORAZIONI CUSTOM



**DOPPIA ACCENSIONE** - € 18  
Double Switching



**ALIMENTATORE DIMMERABILE 1-10V** - € 65  
1-10V dimmable power supply



**ALIMENTATORE DALI** - € 70  
DALI power supply

### CURVA FOTOMETRICA - PHOTOMETRIC CURVE

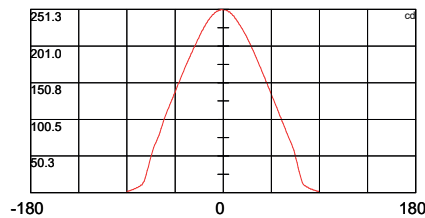
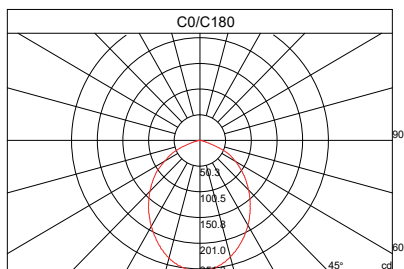



L'utilizzo di Chip CRI95 garantisce un'elevata qualità della luce rendendo i colori vivaci e fedeli alla realtà.  
The CRI95 Chip LED guarantee an high quality of light and a perfect colour rendering.

line48

## SPOT MAGNETICO - 5W MAGNETIC SPOTLIGHT - 5W

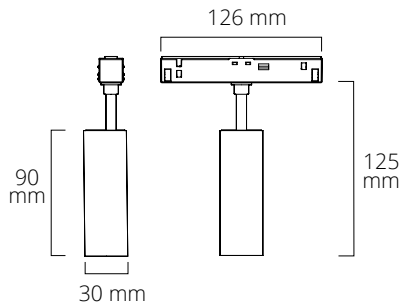

- Corpo in pressofusione di alluminio verniciato a polveri
- Fascio d'apertura standard 36°
- LED durata utile: 50 000 (h) L90
- Apparecchio IP20
- Chip CRI95 e 3 Step MacAdam

- Body in die cast aluminum powder coated
- 36° standard beam angle lens
- LED life 50 000 (h) L90
- IP20 protection degree
- CRI95 and 3 Step MacAdam chip LED



CODICE CODE	COLORE COLOR	DC DC	CONSUMO POWER	LUMEN LUMEN	COLORE COLOR	LISTINO PRICE
MG05LBH/NE	NERO - BLACK	48 V	5 W	480	2700 K	71 €
MG05LBH/BI	BIANCO - WHITE	48 V	5 W	480	2700 K	71 €
MG05LBC/NE	NERO - BLACK	48 V	5 W	495	3000 K	71 €
MG05LBC/BI	BIANCO - WHITE	48 V	5 W	495	3000 K	71 €
MG05LBN/NE	NERO - BLACK	48 V	5 W	510	4000 K	71 €
MG05LBN/BI	BIANCO - WHITE	48 V	5 W	510	4000 K	71 €



Luce fredda 6000 K su richiesta  
6000 K cold light on request

### MAGGIORAZIONI CUSTOM



**DOPPIA ACCENSIONE** - € 18  
Double Switching



**ALIMENTATORE DIMMERABILE 1-10V** - € 65  
1-10V dimmable power supply



**ALIMENTATORE DALI** - € 70  
DALI power supply



**Lenti** - € 8  
Lens

### CONO DI LUCE 36° 36° CONE OF LIGHT

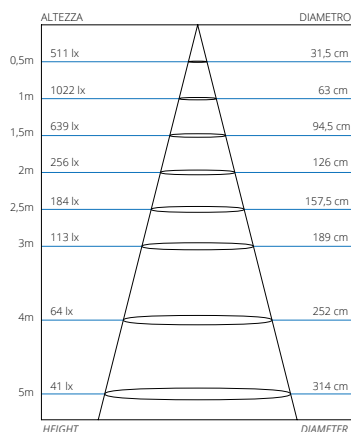

### CURVA FOTOMETRICA PHOTOMETRIC CURVE

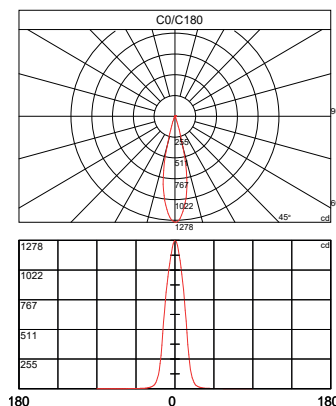

### FASCI D'APERTURA OPENING BEAMS

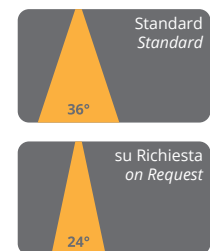

# SPOT MAGNETICO - 10W MAGNETIC SPOTLIGHT - 10W

linea48

L'utilizzo di Chip CRI95 garantisce un'elevata qualità della luce rendendo i colori vivaci e fedeli alla realtà.  
The CRI95 Chip LED guarantee a high quality of light and a perfect colour rendering.

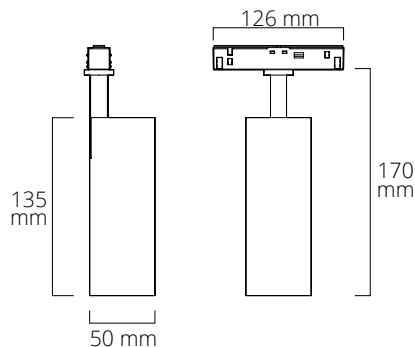

- Corpo in pressofusione di alluminio verniciato a polveri
- Fascio d'apertura standard 36°
- LED durata utile: 50 000 (h) L90
- Apparecchio IP20
- Chip CRI95 e 3 Step MacAdam

- Body in die cast aluminum powder coated
- 36° standard beam angle lens
- LED life 50 000 (h) L90
- IP20 protection degree
- CRI95 and 3 Step MacAdam chip LED



CODICE CODE	COLORE COLOR	DC DC	CONSUMO POWER	LUMEN LUMEN	COLORE COLOR	LISTINO PRICE
MG10LBH/NE	NERO - BLACK	48 V	10 W	862	2700 K	132,50 €
MG10LBH/BI	BIANCO - WHITE	48 V	10 W	862	2700 K	132,50 €
MG10LBC/NE	NERO - BLACK	48 V	10 W	901	3000 K	132,50 €
MG10LBC/BI	BIANCO - WHITE	48 V	10 W	901	3000 K	132,50 €
MG10LBN/NE	NERO - BLACK	48 V	10 W	940	4000 K	132,50 €
MG10LBN/BI	BIANCO - WHITE	48 V	10 W	940	4000 K	132,50 €



Luce fredda 6000 K su richiesta  
6000 K cold light on request

## MAGGIORAZIONI CUSTOM



**DOPPIA ACCENSIONE** - € 18  
Double Switching



**ALIMENTATORE DIMMERABILE 1-10V** - € 65  
1-10V dimmable power supply



**ALIMENTATORE DALI** - € 70  
DALI power supply



**Lenti** - € 8  
Lens

## CONO DI LUCE 36° 36° CONE OF LIGHT

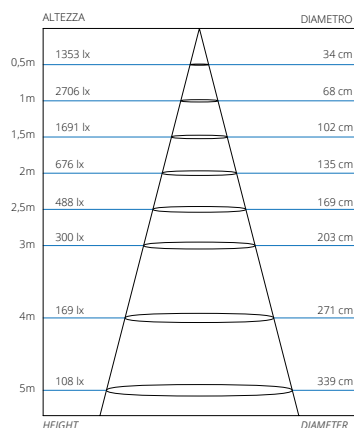

## CURVA FOTOMETRICA PHOTOMETRIC CURVE

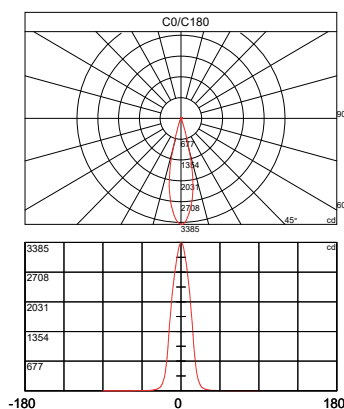

## FASCI D'APERTURA OPENING BEAMS

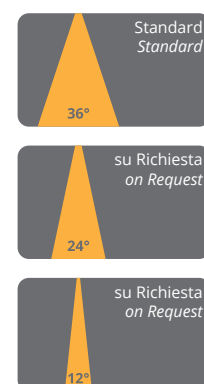



L'utilizzo di Chip CRI95 garantisce un'elevata qualità della luce rendendo i colori vivaci e fedeli alla realtà.  
The CRI95 Chip LED guarantees an high quality of light and a perfect colour rendering.

line40

## SPOT MAGNETICO - 20W MAGNETIC SPOTLIGHT - 20W

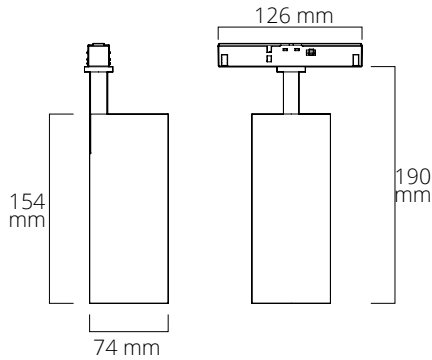

- Corpo in pressofusione di alluminio verniciato a polveri
- Fascio d'apertura standard 36°
- LED durata utile: 50 000 (h) L90
- Apparecchio IP20
- Chip CRI95 e 3 Step MacAdam

- Body in die cast aluminum powder coated
- 36° standard beam angle lens
- LED life 50 000 (h) L90
- IP20 protection degree
- CRI95 and 3 Step MacAdam chip LED



CODICE CODE	COLORE COLOR	DC DC	CONSUMO POWER	LUMEN LUMEN	COLORE COLOR	LISTINO PRICE
MG20LBH/NE	NERO - BLACK	48 V	20 W	1960	2700 K	205 €
MG20LBH/BI	BIANCO - WHITE	48 V	20 W	1960	2700 K	205 €
MG20LBC/NE	NERO - BLACK	48 V	20 W	2010	3000 K	205 €
MG20LBC/BI	BIANCO - WHITE	48 V	20 W	2010	3000 K	205 €
MG20LBN/NE	NERO - BLACK	48 V	20 W	2058	4000 K	205 €
MG20LBN/BI	BIANCO - WHITE	48 V	20 W	2058	4000 K	205 €



Luce fredda 6000 K su richiesta  
6000 K cold light on request

### MAGGIORAZIONI CUSTOM



**DOPPIA ACCENSIONE** - € 18  
Double Switching



**ALIMENTATORE DIMMERABILE 1-10V** - € 65  
1-10V dimmable power supply



**ALIMENTATORE DALI** - € 70  
DALI power supply



**Lenti** - € 8  
Lens

### CONO DI LUCE 36° 36° CONE OF LIGHT

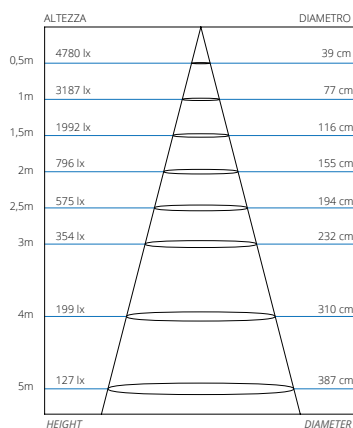

### CURVA FOTOMETRICA PHOTOMETRIC CURVE

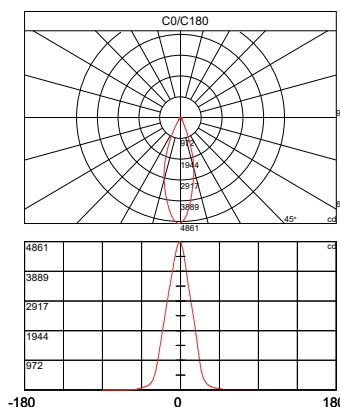

### FASCI D'APERTURA OPENING BEAMS

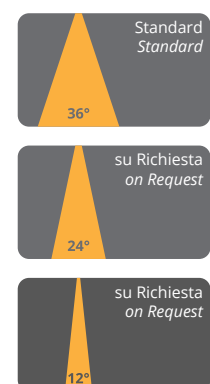

# SPOT MAGNETICO - 30W MAGNETIC SPOTLIGHT - 30W

linea48

L'utilizzo di Chip CRI95 garantisce un'elevata qualità della luce rendendo i colori vivaci e fedeli alla realtà.  
The CRI95 Chip LED guarantee a high quality of light and a perfect colour rendering.

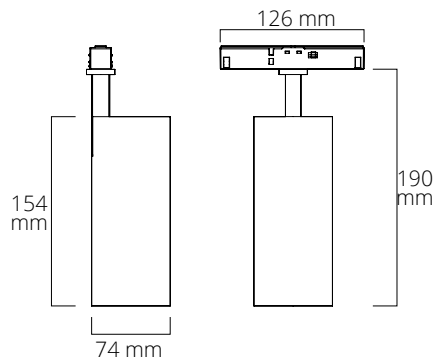

- Corpo in pressofusione di alluminio verniciato a polveri
- Fascio d'apertura standard 36°
- LED durata utile: 50 000 (h) L90
- Apparecchio IP20
- Chip CRI95 e 3 Step MacAdam

- Body in die cast aluminum powder coated
- 36° standard beam angle lens
- LED life 50 000 (h) L90
- IP20 protection degree
- CRI95 and 3 Step MacAdam chip LED



CODICE CODE	COLORE COLOR	DC DC	CONSUMO POWER	LUMEN LUMEN	COLORE COLOR	LISTINO PRICE
MG30LBH/NE	NERO - BLACK	48 V	30 W	2860	2700 K	220 €
MG30LBH/BI	BIANCO - WHITE	48 V	30 W	2860	2700 K	220 €
MG30LBC/NE	NERO - BLACK	48 V	30 W	2910	3000 K	220 €
MG30LBC/BI	BIANCO - WHITE	48 V	30 W	2910	3000 K	220 €
MG30LBN/NE	NERO - BLACK	48 V	30 W	2958	4000 K	220 €
MG30LBN/BI	BIANCO - WHITE	48 V	30 W	2958	4000 K	220 €



Luce fredda 6000 K su richiesta  
6000 K cold light on request

## MAGGIORAZIONI CUSTOM



**DOPPIA ACCENSIONE** - € 18  
Double Switching



**ALIMENTATORE DIMMERABILE 1-10V** - € 65  
1-10V dimmable power supply



**ALIMENTATORE DALI** - € 70  
DALI power supply



**Lenti** - € 8  
Lens

## CONO DI LUCE 36° 36° CONE OF LIGHT

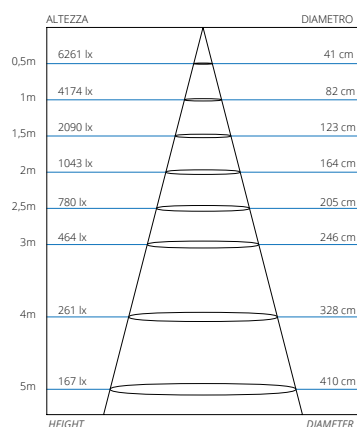

## CURVA FOTOMETRICA PHOTOMETRIC CURVE

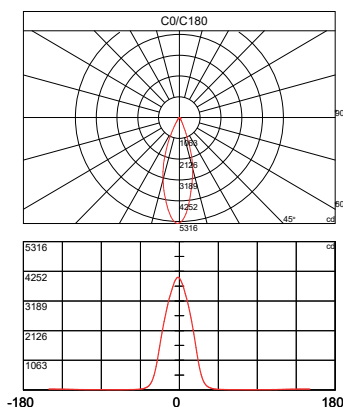

## FASCI D'APERTURA OPENING BEAMS

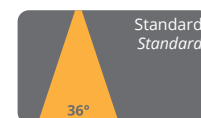





L'utilizzo di Chip CRI95 garantisce un'elevata qualità della luce rendendo i colori vivaci e fedeli alla realtà.  
The CRI95 Chip LED guarantees an high quality of light and a perfect colour rendering.

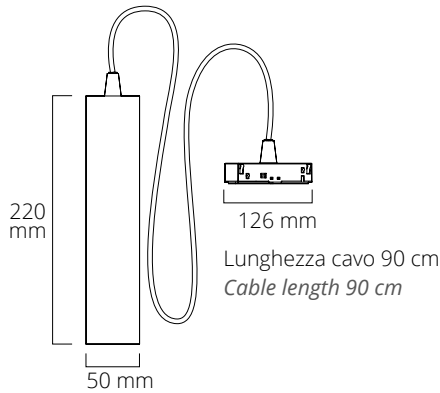

linea40

## SPOT A SOSPENSIONE MAGNETICO - 10W MAGNETIC SUSPENDED SPOTLIGHT - 10W



- Corpo in pressofusione di alluminio verniciato a polveri
- Fascio d'apertura standard 36°
- LED durata utile: 50 000 (h) L90
- Apparecchio IP20
- Chip CRI95 e 3 Step MacAdam

- Body in die cast aluminum powder coated
- 36° standard beam angle lens
- LED life 50 000 (h) L90
- IP20 protection degree
- CRI95 and 3 Step MacAdam chip LED



CODICE CODE	COLORE COLOR	DC DC	CONSUMO POWER	LUMEN LUMEN	COLORE COLOR	LISTINO PRICE
MGS10LBH/NE	NERO - BLACK	48 V	10 W	862	2700 K	165 €
MGS10LBH/BI	BIANCO - WHITE	48 V	10 W	862	2700 K	165 €
MGS10LBC/NE	NERO - BLACK	48 V	10 W	901	3000 K	165 €
MGS10LBC/BI	BIANCO - WHITE	48 V	10 W	901	3000 K	165 €
MGS10LBN/NE	NERO - BLACK	48 V	10 W	940	4000 K	165 €
MGS10LBN/BI	BIANCO - WHITE	48 V	10 W	940	4000 K	165 €



Luce fredda 6000 K su richiesta  
6000 K cold light on request

### MAGGIORAZIONI CUSTOM



**DOPPIA ACCENSIONE** - € 18  
Double Switching



**ALIMENTATORE DIMMERABILE 1-10V** - € 65  
1-10V dimmable power supply



**ALIMENTATORE DALI** - € 70  
DALI power supply



**Lenti** - € 8  
Lens

### CONO DI LUCE 36° 36° CONE OF LIGHT

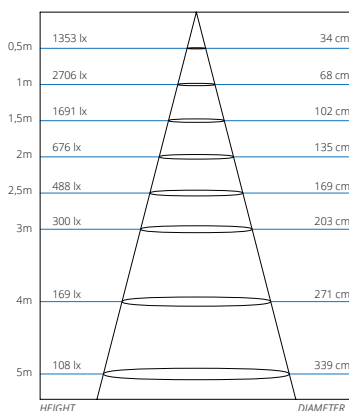

### CURVA FOTOMETRICA PHOTOMETRIC CURVE

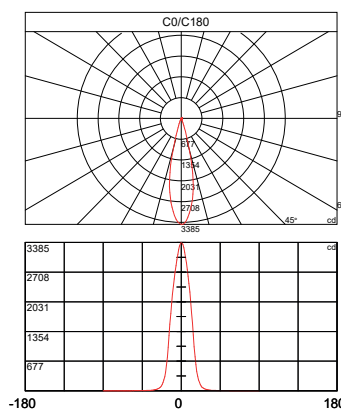

### FASCI D'APERTURA OPENING BEAMS

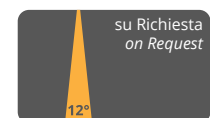
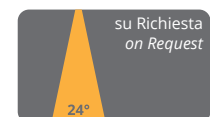
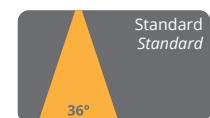

# TRASFORMATORE 48V A SCOMPARSA PER BINARIO MAGNETICO RECESSED 48V POWER SUPPLY FOR MAGNETIC TRACK

line48



Dimensioni: 235x 44 x h 20 mm | Lunghezza cavo: 950 mm

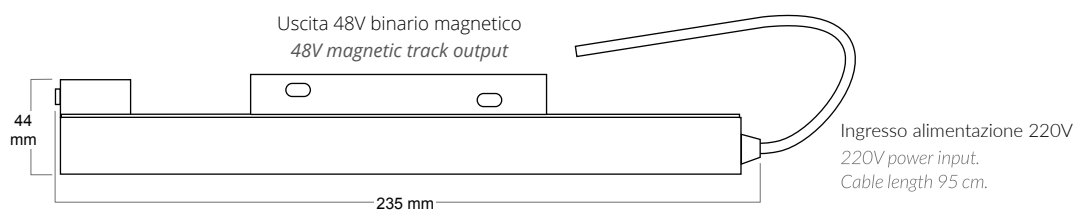

CODICE CODE	CONSUMO POWER	COLORE COLOR	TENSIONE VOLTAGE	IP IP	LISTINO PRICE
TR48100/MG/NE	100W	NERO - BLACK	48V	67	150 €
TR48100/MG/BI	100W	BIANCO - WHITE	48V	67	150 €

 **DOPPIA ACCENSIONE** - € 18  
Double Switching



Dimensioni: 314 x 42 x h 20 mm | Lunghezza cavo: 950 mm

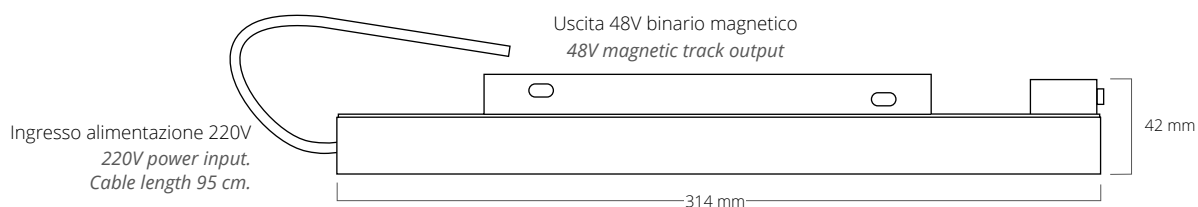

CODICE CODE	CONSUMO POWER	COLORE COLOR	TENSIONE VOLTAGE	IP IP	LISTINO PRICE
TR48200/MG/NE	200W	NERO - BLACK	48V	67	180 €
TR48200/MG/BI	200W	BIANCO - WHITE	48V	67	180 €

 **DOPPIA ACCENSIONE** - € 18  
Double Switching

I trasformatori a scomparsa non richiedono l'utilizzo della testata di alimentazione in quanto già integrata.  
The retractable transformer does not require the use of the power supply head as it is already integrated.

**TRASFORMATORE 48VDC 100W**



Dimensioni: 188,6 x 46,2 x h 34,4 mm

CODICE	CONSUMO	TENSIONE	IP	LISTINO
TR48100	100W	48V	20	62 €

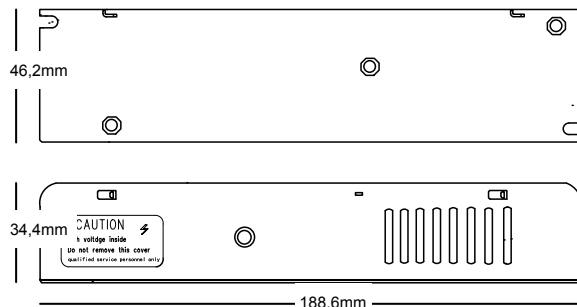

**TRASFORMATORE 48VDC 200W**



Dimensioni: 223,4 x 66,9 x h 39,9 mm

CODICE	CONSUMO	TENSIONE	IP	LISTINO
TR48200	200W	48V	20	85 €

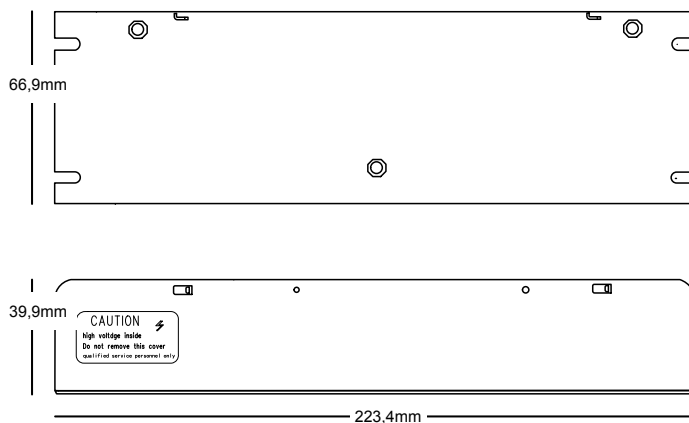

**TRASFORMATORE 48VDC 360W**



Dimensioni: 215 x 114 x h 50 mm

CODICE	CONSUMO	TENSIONE	IP	LISTINO
TR48360	360W	48V	20	135 €

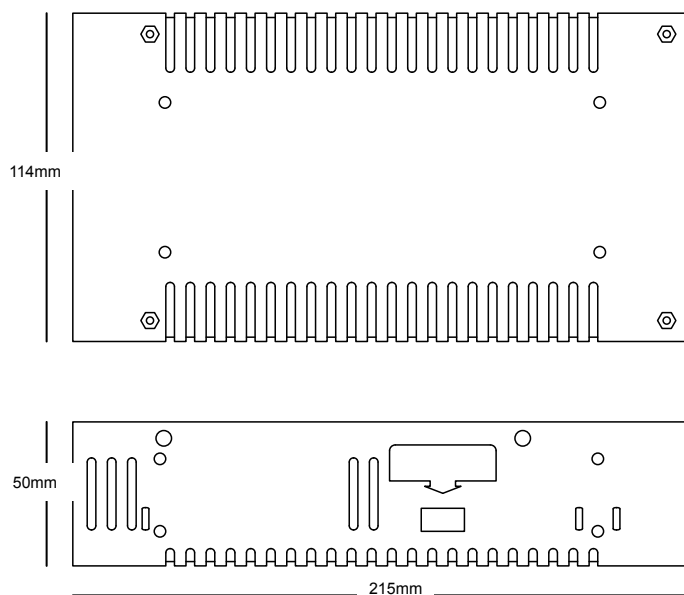

## ACCESSORI PER SPOT MAGNETICI ACCESSORIES FOR MAGNETIC SPOTLIGHT

line48

### RIFLETTORI COLORATI - SPOT MAGNETICO 5W COLORED REFLECTORS - MAGNETIC SPOTLIGHT 5W

- Riflettore in pressofusione di alluminio verniciato a polveri
- Nuove colorazioni disponibili: Oro e Argento
- Dimensioni: Diametro 25mm - Profondità 14mm
- *Reflector in die cast aluminum powder coated*
- *New colors available: Gold and Silver*
- *Dimensions: Diameter 25mm - Depth 14mm*

CODICE CODE	COLORE RIFLETTORE REFLECTOR COLOR	LISTINO PRICE
MG05/S	ARGENTO - SILVER	11,50 €*
MG05/G	ORO - GOLD	11,50 €*



### RIFLETTORI COLORATI - SPOT MAGNETICO 10W COLORED REFLECTORS - MAGNETIC SPOTLIGHT 10W

- Riflettore in pressofusione di alluminio verniciato a polveri
- Nuove colorazioni disponibili: Oro e Argento
- Dimensioni: Diametro 45mm - Profondità 15mm
- *Reflector in die cast aluminum powder coated*
- *New colors available: Gold and Silver*
- *Dimensions: Diameter 45mm - Depth 15mm*

CODICE CODE	COLORE RIFLETTORE REFLECTOR COLOR	LISTINO PRICE
MG10/S	ARGENTO - SILVER	16 €*
MG10/G	ORO - GOLD	16 €*



### RIFLETTORI COLORATI - SPOT MAGNETICO 20W/30W COLORED REFLECTORS - MAGNETIC SPOTLIGHT 20W/30W

- Riflettore in pressofusione di alluminio verniciato a polveri
- Nuove colorazioni disponibili: Oro e Argento
- Dimensioni: Diametro 70mm - Profondità 20mm
- *Reflector in die cast aluminum powder coated*
- *New colors available: Gold and Silver*
- *Dimensions: Diameter 70mm - Depth 20mm*

CODICE CODE	COLORE RIFLETTORE REFLECTOR COLOR	LISTINO PRICE
MG20/S	ARGENTO - SILVER	19 €*
MG20/G	ORO - GOLD	19 €*



\*Prezzo riferito all'acquisto del solo riflettore  
\*The price refers to the purchase of the reflector only

GRIGLIA ANTIABBAGLIAMENTO - SPOT MAGNETICO 5W  
ANTI-GLARE GRID - MAGNETIC SPOTLIGHT 5W

- Griglia antiabbagliamento a nido d'ape
- Colorazione disponibile: Nero
- Dimensioni: Diametro 22mm - Profondità 1mm
- *Honeycomb anti-glare grid*
- *Color available: Black*
- *Dimensions: Diameter 22mm - Depth 1mm*

CODICE CODE	COLORE RIFLETTORE REFLECTOR COLOR	LISTINO PRICE
MGR05/NE	NERO - BLACK	14 €*

GRIGLIA ANTIABBAGLIAMENTO - SPOT MAGNETICO 10W  
ANTI-GLARE GRID - MAGNETIC SPOTLIGHT 10W

- Griglia antiabbagliamento a nido d'ape
- Colorazione disponibile: Nero
- Dimensioni: Diametro 38mm - Profondità 2mm
- *Honeycomb anti-glare grid*
- *Color available: Black*
- *Dimensions: Diameter 38mm - Depth 2mm*

CODICE CODE	COLORE RIFLETTORE REFLECTOR COLOR	LISTINO PRICE
MGR10/NE	NERO - BLACK	16 €*

GRIGLIA ANTIABBAGLIAMENTO - SPOT MAGNETICO 20W/30W  
ANTI-GLARE GRID - MAGNETIC SPOTLIGHT 20W/30W

- Griglia antiabbagliamento a nido d'ape
- Colorazione disponibile: Nero
- Dimensioni: Diametro 70mm - Profondità 20mm
- *Honeycomb anti-glare grid*
- *Color available: Black*
- *Dimensions: Diameter 70mm - Depth 20mm*

CODICE CODE	COLORE RIFLETTORE REFLECTOR COLOR	LISTINO PRICE
MGR20/NE	NERO - BLACK	18 €*

\*Prezzo riferito all'acquisto della griglia + riflettore  
\*Price refers to the purchase of the grille + reflector

# SPOT 220V

Il complemento perfetto  
per installazioni del LINE48.

*The perfect complement to LINE48 installations.*

L'alimentazione a 220V garantisce rapidità di installazione.

Il driver integrato nella basetta rende il prodotto adatto a qualsiasi utilizzo con spazi ridotti.

*The 220V power supply ensures quick installation.*

*The driver integrated in the base makes the product suitable for any use with small spaces.*



# SPOT 220V - 5W 220V SPOTLIGHT - 5W



L'utilizzo di Chip CRI95 garantisce un'elevata qualità della luce rendendo i colori vivaci e fedeli alla realtà.  
The CRI95 Chip LED guarantee a high quality of light and a perfect colour rendering.

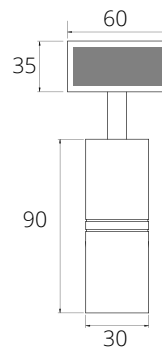

Alimentatore 220V integrato nella basetta  
220V power supply integrated in the base

- Corpo in pressofusione di alluminio verniciato a polveri
- Fascio d'apertura standard 36°
- LED durata utile: 50 000 (h) L90
- Apparecchio IP20
- Chip CRI95 e 3 Step MacAdam

- Body in die cast aluminum powder coated
- 36° standard beam angle lens
- LED life 50 000 (h) L90
- IP20 protection degree
- CRI95 and 3 Step MacAdam chip LED



CODICE CODE	COLORE COLOR	AC AC	CONSUMO POWER	LUMEN LUMEN	COLORE COLOR	LISTINO PRICE
PL05LBH/NE	NERO - BLACK	220 V	5 W	480	2700 K	80 €
PL05LBH/BI	BIANCO - WHITE	220 V	5 W	480	2700 K	80 €
PL05LBC/NE	NERO - BLACK	220 V	5 W	495	3000 K	80 €
PL05LBC/BI	BIANCO - WHITE	220 V	5 W	495	3000 K	80 €
PL05LBN/NE	NERO - BLACK	220 V	5 W	510	4000 K	80 €
PL05LBN/BI	BIANCO - WHITE	220 V	5 W	510	4000 K	80 €



Luce fredda 6000 K su richiesta  
6000 K cold light on request

## MAGGIORAZIONI CUSTOM



Lenti - € 8  
Lens

### CONO DI LUCE 36° 36° CONE OF LIGHT

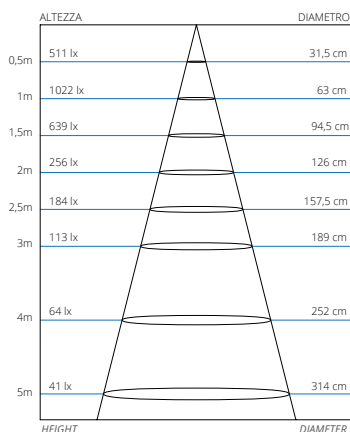

### CURVA FOTOMETRICA PHOTOMETRIC CURVE

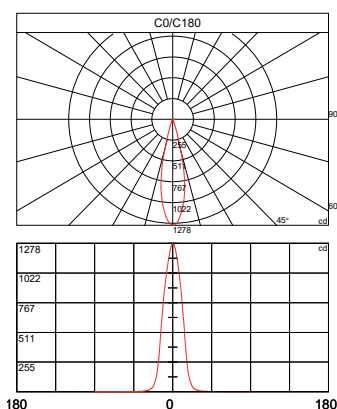

### FASCI D'APERTURA OPENING BEAMS

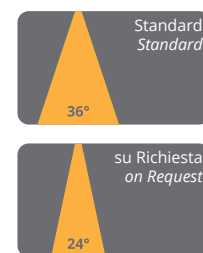





L'utilizzo di Chip CRI95 garantisce un'elevata qualità della luce rendendo i colori vivaci e fedeli alla realtà.  
The CRI95 Chip LED guarantees a high quality of light and a perfect colour rendering.

## SPOT 220V - 10W 220V SPOTLIGHT - 10W

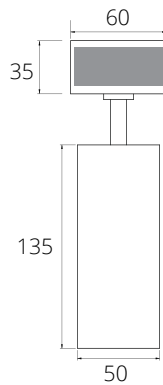

Alimentatore 220V integrato nella basetta  
220V power supply integrated in the base



- Corpo in pressofusione di alluminio verniciato a polveri
- Fascio d'apertura standard 36°
- LED durata utile: 50 000 (h) L90
- Apparecchio IP20
- Chip CRI95 e 3 Step MacAdam

- Body in die cast aluminum powder coated
- 36° standard beam angle lens
- LED life 50 000 (h) L90
- IP20 protection degree
- CRI95 and 3 Step MacAdam chip LED



CODICE CODE	COLORE COLOR	AC AC	CONSUMO POWER	LUMEN LUMEN	COLORE COLOR	LISTINO PRICE
PL10LBH/NE	NERO - BLACK	220 V	10 W	862	2700 K	140 €
PL10LBH/BI	BIANCO - WHITE	220 V	10 W	862	2700 K	140 €
PL10LBC/NE	NERO - BLACK	220 V	10 W	901	3000 K	140 €
PL10LBC/BI	BIANCO - WHITE	220 V	10 W	901	3000 K	140 €
PL10LBN/NE	NERO - BLACK	220 V	10 W	940	4000 K	140 €
PL10LBN/BI	BIANCO - WHITE	220 V	10 W	940	4000 K	140 €



Luce fredda 6000 K su richiesta  
6000 K cold light on request

### MAGGIORAZIONI CUSTOM



Lenti - € 8  
Lens

### CONO DI LUCE 36° 36° CONE OF LIGHT

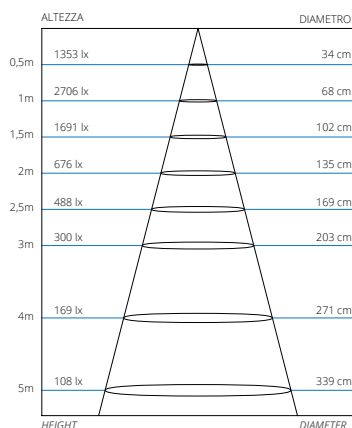

### CURVA FOTOMETRICA PHOTOMETRIC CURVE

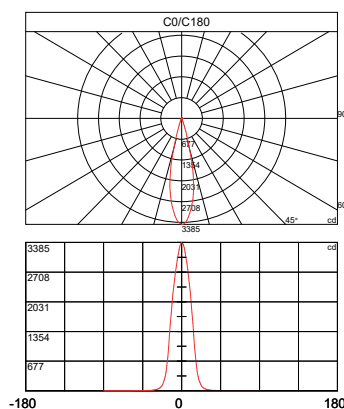

### FASCI D'APERTURA OPENING BEAMS

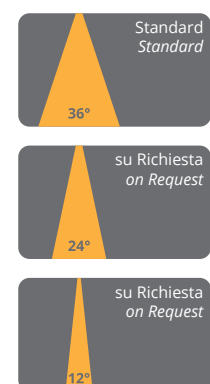

# SPOT 220V - 20W

## 220V SPOTLIGHT - 20W



L'utilizzo di Chip CRI95 garantisce un'elevata qualità della luce rendendo i colori vivaci e fedeli alla realtà.  
The CRI95 Chip LED guarantee a high quality of light and a perfect colour rendering.

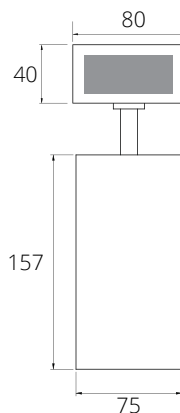

Alimentatore 220V integrato nella basetta  
220V power supply integrated in the base

- Corpo in pressofusione di alluminio verniciato a polveri
- Fascio d'apertura standard 36°
- LED durata utile: 50 000 (h) L90
- Apparecchio IP20
- Chip CRI95 e 3 Step MacAdam

- Body in die cast aluminum powder coated
- 36° standard beam angle lens
- LED life 50 000 (h) L90
- IP20 protection degree
- CRI95 and 3 Step MacAdam chip LED



CODICE CODE	COLORE COLOR	AC AC	CONSUMO POWER	LUMEN LUMEN	COLORE COLOR	LISTINO PRICE
PL20LBH/NE	NERO - BLACK	220 V	20 W	1960	2700 K	205 €
PL20LBH/BI	BIANCO - WHITE	220 V	20 W	1960	2700 K	205 €
PL20LBC/NE	NERO - BLACK	220 V	20 W	2010	3000 K	205 €
PL20LBC/BI	BIANCO - WHITE	220 V	20 W	2010	3000 K	205 €
PL20LBN/NE	NERO - BLACK	220 V	20 W	2058	4000 K	205 €
PL20LBN/BI	BIANCO - WHITE	220 V	20 W	2058	4000 K	205 €



Luce fredda 6000 K su richiesta  
6000 K cold light on request

### MAGGIORAZIONI CUSTOM



Lenti - € 8  
Lens

### CONO DI LUCE 36° 36° CONE OF LIGHT

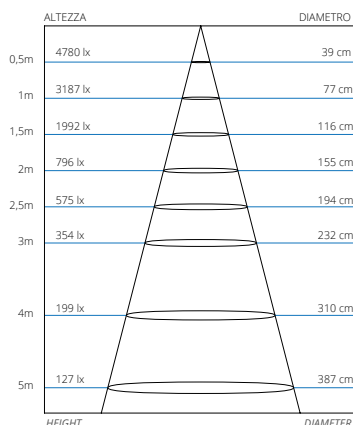

### CURVA FOTOMETRICA PHOTOMETRIC CURVE

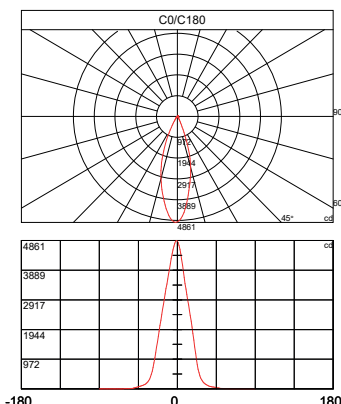

### FASCI D'APERTURA OPENING BEAMS





L'utilizzo di Chip CRI95 garantisce un'elevata qualità della luce rendendo i colori vivaci e fedeli alla realtà.  
The CRI95 Chip LED guarantees an high quality of light and a perfect colour rendering.

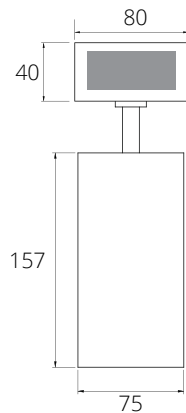

Alimentatore 220V integrato nella basetta  
220V power supply integrated in the base

## SPOT 220V - 30W 220V SPOTLIGHT - 30W



- Corpo in pressofusione di alluminio verniciato a polveri
- Fascio d'apertura standard 36°
- LED durata utile: 50 000 (h) L90
- Apparecchio IP20
- Chip CRI95 e 3 Step MacAdam

- Body in die cast aluminum powder coated
- 36° standard beam angle lens
- LED life 50 000 (h) L90
- IP20 protection degree
- CRI95 and 3 Step MacAdam chip LED



CODICE CODE	COLORE COLOR	AC AC	CONSUMO POWER	LUMEN LUMEN	COLORE COLOR	LISTINO PRICE
PL30LBH/NE	NERO - BLACK	220 V	30 W	2860	2700 K	220 €
PL30LBH/BI	BIANCO - WHITE	220 V	30 W	2860	2700 K	220 €
PL30LBC/NE	NERO - BLACK	220 V	30 W	2910	3000 K	220 €
PL30LBC/BI	BIANCO - WHITE	220 V	30 W	2910	3000 K	220 €
PL30LBN/NE	NERO - BLACK	220 V	30 W	2958	4000 K	220 €
PL30LBN/BI	BIANCO - WHITE	220 V	30 W	2958	4000 K	220 €



Luce fredda 6000 K su richiesta  
6000 K cold light on request

### MAGGIORAZIONI CUSTOM



Lenti - € 8  
Lens

### CONO DI LUCE 36° 36° CONE OF LIGHT

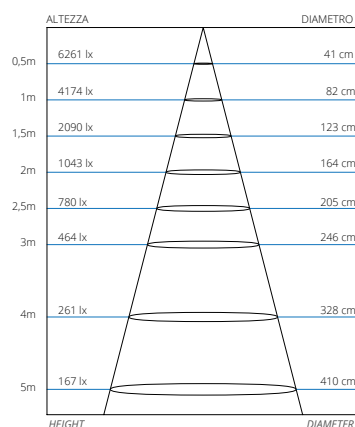

### CURVA FOTOMETRICA PHOTOMETRIC CURVE

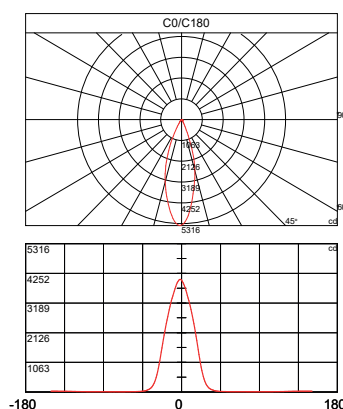

### FASCI D'APERTURA OPENING BEAMS

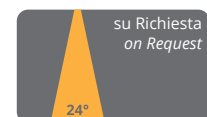
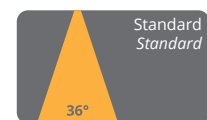



STRIP LED



# TABELLA COMPARAZIONE LUMEN STRIP LED

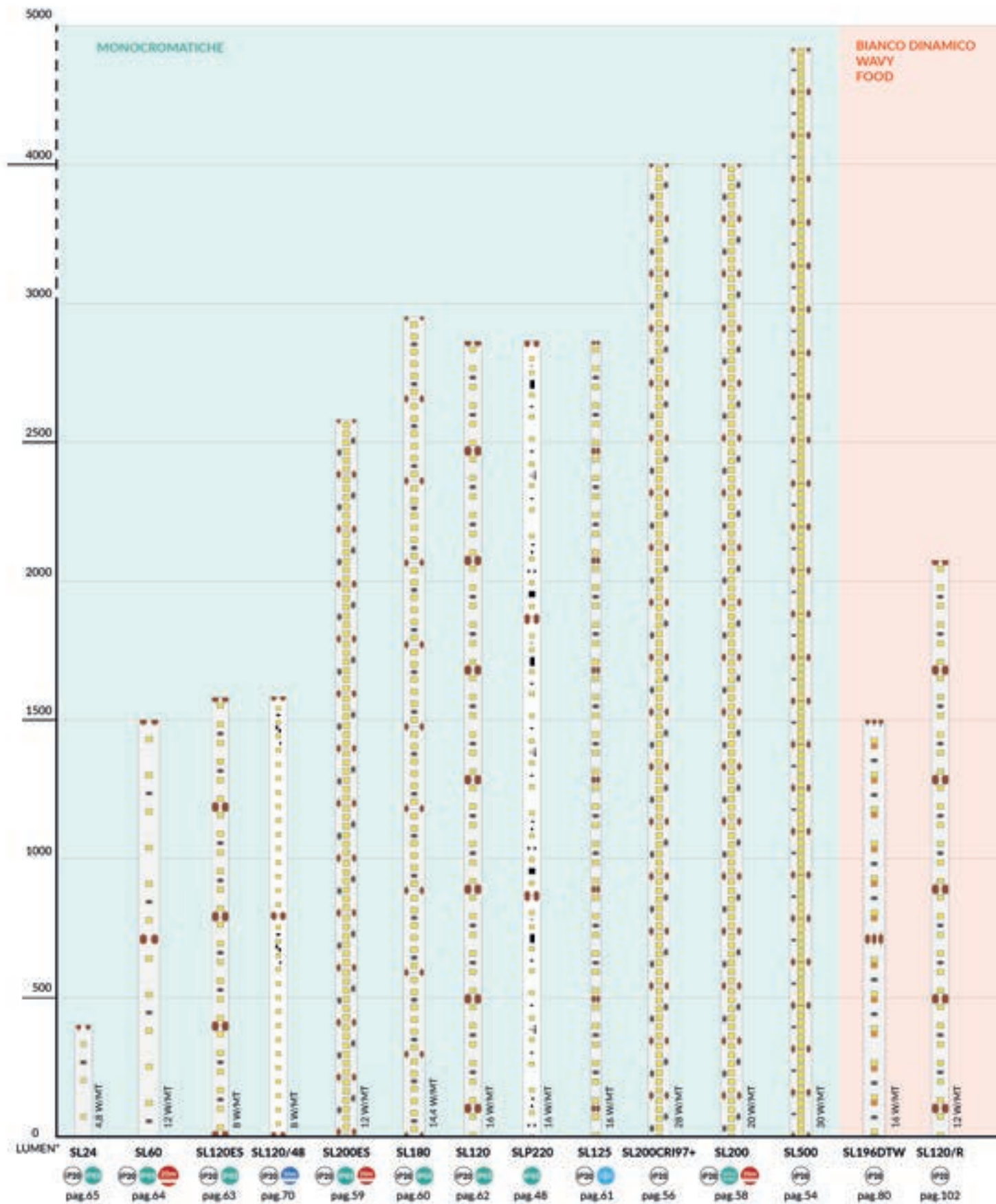

\*I lumen indicati si riferiscono ai valori nominali, l'utilizzo del prodotto con differenti profili e cover può incidere sul valore dei lumen reali in uscita.

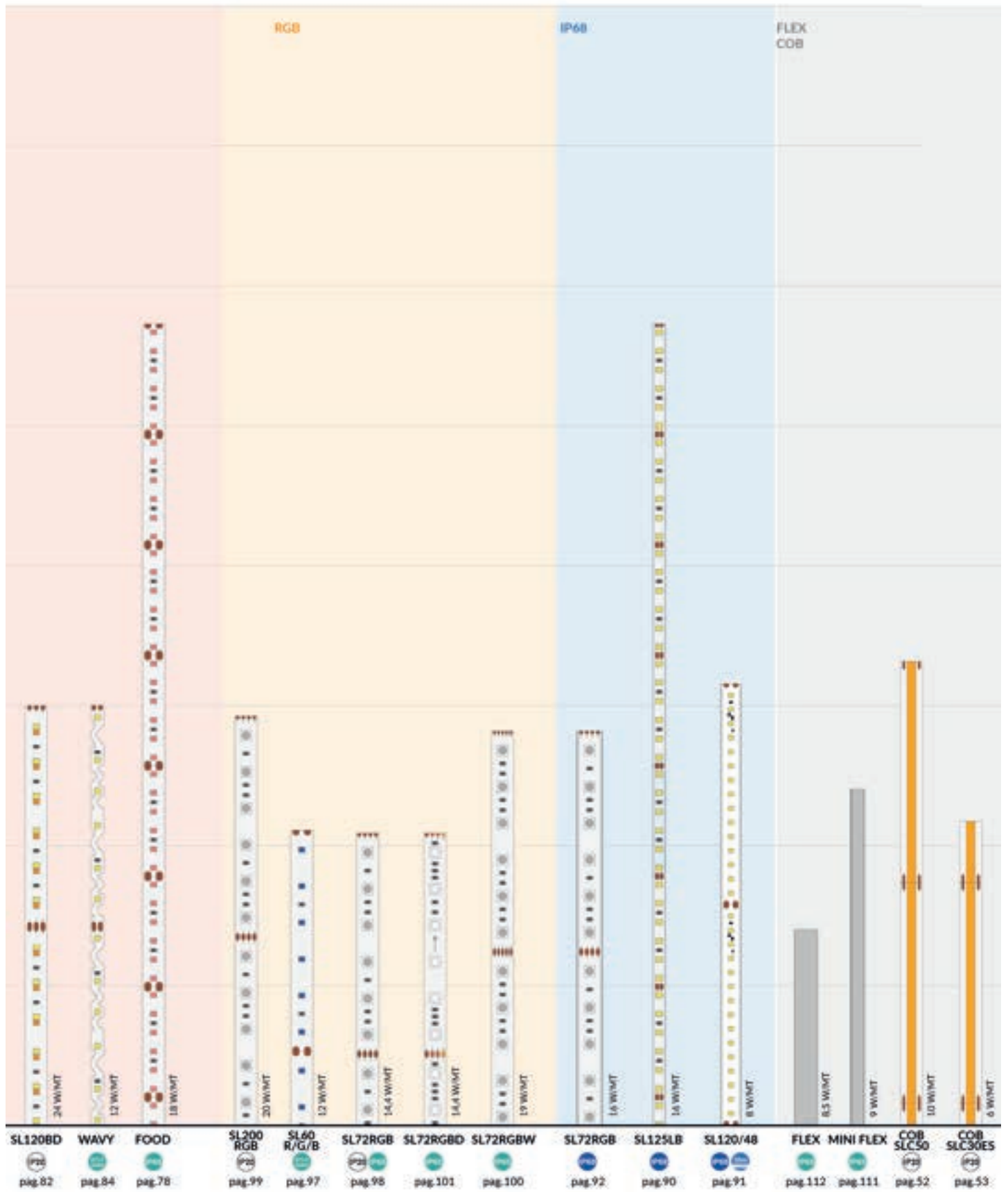

# STRIP LED 220V

La nuova strip LED con protezione attiva contro il cortocircuito.

Ora potrai sentirti al sicuro

*The new LED strip with active short-circuit protection.*

*Now on you can feel safe*



GUARDA  
COME  
FUNZIONA  
*see how it works*

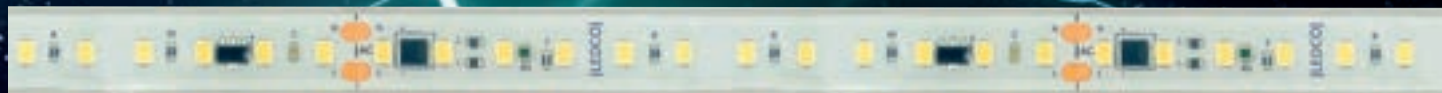

- Strip flessibile per illuminazione lineare con LED monocromatico, bobina da 5 metri, 10 metri, 20 metri, 50 metri
- Sezionabile ad interassi prefissati ogni 10 cm
- Protezione attiva contro corto circuito
- IP65 con estrusione di elastomero siliconico termo-dissipante all'interno
- Nastro adesivo VBH 3M sul retro
- Chip con CRI90+ e 3 Step MacAdam
- Collegabile alla rete senza il bisogno di un raddrizzatore supplementare
- Flexible strip for linear lighting with monochromatic LED. 5 meters, 10 meters, 20 meters, 50 meters reel
- Cuttable on fixed point every 10 cm
- Active protection against short circuit
- IP65 with thermo-dissipating silicone elastomer extrusion inside
- VBH 3M sticker tape on the strip back
- CRI90+ and 3 Step MacAdam chip LED
- Connectable to the mains without the need for an additional rectifier



**Fino a 50mt**  
con un punto di  
alimentazione

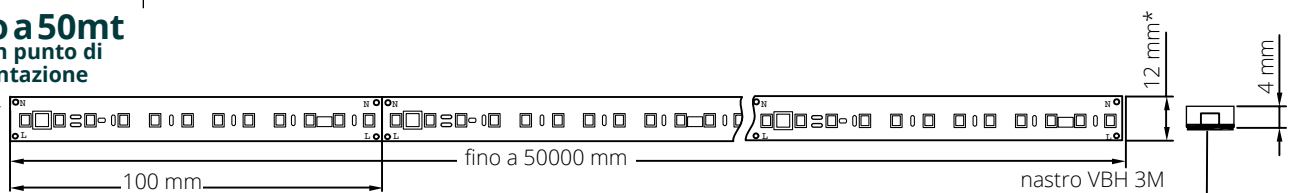

\*con l'aggiunta del tappo la larghezza sarà 13mm, lo spessore 5mm | \*with the addition of the cap the width will be 13mm, the thickness 5mm

5  
metri

10  
metri

20  
metri

50  
metri

CODICE	IP	LUNGHEZZA	CONSUMO	W/MT	COLORE	LED/MT	LUMEN/MT	AC	LISTINO
SLP220LBC65	65	5 metri	80 W	16 W	3000 K	120	2700	220 V	37 €/mt
SLP220LBN65	65	5 metri	80 W	16 W	4000 K	120	2740	220 V	37 €/mt
SLP220LBI65	65	5 metri	80 W	16 W	6000 K	120	2800	220 V	37 €/mt
SLP220LBC65/10	65	10 metri	160 W	16 W	3000 K	120	2700	220 V	37 €/mt
SLP220LBN65/10	65	10 metri	160 W	16 W	4000 K	120	2740	220 V	37 €/mt
SLP220LBI65/10	65	10 metri	160 W	16 W	6000 K	120	2800	220 V	37 €/mt
SLP220LBC65/20	65	20 metri	320 W	16 W	3000 K	120	2700	220 V	37 €/mt
SLP220LBN65/20	65	20 metri	320 W	16 W	4000 K	120	2740	220 V	37 €/mt
SLP220LBI65/20	65	20 metri	320 W	16 W	6000 K	120	2800	220 V	37 €/mt
SLP220LBC65/50	65	50 metri	800 W	16 W	3000 K	120	2700	220 V	37 €/mt
SLP220LBN65/50	65	50 metri	800 W	16 W	4000 K	120	2740	220 V	37 €/mt
SLP220LBI65/50	65	50 metri	800 W	16 W	6000 K	120	2800	220 V	37 €/mt

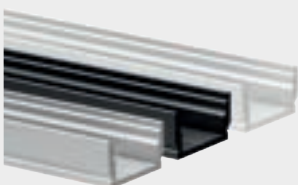
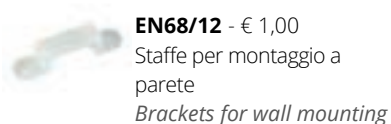
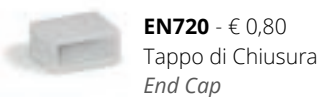

**Utilizza il profilo compatibile | Use the compatible profile**  
**PR115**

Profilo lineare 2mt / 3mt  
Aluminum profile 2mt / 3 mt

Per ulteriori dettagli vedi pag. 118 | For more details see page 118

Elimina l'effetto puntinato con il PR115 calpestabile. Vedi pag. 118  
Eliminate the dotted effect with walkable PR115. See page 118





LED CO®

**COB**  
CHIP LED



# STRIP LED COB

Con i suoi 576 chip led per ogni metro la tecnologia COB permette di ottenere un'illuminazione perfettamente omogenea anche su profili senza schermo o dove la strip è a vista.

*With its 576 LED chips per meter, the COB technology allows to obtain perfectly homogeneous lighting even on profiles without a screen or where the strip is visible.*

## STRIP LED COB SLC50



- Strip led flessibile per illuminazione lineare con LED monocromatico, bobina da 5 metri
- Sezionabile a interassi prefissati ogni 4,5 cm
- Nastro adesivo 3M sul retro 300LSE
- La doppia intestazione di cavi permette una connessione in serie più rapida
- L'elevata densità dei led (576 chip per metro) consente un'illuminazione omogenea su tutte le superfici
- Per la dissipazione termica è vivamente consigliato l'utilizzo di un profilo di alluminio di sezione adeguata
- The 5 meters flexible reel provides a linear monochromatic LED lighting
- Cuttable on fixed point every 4,5 cm
- 3M sticker tape on the strip back 300LSE
- Cables on both sides guarantee a faster in series connection
- High LED density (576 chip per meter) provides an uniform lightning on every surface
- An appropriate aluminum profile section is required for thermal dissipation

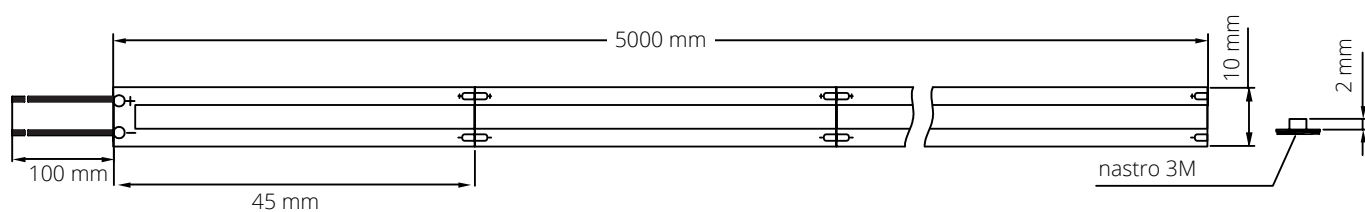

CODICE	IP	CONSUMO	W/MT	COLORE	LED/MT	LUMEN/MT	LUMEN	DC	LISTINO
SLC50LBC20	20	50 W	10 W	3000 K	576	1480	7400	24 V	120 €
SLC50LBN20	20	50 W	10 W	4000 K	576	1520	7600	24 V	120 €
SLC50LBI20	20	50 W	10 W	6000 K	576	1560	7800	24 V	120 €





# STRIP LED COB SLC30 ES



- Strip led flessibile per illuminazione lineare con LED monocromatico, bobina da 5 metri
- Sezionabile a interassi prefissati ogni 5 cm
- Nastro adesivo 3M sul retro 300LSE
- La doppia intestazione di cavi permette una connessione in serie più rapida
- L'elevata densità dei led (480 chip per metro) consente un'illuminazione omogenea su tutte le superfici
- La SLC30 Energy Saving differisce dalla versione normale per il numero di Lumen e il consumo di energia ridotto, mantenendo l'uniformità luminosa
- Per la dissipazione termica è vivamente consigliato l'utilizzo di un profilo di alluminio di sezione adeguata

- The 5 meters flexible reel provides a linear monochromatic LED lighting
- Cuttable on fixed point every 5 cm
- 3M sticker tape on the strip back 300LSE
- Cables on both sides guarantee a faster in series connection
- High LED density (480 chip per meter) provides an uniform lightning on every surface
- The SLC30 Energy Saving differs from the normal version in the number of Lumens and reduced energy consumption, while maintaining light uniformity
- An appropriate aluminum profile section is required for thermal dissipation

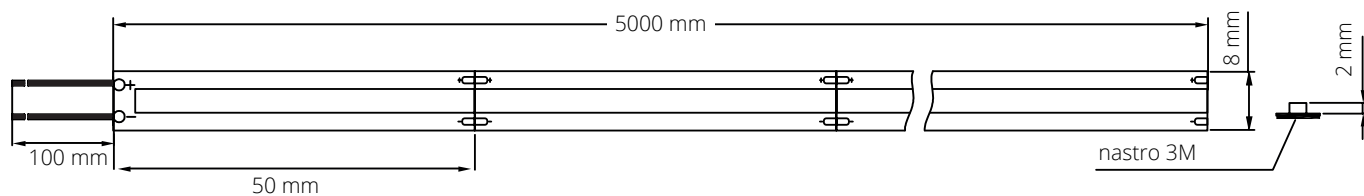

CODICE	IP	CONSUMO	W/MT	COLORE	LED/MT	LUMEN/MT	LUMEN	DC	LISTINO
SLC30LBH20	20	30 W	6 W	2700 K	480	936	4680	24 V	80 €
SLC30LBC20	20	30 W	6 W	3000 K	480	962	4810	24 V	80 €
SLC30LBN20	20	30 W	6 W	4000 K	480	988	4940	24 V	80 €
SLC30LBI20	20	30 W	6 W	6000 K	480	1014	5070	24 V	80 €





# SL500

Massima luminosità con la SL500.  
Illumina ambienti commerciali e  
professionali.

*Maximum brightness with the SL500.  
Illuminate commercial and  
professional environments.*



## STRIP LED SL500 - CHIP 2216



- Strip flessibile per illuminazione lineare con LED monocromatico, bobina da 5 metri
- Sezionabile ad interassi prefissati ogni 1,1 cm
- L'elevata densità dei led (528 chip per metro) consente un'illuminazione omogenea su tutte le superfici
- Nastro adesivo 3M sul retro
- La doppia intestazione dei cavi permette una connessione in serie più rapida
- Chip con CRI90+ e 3 Step MacAdam

- The 5 meters flexible reel provides a linear monochromatic LED lightning
- Cuttable on fixed point every 1,1 cm
- High LED density (528 chip per metro) provides an uniform lightning on every surface
- 3M sticker tape on the strip back
- Cables on both sides guarantee a faster in series connection
- CRI90+ and 3 Step MacAdam chip LED

● Elimina l'effetto puntinato con i profili! (vedi pag. 118)  
Eliminate the dotted effect with profiles! (see page 118)

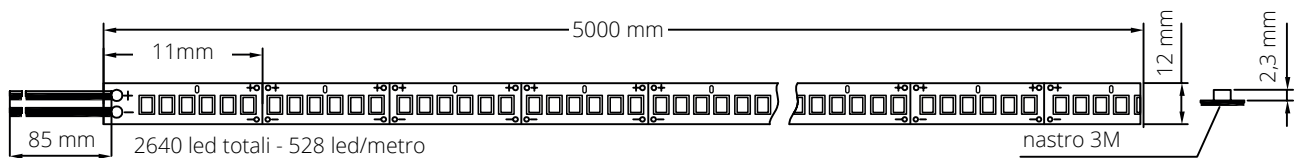

**2700K**

CODICE	IP	CONSUMO	W/MT	COLORE	LED/MT	LUMEN/MT	LUMEN	DC	LISTINO
SL500LBH20	20	150 W	30 W	2700 K	528	4730	23650	24 V	165 €
SL500LBC20	20	150 W	30 W	3000 K	528	4800	24000	24 V	165 €
SL500LBN20	20	150 W	30 W	4000 K	528	4910	24550	24 V	165 €
SL500LBI20	20	150 W	30 W	6000 K	528	4990	24950	24 V	165 €





## STRIP LED CRI 97+

La strip è ingegnerizzata con l'evoluto chip CRI 97+, che rende massima la fedeltà cromatica rispecchiando la realtà e la vivacità dei colori illuminati.

*The strip is engineered with the advanced CRI 97+ chip, which maximizes color fidelity by mirroring the reality and liveliness of the illuminated colors.*





- Strip led flessibile per illuminazione lineare con LED monocromatico, bobina da 5 metri
- Sezionabile ad interassi prefissati ogni 2,5 cm
- Nastro adesivo 3M sul retro 300LSE
- La doppia intestazione di cavi permette una connessione in serie più rapida
- L'elevata densità dei led (240 chip per metro) consente un'illuminazione omogenea su tutte le superfici
- Per la dissipazione termica è vivamente consigliato l'utilizzo di un profilo di alluminio di sezione adeguata
- 3 Step MacAdam
- The 5 meters flexible reel provides a linear monochromatic LED lighting
- Cuttable every 2,5 cm
- 3M sticker tape on the strip back 300LSE
- Cables on both sides guarantee a faster in series connection
- High LED density (240 chip per meter) provides an uniform lightning on every surface
- An appropriate aluminum profile section is required for thermal dissipation
- 3 Step MacAdam

• Elimina l'effetto puntinato con i profili! (vedi pag. 118)  
 • Eliminate the dotted effect with profiles! (see page 118)



L'utilizzo di chip con CRI 97+ garantisce un'elevata purezza della luce rendendo i colori vivaci e più fedeli alla realtà. *The CRI 97+ chip led guarantee an high purity of light and a perfect colour rendering.*

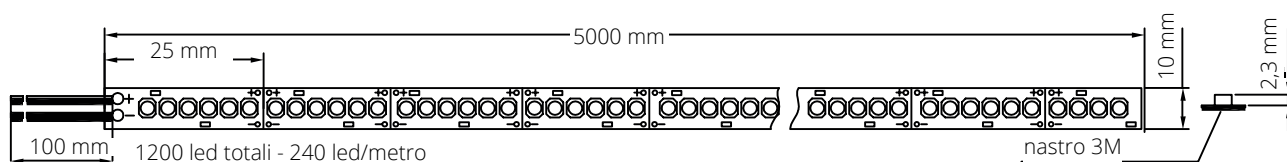

CODICE	IP	CONSUMO	W/MT	COLORE	LED/MT	LUMEN/MT	LUMEN	DC	LISTINO
SL200LBC20/97+	20	140 W	28	3000 K	240	3800	19000	24 V	125 €
SL200LBN20/97+	20	140 W	28	4000 K	240	3900	19500	24 V	125 €
SL200LBI20/97+	20	140 W	28	6000 K	240	4000	20000	24 V	125 €



# STRIP LED SL200 - CHIP 2835



- Strip led flessibile per illuminazione lineare con LED monocromatico, bobina da 5 metri
- Sezionabile ad interassi prefissati ogni 2,5 cm
- Le versioni IP54 sono completamente rivestite di nano particelle che le rendono impermeabili all'acqua
- Nastro adesivo 3M sul retro
- La doppia intestazione di cavi permette una connessione in serie più rapida
- L'elevata densità dei led (240 chip per metro) consente un'illuminazione omogenea su tutte le superfici
- Per la dissipazione termica è vivamente consigliato l'utilizzo di un profilo di alluminio di sezione adeguata
- Chip con CRI90+ e 3 Step MacAdam
- The 5 meters flexible reel provides a linear monochromatic LED lighting
- Cuttable every 2,5 cm
- The IP54 version uses the nano particles which make it waterproof
- 3M sticker tape on the strip back
- Cables on both sides guarantees a faster in series connection
- High LED density (240 chip per meter) provides an uniform lightning on every surface
- An appropriate aluminum profile section is required for thermal dissipation
- CRI90+ and 3 Step MacAdam chip LED

... Elimina l'effetto puntinato con i profili! ( vedi pag. 118)  
Eliminate the dotted effect with profiles! (see page 118)



L'utilizzo del rivestimento in nano particelle (conformal coating) non altera l'aspetto della strip, garantendo protezione all'acqua (IP54) e una migliore dissipazione termica.

The IP54 nano particles cover doesn't change the external aspect of the strip but it guarantees a waterproof effect and a better heat dissipation.

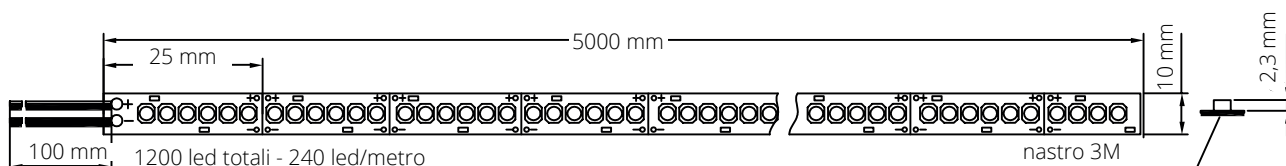

CODICE	IP	CONSUMO	W/MT	COLORE	LED/MT	LUMEN/MT	LUMEN	DC	LISTINO
SL200LBH20	20	100 W	20	2700 K	240	3360	16770	24 V	115 €
SL200LBC20	20	100 W	20	3000 K	240	3540	17700	24 V	115 €
SL200LBN20	20	100 W	20	4000 K	240	3635	18170	24 V	115 €
SL200LBI20	20	100 W	20	6000 K	240	3725	18620	24 V	115 €
SL200LBH65/N	54	100 W	20	2700 K	240	3360	16770	24 V	125 €
SL200LBC65/N	54	100 W	20	3000 K	240	3540	17700	24 V	125 €
SL200LBN65/N	54	100 W	20	4000 K	240	3635	18170	24 V	125 €
SL200LBI65/N	54	100 W	20	6000 K	240	3725	18620	24 V	125 €

**IP67**



Puoi trovare la versione IP67 a pag. 88  
You can find the IP67 version on page 88





# STRIP LED SL200 ES - CHIP 2835



- Strip led flessibile per illuminazione lineare con LED monocromatico, bobina da 5 metri
- Sezionabile ad interessi prefissati ogni 2,5 cm
- Nastro adesivo 3M 300LSE sul retro, alto potere adesivo anche su profili verniciati a polveri.
- La doppia intestazione di cavi permette una connessione in serie più rapida
- L'elevata densità dei led (240 chip per metro) consente un'illuminazione omogenea su tutte le superfici
- La SL200 Energy Saving differisce dalla versione normale per il numero di Lumen e il consumo di energia ridotto, mantenendo l'uniformità luminosa grazie ai 240 led al metro
- Chip con CRI90+ e 3 Step MacAdam
- The 5 meters flexible reel provides a linear monochromatic LED lighting
- Cuttable every 2,5 cm
- 3M 300LSE sticker tape guarantee a perfect adhesiveness also on powder painted profiles
- Cables on both sides guarantee a faster in series connection
- High LED density (240 chip per meter) provides an uniform lightning on every surface
- The SL200 Energy Saving differs from the normal version in the number of Lumens and reduced energy consumption, while maintaining light uniformity thanks to the 240 LEDs per meter
- CRI90+ and 3 Step MacAdam chip LED

••• Elimina l'effetto puntinato con i profili! (vedi pag. 118)  
Eliminate the dotted effect with profiles! (see page 118)



L'utilizzo del rivestimento in nano particelle (conformal coating) non altera l'aspetto della strip, garantendo protezione all'acqua (IP54) e una migliore dissipazione termica.

The IP54 nano particles cover doesn't change the external aspect of the strip but it guarantees a waterproof effect and a better heat dissipation.

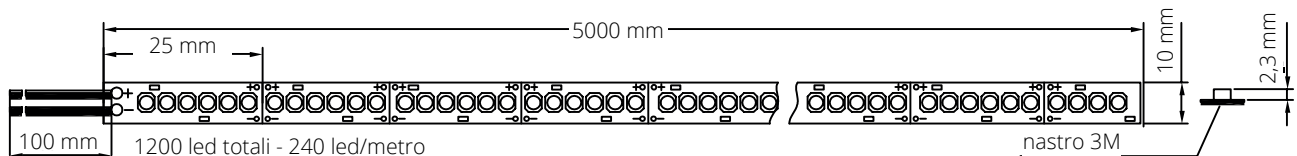

CODICE	IP	CONSUMO	W/MT	COLORE	LED/MT	LUMEN/MT	LUMEN	DC	LISTINO
SL200LBH20/ES	20	60 W	12	2700 K	240	2145	10720	24 V	105 €
SL200LBC20/ES	20	60 W	12	3000 K	240	2240	11190	24 V	105 €
SL200LBN20/ES	20	60 W	12	4000 K	240	2330	11640	24 V	105 €
SL200LBI20/ES	20	60 W	12	6000 K	240	2425	12120	24 V	105 €
SL200LBH65/ESN	54	60 W	12	2700 K	240	2145	10720	24 V	120 €
SL200LBC65/ESN	54	60 W	12	3000 K	240	2240	11190	24 V	120 €
SL200LBN65/ESN	54	60 W	12	4000 K	240	2330	11640	24 V	120 €
SL200LBI65/ESN	54	60 W	12	6000 K	240	2425	12120	24 V	120 €

**IP67**



Puoi trovare la versione IP67 a pag. 89  
You can find the IP67 version on page 89



# STRIP LED SL180 - CHIP 2835



- Strip led flessibile per illuminazione lineare con LED monocromatico, bobina da 5 metri
- Sezionabile ad interassi prefissati ogni 3,3 cm
- Nelle versioni IP65 utilizziamo un rivestimento protettivo in elastomero siliconico termo-dissipante con finitura diffondente (allunga la vita della strip all'esterno mantenendola trasparente e morbida nel tempo)
- Nastro adesivo 3M 300LSE sul retro, alto potere adesivo anche su profili verniciati a polveri.
- La doppia intestazione di cavi permette una connessione in serie più rapida
- L'elevata densità dei led (180 chip per metro) consente un'illuminazione omogenea su tutte le superfici
- Per la dissipazione termica è vivamente consigliato l'utilizzo di un profilo di alluminio di sezione adeguata
- Chip con CRI90+ e 3 Step MacAdam
- The 5 meters flexible reel provides a linear monochromatic LED lightning
- Cuttable every 3,3 cm
- The IP65 version uses a silicon thermal-dissipating protective coating
- 3M 300LSE sticker tape guarantee a perfect adhesiveness also on powder painted profiles
- Cables on both sides guarantee a faster in series connection
- High LED density (180 chip per meter) provides a uniform lightning on every surface
- An appropriate aluminum profile section is required for thermal dissipation
- CRI90+ and 3 Step MacAdam chip LED

Elimina l'effetto puntinato con i profili! ( vedi pag. 118)  
Eliminate the dotted effect with profiles! (see page 118)

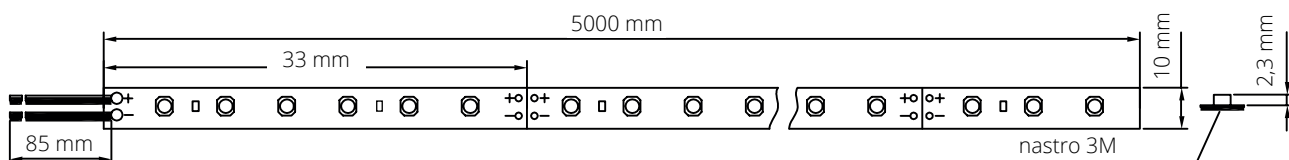

CODICE	IP	CONSUMO	W/MT	COLORE	LED/MT	LUMEN/MT	LUMEN	DC	LISTINO
SL180LBH20	20	72 W	14,4 W	2700 K	180	2550	12750	24 V	100 €
SL180LBC20	20	72 W	14,4 W	3000 K	180	2680	13400	24 V	100 €
SL180LBN20	20	72 W	14,4 W	4000 K	180	2720	13600	24 V	100 €
SL180LBI20	20	72 W	14,4 W	6000 K	180	2790	13950	24 V	100 €
SL180LBH65	65	72 W	14,4 W	2700K	180	2550	12750	24 V	105 €
SL180LBC65	65	72 W	14,4 W	3000 K	180	2680	13400	24 V	105 €
SL180LBN65	65	72 W	14,4 W	4000 K	180	2720	13600	24 V	105 €
SL180LBI65	65	72 W	14,4 W	6000 K	180	2790	13950	24 V	105 €





# STRIP LED 5mm SL125 - CHIP 2835



- Strip led flessibile per illuminazione lineare con LED monocromatico, bobina da 5 metri
- Sezionabile ad interassi prefissati ogni 5 cm
- Nastro adesivo 3M 300LSE sul retro, alto potere adesivo anche su profili verniciati a polveri
- La doppia intestazione di cavi permette una connessione in serie più rapida
- La pista flessibile miniaturizzata a soli 5mm permette l'installazione anche in spazi molto piccoli

- The 5 meters flexible reel provides a linear monochromatic LED lightning
- Cuttable every 5 cm
- 3M 300LSE sticker tape guarantee a perfect adhesiveness also on powder painted profiles
- Cables on both sides guarantee a faster in series connection
- The 5mm flexible PCB provide the best solution for small spaces

••• Elimina l'effetto puntinato con i profili! ( vedi pag. 118)  
 Eliminate the dotted effect with profiles! (see page 118)

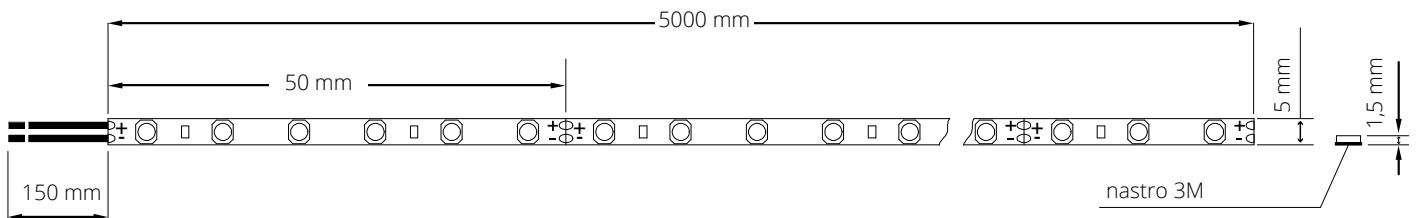

CODICE	IP	CONSUMO	W/MT	COLORE	LED/MT	LUMEN/MT	LUMEN	DC	LISTINO
SL125LBC20	20	80 W	16	3000 K	120	2700	13500	24 V	95 €
SL125LBN20	20	80 W	16	4000 K	120	2740	13700	24 V	95 €
SL125LBI20	20	80 W	16	6000 K	120	2800	14000	24 V	95 €

**IP68** Puoi trovare la versione IP68 a pag. 90  
 You can find the IP68 version on page 90



# STRIP LED SL120 - CHIP 2835



- Strip flessibile per illuminazione lineare con LED monocromatico, bobina da 5 metri
  - Sezionabile ad interassi prefissati ogni 5 cm
  - Nelle versioni IP65 utilizziamo un rivestimento protettivo in elastomero silconico termo-dissipante con finitura diffondente (allunga la vita della strip all'esterno mantenendola trasparente e morbida nel tempo)
  - Nastro adesivo 3M sul retro
  - La doppia intestazione dei cavi permette una connessione in serie più rapida
  - Chip con CRI90+ e 3 Step MacAdam
  - The 5 meters flexible reel provides a linear monochromatic LED lightning
  - Cuttable on fixed point every 5 cm
  - The IP65 version uses an silicon thermal-dissipating protective coating (extends the life of the strip on the outside, keeping it transparent and soft over time)
  - 3M sticker tape on the strip back.
  - Cables on both sides guarantee a faster in series connection
  - CRI90+ and 3 Step MacAdam chip LED
- Elimina l'effetto puntinato con i profili! ( vedi pag. 118)  
Eliminate the dotted effect with profiles! (see page 118)

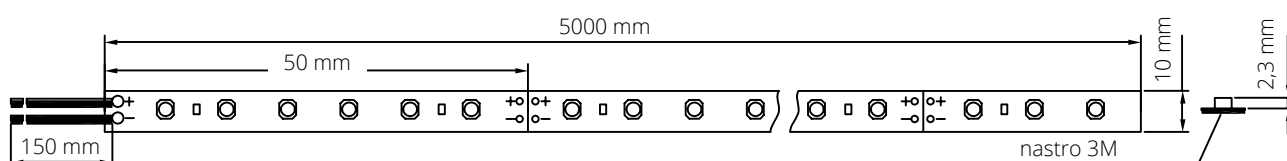

CODICE	IP	CONSUMO	W/MT	COLORE	LED/MT	LUMEN/MT	LUMEN	DC	LISTINO
SL120LBH20	20	80 W	16	2700 K	120	2490	12450	24 V	95 €
SL120LBC20	20	80 W	16	3000 K	120	2650	13250	24 V	95 €
SL120LBN20	20	80 W	16	4000 K	120	2685	13425	24 V	95 €
SL120LBI20	20	80 W	16	6000 K	120	2745	13725	24 V	95 €
SL120LBH65	65	80 W	16	2700 K	120	2490	12450	24 V	100 €
SL120LBC65	65	80 W	16	3000 K	120	2650	13250	24 V	100 €
SL120LBN65	65	80 W	16	4000 K	120	2685	13425	24 V	100 €
SL120LBI65	65	80 W	16	6000 K	120	2745	13725	24 V	100 €





- Strip flessibile per illuminazione lineare con LED monocromatico, bobina da 5 metri
  - Sezionabile ad interassi prefissati 5 cm
  - Nelle versioni IP65 utilizziamo un rivestimento protettivo in elastomero siliconico termo-dissipante con finitura diffondente (allunga la vita della strip all'esterno mantenendola trasparente e morbida nel tempo)
  - Nastro adesivo 3M sul retro
  - La doppia intestazione dei cavi permette una connessione in serie più rapida
  - La SL120 Energy Saving differisce dalla versione normale per il numero di Lumen e il consumo di energia ridotto, mantenendo l'uniformità luminosa grazie ai 120 led al metro
  - Chip con CRI90+ e 3 Step MacAdam
  - The 5 meters flexible reel provides a linear monochromatic LED lightning
  - Cuttable on fixed point 5 cm
  - The IP65 version uses an silicon thermal-dissipating protective coating (extends the life of the strip on the outside, keeping it transparent and soft over time)
  - 3M sticker tape on the strip back.
  - Cables on both sides guarantee a faster in series connection
  - The SL120 Energy Saving differs from the normal version in the number of Lumens and reduced energy consumption, while maintaining light uniformity thanks to the 120 LEDs per meter
  - CRI90+ and 3 Step MacAdam chip LED
- Elimina l'effetto puntinato con i profili! (vedi pag. 118)  
Eliminate the dotted effect with profiles! (see page 118)



Il chip utilizzato è il 2835 di 4° generazione, garantisce prestazioni del 30% superiori rispetto ai tradizionali chip 5050 abbassando i consumi del 40%. Il risparmio energetico rispetto a una strip da 72W è di circa il 50%

The LED chip used is the 2835. It is a 4th generation chip led which guarantees a 30% more of better performances instead of the traditional 5050 model, reducing the consumption of 40%. The total energy saving is approximately of the 50%.

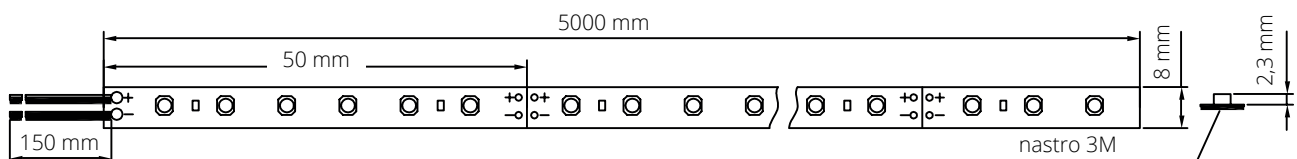

CODICE	IP	CONSUMO	W/MT	COLORE	LED/MT	LUMEN/MT	LUMEN	DC	LISTINO
SL120LBH20/ES	20	40 W	8 W	2700 K	120	1375	6875	24 V	85 €
SL120LBC20/ES	20	40 W	8 W	3000 K	120	1450	7250	24 V	85 €
SL120LBN20/ES	20	40 W	8 W	4000 K	120	1490	7450	24 V	85 €
SL120LBI20/ES	20	40 W	8 W	6000 K	120	1530	7650	24 V	85 €
SL120LBH65/ES	65	40 W	8 W	2700 K	120	1375	6875	24 V	90 €
SL120LBC65/ES	65	40 W	8 W	3000 K	120	1450	7250	24 V	90 €
SL120LBN65/ES	65	40 W	8 W	4000 K	120	1490	7450	24 V	90 €
SL120LBI65/ES	65	40 W	8 W	6000 K	120	1530	7650	24 V	90 €



# STRIP LED SL60 - CHIP 2835



- Strip flessibile per illuminazione lineare con LED monocromatico, bobina da 5 metri
- Sezionabile ad interassi prefissati ogni 10 cm
- Nelle versioni IP65 utilizziamo un rivestimento protettivo in elastomero siliconico termo-dissipante con finitura diffondente (allunga la vita della strip all'esterno mantenendola trasparente e morbida nel tempo)
- Nastro adesivo 3M sul retro
- La doppia intestazione dei cavi permette una connessione in serie più rapida
- Chip con CRI90+ e 3 Step MacAdam
- The 5 meters flexible reel provides a linear monochromatic LED lightning
- Cuttable on fixed point every 10 cm
- The IP65 version uses an silicon thermal-dissipating protective coating (extends the life of the strip on the outside, keeping it transparent and soft over time)
- 3M sticker tape on the strip back.
- Cables on both sides guarantee a faster in series connection
- CRI90+ and 3 Step MacAdam chip LED

... Elimina l'effetto puntinato con i profili! (vedi pag. 118)  
Eliminate the dotted effect with profiles! (see page 118)

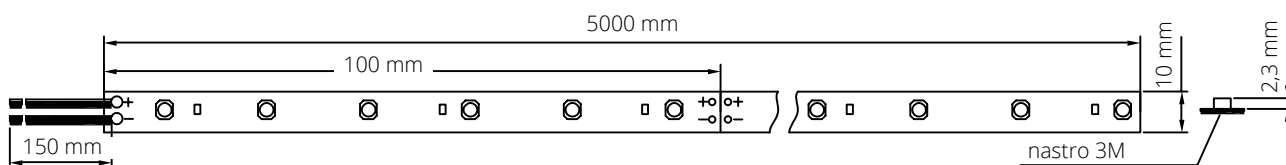

CODICE	IP	CONSUMO	W/MT	COLORE	LED/MT	LUMEN/MT	LUMEN	DC	LISTINO
SL60LBC20	20	60 W	12 W	3000 K	60	1390	6950	24 V	75 €
SL60LBN20	20	60 W	12 W	4000 K	60	1430	7150	24 V	75 €
SL60LBI20	20	60 W	12 W	6000 K	60	1470	7350	24 V	75 €
SL60LBC65	65	60 W	12 W	3000 K	60	1390	6950	24 V	80 €
SL60LBN65	65	60 W	12 W	4000 K	60	1430	7150	24 V	80 €
SL60LBI65	65	60 W	12 W	6000 K	60	1470	7350	24 V	80 €
SL60LBC20/12	20	60 W	12 W	3000 K	60	1390	6950	12 V	75 €
SL60LBN20/12	20	60 W	12 W	4000 K	60	1430	7150	12 V	75 €
SL60LBI20/12	20	60 W	12 W	6000 K	60	1470	7350	12 V	75 €
SL60LBC65/12	65	60 W	12 W	3000 K	60	1390	6950	12 V	80 €
SL60LBN65/12	65	60 W	12 W	4000 K	60	1430	7150	12 V	80 €
SL60LBI65/12	65	60 W	12 W	6000 K	60	1470	7350	12 V	80 €







# STRIP LED SL24 - CHIP 3528



- Strip flessibile per illuminazione lineare con LED monocromatico, bobina da 5 metri
- Sezionabile ad interassi prefissati ogni 10 cm
- Nelle versioni IP65 utilizziamo un rivestimento protettivo in elastomero siliconico termo-dissipante con finitura diffondente (allunga la vita della strip all'esterno mantenendola trasparente e morbida nel tempo)
- Nastro adesivo 3M sul retro
- La doppia intestazione dei cavi permette una connessione in serie più rapida
- The 5 meters flexible reel provides a linear monochromatic LED lightning
- Cuttable on fixed point every 10 cm
- The IP65 version uses an silicon thermal-dissipating protective coating (extends the life of the strip on the outside, keeping it transparent and soft over time)
- 3M sticker tape on the strip back.
- Cables on both sides guarantee a faster in series connection

••• Elimina l'effetto puntinato con i profili! ( vedi pag. 118)  
 Eliminate the dotted effect with profiles! (see page 118)

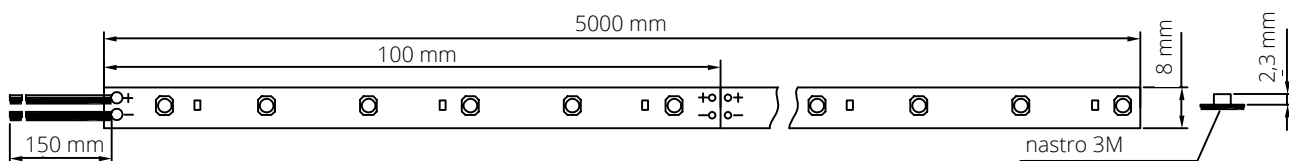

CODICE	IP	CONSUMO	W/MT	COLORE	LED/MT	LUMEN/MT	LUMEN	DC	LISTINO
SL24LBC20	20	24 W	4,8 W	3000 K	60	320	1600	24 V	42,50 €
SL24LBN20	20	24 W	4,8 W	4000 K	60	340	1700	24 V	42,50 €
SL24LBI20	20	24 W	4,8 W	6000 K	60	360	1800	24 V	42,50 €
SL24LBC65	65	24 W	4,8 W	3000 K	60	320	1600	24 V	47,50 €
SL24LBN65	65	24 W	4,8 W	4000 K	60	340	1700	24 V	47,50 €
SL24LBI65	65	24 W	4,8 W	6000 K	60	360	1800	24 V	47,50 €





STRIP LED  
**20**  
METRI



# STRIP LED SL60 - CHIP 2835

## 20 metri



- Strip flessibile per illuminazione lineare con LED monocromatico, bobina da 20 metri
- Sezionabile ad interassi prefissati ogni 10 cm
- Nastro adesivo 3M 300LSE sul retro, alto potere adesivo anche su profili verniciati a polveri.
- La doppia intestazione dei cavi permette una connessione in serie più rapida
- Chip con CRI90+ e 3 Step MacAdam

- The 20 meters flexible reel provides a linear monochromatic LED lightning
- Cuttable on fixed point every 10 cm
- 3M 300LSE sticker tape guarantee a perfect adhesiveness also on powder painted profiles
- Cables on both sides guarantee a faster in series connection
- CRI90+ and 3 Step MacAdam chip LED

••• Elimina l'effetto puntinato con i profili! ( vedi pag. 118)  
 Eliminate the dotted effect with profiles! (see page 118)

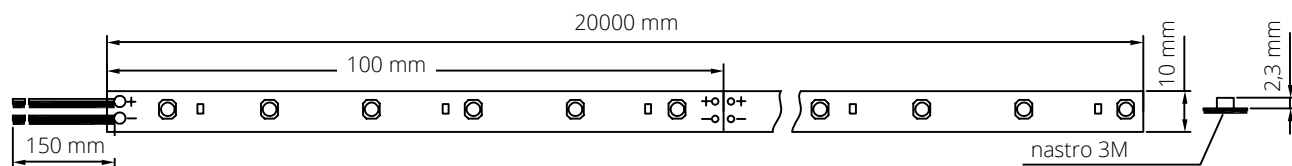

CODICE	IP	W/MT	COLORE	LED/MT	LUMEN/MT	DC	LISTINO
SL60LBC20/20	20	12 W	3000 K	60	1390	24 V	345 €
SL60LBN20/20	20	12 W	4000 K	60	1430	24 V	345 €
SL60LBI20/20	20	12 W	6000 K	60	1470	24 V	345 €

\*per la connessione si consiglia l'alimentazione da entrambi i lati così da evitare cadute di tensione

\*for the connection we recommend the power supply from both sides in order to avoid voltage drops



# STRIP LED SL200 - CHIP 2835



- Strip led flessibile per illuminazione lineare con LED monocromatico, bobina da 20 metri
  - Sezionabile ad interassi prefissati ogni 2,5 cm
  - Nastro adesivo 3M 300LSE sul retro, alto potere adesivo anche su profili verniciati a polveri.
  - La doppia intestazione di cavi permette una connessione in serie più rapida
  - L'elevata densità dei led (240 chip per metro) consente un illuminazione omogenea su tutte le superfici
  - Per la dissipazione termica è vivamente consigliato l'utilizzo di un profilo di alluminio di sezione adeguata
  - Chip con CRI90+ e 3 Step MacAdam
  - The 20 meters flexible reel provides a linear monochromatic LED lightning
  - Cuttable every 2,5 cm
  - 3M 300LSE sticker tape guarantee a perfect adhesiveness also on powder painted profiles
  - Cables on both sides guarantee a faster in series connection
  - High LED density (240 chip per meter) provides an uniform lightning on every surface
  - An appropriate aluminum profile section is required for thermal dissipation
  - CRI90+ and 3 Step MacAdam chip LED
- Elimina l'effetto puntinato con i profili! ( vedi pag. 118)  
Eliminate the dotted effect with profiles! (see page 118)

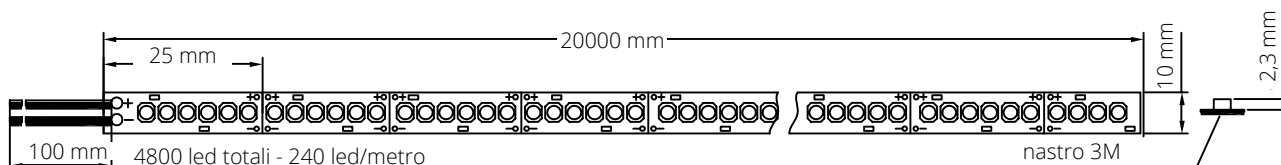

CODICE	IP	W/MT	COLORE	LED/MT	LUMEN/MT	DC	LISTINO
SL200LBC20/20	20	20	3000 K	240	3540	24 V	465 €
SL200LBN20/20	20	20	4000 K	240	3640	24 V	465 €
SL200LBI20/20	20	20	6000 K	240	3725	24 V	465 €

\*per la connessione si consiglia l'alimentazione da entrambi i lati così da evitare cadute di tensione  
\*for the connection we recommend the power supply from both sides in order to avoid voltage drops





# STRIP LED SL200 ES - CHIP 2835

## 20 metri



- Strip led flessibile per illuminazione lineare con LED monocromatico, bobina da 20 metri
- Sezionabile ad interassi prefissati ogni 2,5 cm
- Nastro adesivo 3M 300LSE sul retro, alto potere adesivo anche su profili verniciati a polveri.
- La doppia intestazione di cavi permette una connessione in serie più rapida
- L'elevata densità dei led (240 chip per metro) consente un'illuminazione omogenea su tutte le superfici
- La SL200 Energy Saving differisce dalla versione normale per il numero di Lumen e il consumo di energia ridotto, mantenendo l'uniformità luminosa grazie ai 240 led al metro
- Chip con CRI90+ e 3 Step MacAdam
- The 20 meters flexible reel provides a linear monochromatic LED lightning
- Cuttable every 2,5 cm
- 3M 300LSE sticker tape guarantee a perfect adhesiveness also on powder painted profiles
- Cables on both sides guarantee a faster in series connection
- High LED density (240 chip per meter) provides an uniform lightning on every surface
- The SL200 Energy Saving differs from the normal version in the number of Lumens and reduced energy consumption, while maintaining light uniformity thanks to the 240 LEDs per meter
- CRI90+ and 3 Step MacAdam chip LED

... Elimina l'effetto puntinato con i profili! ( vedi pag. 118)  
 Eliminate the dotted effect with profiles! (see page 118)

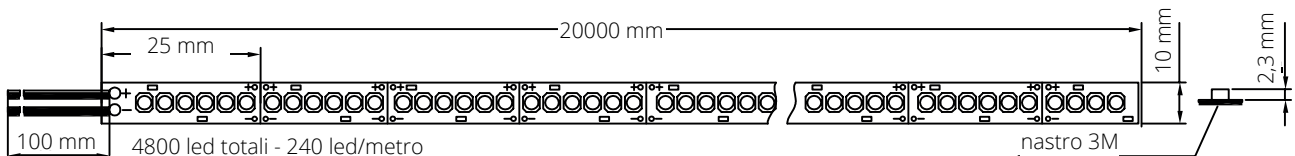

## 20 metri

CODICE	IP	W/MT	COLORE	LED/MT	LUMEN/MT	DC	LISTINO
SL200LBC20/20ES	20	12	3000 K	240	2240	24 V	445 €
SL200LBN20/20ES	20	12	4000 K	240	2330	24 V	445 €
SL200LBI20/20ES	20	12	6000 K	240	2425	24 V	445 €

\*per la connessione si consiglia l'alimentazione da entrambi i lati così da evitare cadute di tensione  
 \*for the connection we recommend the power supply from both sides in order to avoid voltage drops



# STRIP LED

# 30 MT 48 VOLT

Con un unico punto di alimentazione 30 metri di luce senza caduta di tensione.

I circuiti integrati con alimentazione a 48volt rilanciano la corrente su tutta la lunghezza della strip.

*With a single power point 30 meters of light without voltage drop.*

*The integrated circuits with 48 volt power supply boost the current over the entire length of the strip.*





# STRIP LED 48V - CHIP 2835



## 30 metri



- Strip led flessibile per illuminazione lineare con LED monocromatico, bobina da 30 metri
- Sezionabile ad interassi prefissati ogni 12,5 cm
- Nastro adesivo 3M 300LSE sul retro, alto potere adesivo anche su profili verniciati a polveri.
- La doppia intestazione di cavi permette una connessione in serie più rapida
- I circuiti integrati a bordo della strip rilanciano la corrente, permettendo di raggiungere 30 metri con un solo punto di alimentazione
- Chip con CRI90+ e 3 Step MacAdam
- The 30 meters flexible reel provides a linear monochromatic LED lightning
- Cuttable every 12,5 cm
- 3M 300LSE sticker tape guarantee a perfect adhesiveness also on powder painted profiles
- Cables on both sides guarantee a faster in series connection
- Integrated Circuit on board allow to power on 30 meter of strip led without voltage drop
- CRI90+ and 3 Step MacAdam chip LED

☺ Elimina l'effetto puntinato con i profili! ( vedi pag. 118)  
 Eliminate the dotted effect with profiles! (see page 118)

Disponibile in lunghezze customizzate fino ad un massimo di 30 metri.  
 Available in customized lengths up to a maximum of 30 meters.

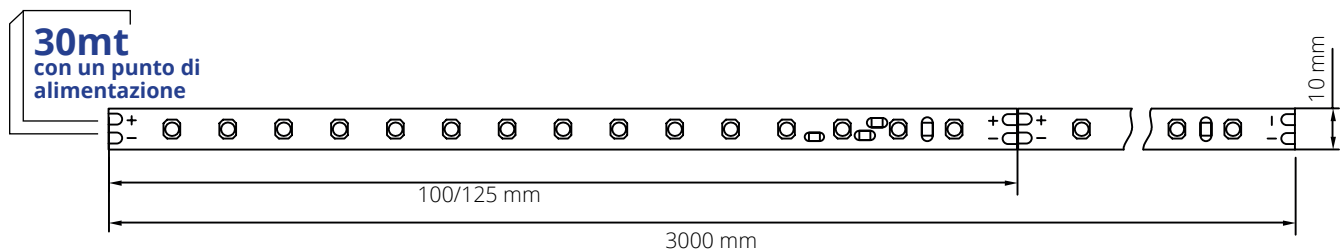

CODICE	IP	W/MT	COLORE	LED/MT	LUMEN/MT	DC	LISTINO
SL120LBC20/48	20	8 W	3000 K	120	1410	48 V	22 €/mt
SL120LBN20/48	20	8 W	4000 K	120	1450	48 V	22 €/mt
SL120LBI20/48	20	8 W	6000 K	120	1490	48 V	22 €/mt

**IP68** Puoi trovare la versione IP68 a pag. 91  
 You can find the IP68 version on page 91

# LED UVC GERMICIDI

per sanificare ambienti e superfici

## *GERMICIDAL UVC LED*

*to sanitize environments and surfaces*





# STRIP LED E BARRE LED UVC PER SANIFICARE AMBIENTI E SUPERFICI

I prodotti a raggi UVC Ledco, utilizzano la radiazione ultravioletta germicida (UVGI), questo è un metodo di sterilizzazione e disinfezione che sfrutta la luce ultravioletta UVC con lunghezze d'onda comprese nella banda tra 280 e 100 nanometri, garantendo la totale efficacia germicida e sterilizzante.

Strip LED e Barre LED UVC sono adatte alla sanificazione di ogni ambiente e superficie, la potenza dei raggi UVC sterilizza da ogni tipo di micro-organismo, come batteri, virus, spore e protozoi, causa di diverse malattie nell'uomo e negli animali, compreso il COVID-19.

È possibile utilizzare i prodotti a raggi UVC **quando gli ambienti sono vuoti, in assenza di persone o animali**, immaginiamo all'uscita dall'ufficio, dal negozio o da una stanza della propria abitazione, spegneremo le normali luci per accendere i LED UVC ad azione germicida.

È possibile scegliere dei LED UVC che agiscono su una specifica area circoscritta, pensiamo ad una scrivania o ad un banco di lavoro, oppure utilizzare LED più grandi che agiscono su uno spazio ampio, come un'intera stanza.

Diverse centinaia di batteri e virus testati fino ad oggi rispondono alla disinfezione dei raggi UVC. La luce UVC uccide oltre i Coronavirus almeno altri due parenti prossimi del COVID-19: il SARSCoV-1 (causa della SARS) e il MERS-CoV (causa della Sindrome Respiratoria medio-orientale).

## UVC LED STRIP AND LED BARS TO SANITIZE ENVIRONMENTS AND SURFACES

*Ledco UVC products, use germicidal ultraviolet radiation (UVGI), this is a sterilization and disinfection method that uses UVC ultraviolet light with wavelengths in the band between 280 and 100 nanometers, ensuring total germicidal efficacy and sterilizing.*

*UVC LED Strip and LED bars are suitable for sanitizing any environment and surface, the power of UVC rays sterilizes from all types of micro-organisms, such as bacteria, viruses, spores and protozoa, the cause of various diseases in humans and animals, including COVID-19.*

*It is possible to use the UVC products **when the rooms are empty, without the presence of people or animals**, imagine when leaving the office or shop, we will turn off the normal lights to turn on the germicidal UVC LED.*

*You can choose UVC LED that act on a specific circumscribed area, think of a desk or work bench, or use larger LED that act on a large space, such as an entire room.*

*Several hundred bacteria and viruses tested to date respond to disinfection of UVC rays. UVC light kills at least two other relatives besides coronaviruses next of COVID-19: SARSCoV-1 (cause of SARS)*

## STRIP LED UVC



Strip led UVC ad azione germicida totale, per la sanificazione e disinfezione di superfici ed ambienti.

La potenza germicida dei raggi UVC agisce in 20 minuti a distanza di 1 metro dalla superficie che vogliamo igienizzare, eliminando ogni tipo di micro-organismo, virus e batterio, compreso il COVID-19.

**IMPORTANTE: non utilizzare la strip led UVC in presenza di persone o animali, la potente azione germicida dei led UVC non consente la presenza di alcun essere vivente durante l'irradiazione della luce.**

*UVC led strip with total germicidal action, for the sanitization and disinfection of surfaces and environments.*

*The germicidal power of UVC rays acts in 20 minutes at a distance of 1 meter from the surface we want to sanitize, eliminating all types of micro-organisms, viruses and bacteria, including COVID-19.*

***IMPORTANT: do not use the UVC LED strip in the presence of people or animals, the powerful germicidal action of the UVC LEDs does not allow the presence of any living being during the irradiation of light.***

- Strip led flessibile per la sanificazione di superfici e ambienti, bobina da 5 metri;
  - Sezionabile ad interassi prefissati ogni 8,4 cm;
  - Nastro adesivo 3M sul retro;
  - La doppia intestazione di cavi permette una connessione in serie più rapida.
  - Per la dissipazione termica è vivamente consigliato l'utilizzo di un profilo di alluminio di sezione adeguata.
- Flexible led strip for sanitizing surfaces and environments, 5 meter reel;
  - Can be sectioned at fixed distances every 8.4 cm;
  - 3M adhesive tape on the back;
  - The double header of cables allows a faster series connection.
  - For heat dissipation, the use of an aluminum profile with an adequate section is strongly recommended.

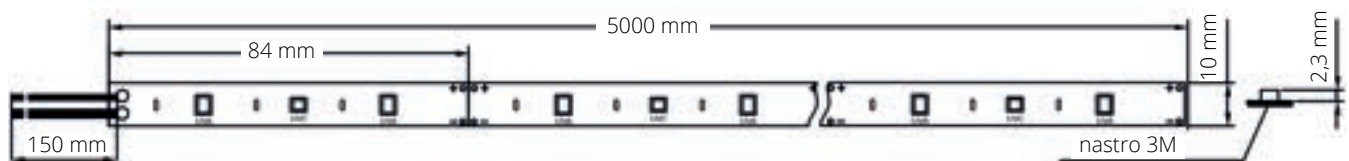

CODICE	DESCRIZIONE	IP	CONSUMO	W/MT	LED/MT	DC	LISTINO
SL36UVC20	STRIP LED UVC	20	85 W	17	12 UVC + 24 UVA	24 V	600 €





Strip led UVA per una sanificazione di superfici e ambienti più blanda, richiede maggior tempo per una azione igienizzante, è possibile utilizzarla in presenza di persone o animali.

*UVA led strip for a milder sanitization of surfaces and environments, it requires more time for a sanitizing action, it can be used in the presence of people or animals.*

- Strip led flessibile per la sanificazione di superfici e ambienti, bobina da 5 metri;
  - Sezionabile ad interassi prefissati ogni 10 cm;
  - Nastro adesivo 3M sul retro;
  - La doppia intestazione di cavi permette una connessione in serie più rapida.
  - Per la dissipazione termica è vivamente consigliato l'utilizzo di un profilo di alluminio di sezione adeguata.
- Flexible led strip for sanitizing surfaces and environments, 5 meter reel;
  - Can be sectioned at fixed distances every 8.4 cm;
  - 3M adhesive tape on the back;
  - The double header of cables allows a faster series connection.
  - For heat dissipation, the use of an aluminum profile with an adequate section is strongly recommended.

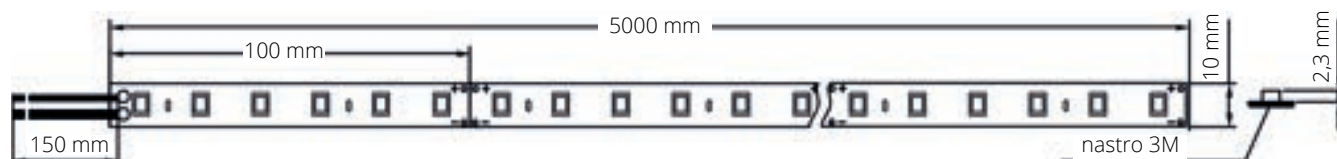

CODICE	DESCRIZIONE	IP	CONSUMO	W/MT	LED/MT	DC	LISTINO
SL60UVA20	STRIP LED UVA	20	70 W	14	60 UVA	24 V	110 €



## BARRE LED UVC-UVA



Le barre le UV Ledco si suddividono in 2 tipologie:

- Barre led UVC ad azione germicida totale, per la sanificazione e disinfezione di superfici ed ambienti.

La potenza germicida dei raggi UVC agisce in 20 minuti a distanza di 1 metro dalla superficie che vogliamo igienizzare, eliminando ogni tipo di micro-organismo, virus e batterio, compreso il COVID-19.

**IMPORTANTE:** non utilizzare la barra led UVC in presenza di persone o animali, la potente azione germicida delle barre led UVC non consente la presenza di alcun essere vivente durante l'azione della barra.

- Barre led UVA per una sanificazione di superfici e ambienti più blanda, richiede maggior tempo per una azione igienizzante, è possibile utilizzarla in presenza di persone o animali.

*The Ledco UV strips are divided into 2 types:*

- *UVC led strip with total germicidal action, for the sanitization and disinfection of surfaces and environments.*

*The germicidal power of UVC rays acts in 20 minutes at a distance of 1 meter from the surface we want to sanitize, eliminating all types of micro-organisms, viruses and bacteria, including COVID-19.*

***IMPORTANT: do not use the UVC LED strip in the presence of people or animals, the powerful germicidal action of the UVC LEDs does not allow the presence of any living being during the irradiation of light.***

- *UVA led strip for a milder sanitization of surfaces and environments, it requires more time for a sanitizing action, it can be used in the presence of people or animals.*

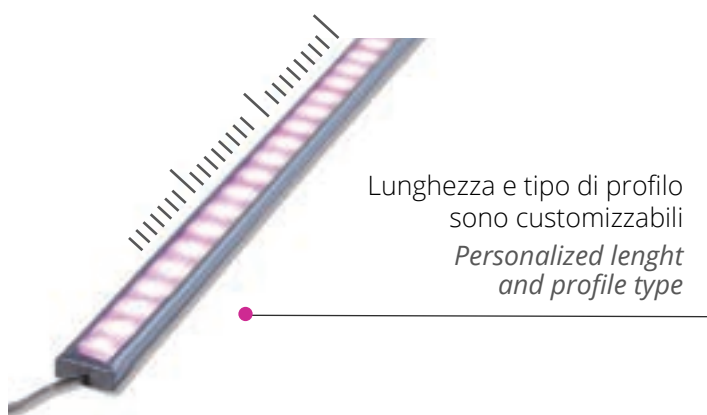

Lunghezza e tipo di profilo  
sono customizzabili  
*Personalized length  
and profile type*

CODICE	DESCRIZIONE	COLORE BARRA	LUNGHEZZA BARRA	LED/MT	POTENZA	DC	LISTINO
BL100110/UVC	Barra Led UVC	Silver	1 mt	12 UVC + 24 UVA	17W	24 V	200 €
BL100110/UVA	Barra Led UVA	Silver	1 mt	60 UVA	14 W	24 V	120 €



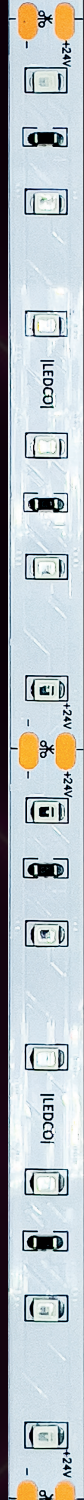



## ANCHE L'OCCHIO VUOLE LA SUA PARTE

Per chi non lascia nulla al caso, la cura dei dettagli è essenziale nella vendita. Questa strip led trasformerà il vostro banco in un'armonia di colori esaltando la naturale bellezza dei vostri prodotti.

## YOU SHOULD ALSO PLEASE THE EYE

*For those who leave nothing to chance, attention to detail is essential in the sale, this LED strip will transform your counter into a harmony of colors, enhancing the natural beauty of your products.*



- Strip led flessibile per illuminazione lineare con LED ad alta resa cromatica specifico per l'illuminazione degli alimenti
- Sezionabile ad interassi prefissati ogni 5 cm
- Nelle versioni IP65 utilizziamo un rivestimento protettivo in elastomero siliconico termo-dissipante con finitura diffondente (allunga la vita della strip all'esterno mantenendola trasparente e morbida nel tempo)
- Nastro adesivo 3M sul retro
- La doppia intestazione di cavi permette una connessione in serie più rapida
- Per la dissipazione termica è vivamente consigliato l'utilizzo di un profilo di alluminio di sezione adeguata

- Flexible strip led for linear lighting, with an high CRI led chip which provide a specific light for food
- Cuttable every 5 cm
- The IP65 version uses an silicon thermal-dissipating protective coating.
- 3M sticker tape on the strip back
- Cables on both sides guarantee a faster in series connection
- An appropriate aluminum profile section is required for thermal dissipation

• Elimina l'effetto puntinato con i profili! ( vedi pag. 118)  
 • Eliminate the dotted effect with profiles! (see page 118)

**Disponibile anche Barra Led Food** *Food led bar available*

- Pronta all'uso
- Dimensioni su misura

Contattaci per maggiori informazioni *Contact us for further information*

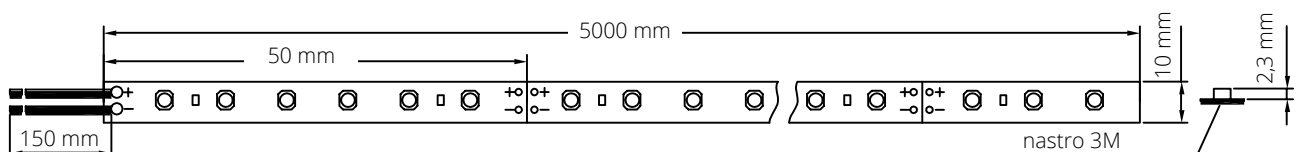

CODICE	IP	CONSUMO	W/MT	COLORE	LED/MT	LUMEN/MT	LUMEN	DC	LISTINO
SL120MT65	65	90 W	18	Carne	120	2200	11000	24 V	95 €
SL120GD65	65	90 W	18	Pane	120	2300	11500	24 V	95 €
SL120FH65	65	90 W	18	Pesce	120	2800	14000	24 V	95 €



# DIM TO WARM

Con il termine Dim to Warm si intende la particolare tecnologia LED con la quale è possibile ridurre la temperatura del colore di un corpo illuminante, offrendo così la possibilità di creare scenari accoglienti e rilassanti. L'obiettivo di questa tecnologia è quello di creare la sensazione di calore delle lampade alogene, senza rinunciare ai benefici della tecnologia LED.

*The term Dim to Warm refers to the particular LED technology with which it is possible to reduce the color temperature of a fixtures, thus offering the possibility of creating welcoming and relaxing scenarios. The aim of this technology is to create the sensation of warmth of halogen lamps, without renouncing the benefits of LED technology.*





# STRIP LED DIM TO WARM - CHIP 2835



- Strip led flessibile per illuminazione lineare con LED dinamico, può passare gradualmente da 3000K a 1800K riducendo la luminosità
- Bobina da 5 metri;
- Sezionabile ad interassi prefissati ogni 7,5 cm
- Nastro adesivo 3M sul retro
- La doppia intestazione di cavi permette una connessione in serie più rapida
- L'elevata densità dei led (196 chip per metro) consente un'illuminazione omogenea su tutte le superfici
- Per la dissipazione termica è vivamente consigliato l'utilizzo di un profilo di alluminio di sezione adeguata
- 3 Step MacAdam

- Flexible led strip for linear lighting with dynamic LED, it can gradually switch from 3000K to 1800K by reducing the brightness
- 5 meter reel
- Cuttable every 7,5 cm
- 3M sticker tape on the strip back
- Cables on both sides guarantee a faster in series connection
- High LED density (196 chip per meter) provides an uniform lighting on every surface
- An appropriate aluminum profile section is required for thermal dissipation
- 3 Step MacAdam

... Elimina l'effetto puntinato con i profili! ( vedi pag. 118)  
 Eliminate the dotted effect with profiles! (see page 118)

Per l'utilizzo di questo prodotto puoi scegliere uno dei dimmer PWM dalla sezione Accessori (pag. 189)  
 For using this product you can choose one of the PWM dimmers from the Accessories section (page 189)

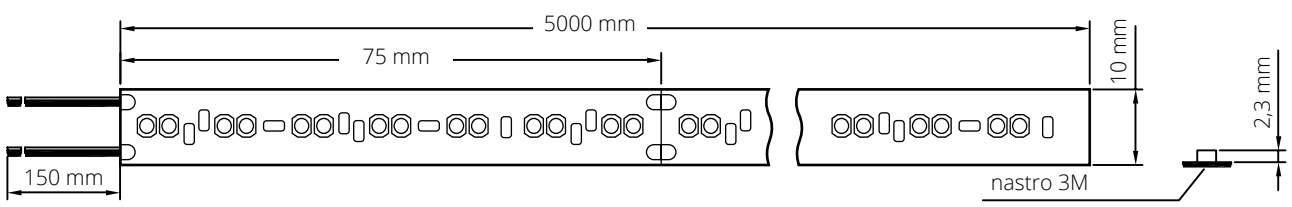

CODICE	IP	CONSUMO	W/MT	COLORE	LED/MT	LUMEN/MT	LUMEN	DC	LISTINO
SL196DTW20	20	80 W	16 W	30000 - 1800 K	196	1470	7350	24 V	150 €

120°  
LED'S ANGLE

IP20  
INTERNAL USE

RoHS  
CERTIFICATE

CE  
CERTIFICATE

DC 24  
LOW VOLTAGE SAFETY

2 year  
WARRANTY

# BIANCO DINAMICO

## FREDDO O CALDO?

Hai mai desiderato cambiare temperatura di colore senza dover cambiare il tuo impianto? Ora puoi farlo, passa dalla luce fredda alla luce calda sfiorando il telecomando touch così da rendere il tuo negozio o la tua casa più confortevoli.

# DYNAMIC WHITE

## COLD OR WARM?

*Have you ever wanted to change color temperature without having to change your system? Now you can do it, switch from cold light to warm light by touching the touch remote control to make your shop or home more comfortable.*



## STRIP LED BIANCO DINAMICO - CHIP 2835

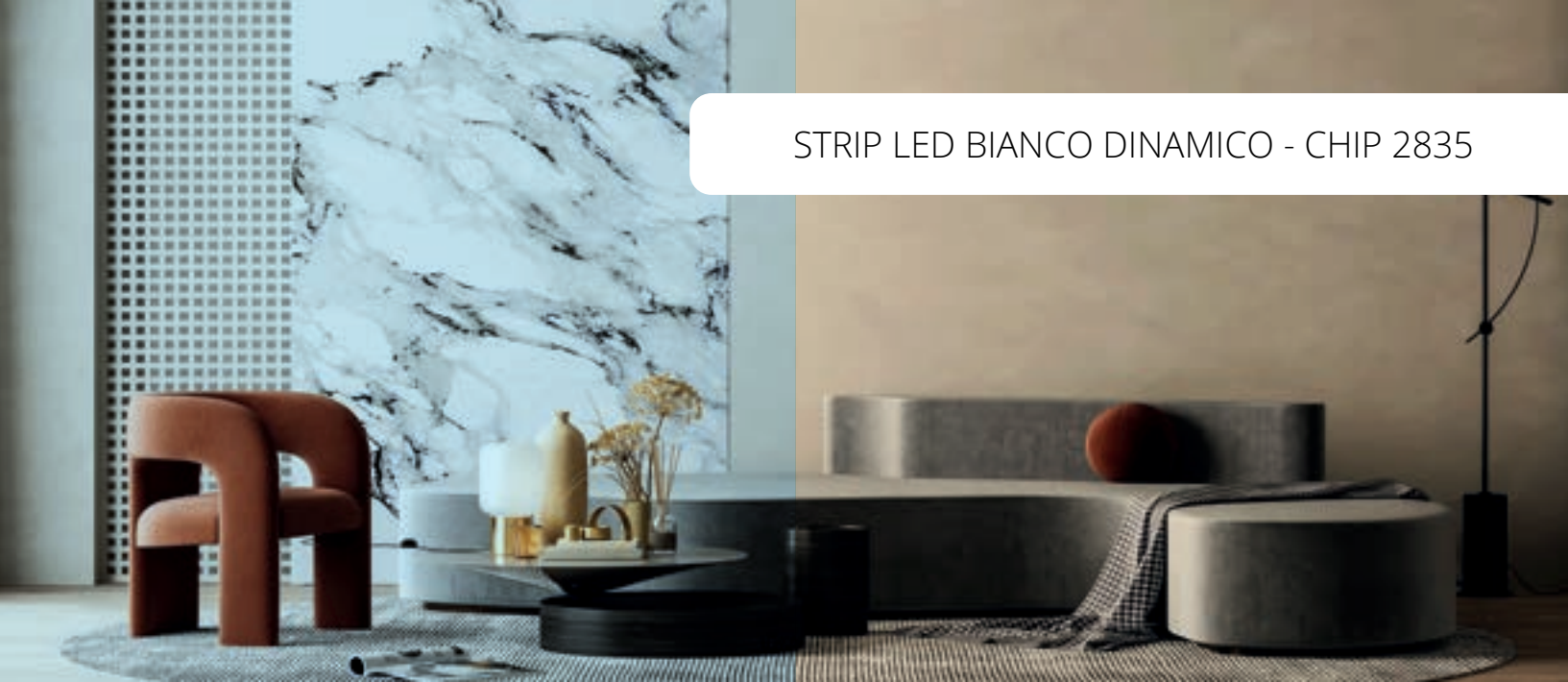

- Strip led flessibile per illuminazione lineare con LED dinamico, può passare gradualmente da 2700K a 6000K
- Sezionabile ad interassi prefissati ogni 10 cm
- Nastro adesivo 3M sul retro
- La doppia intestazione di cavi permette una connessione in serie più rapida
- L'elevata densità dei led (120 chip per metro) consente un'illuminazione omogenea su tutte le superfici
- Per la dissipazione termica è vivamente consigliato l'utilizzo di un profilo di alluminio di sezione adeguata
- 3 Step MacAdam

- *Flexible Strip with dynamic chip LED, you can adjust the colour temperature from 2700K to 6000K*
- *Cuttable every 10 cm*
- *3M sticker tape on the strip back*
- *Cables on both sides guarantee a faster in series connection*
- *High LED density (120 chip per meter) provides an uniform lightning on every surface*
- *An appropriate aluminum profile section is required for thermal dissipation*
- *3 Step MacAdam*

... Elimina l'effetto puntinato con i profili! (vedi pag. 118)  
Eliminate the dotted effect with profiles! (see page 118)

### CT900 - 85€

Centralina con telecomando RF specifico per strip Bianco Dinamico consente un controllo totale della temperatura del colore, passando da 2700 a 6000 K.

*Control unit with specific RF remote control for Dynamic White strip allows total control of the color temperature, going from 2700 to 6000 K.*



### CT910 - 70€

Amplificatore Bianco Dinamico  
*Dynamic White Amplifier*

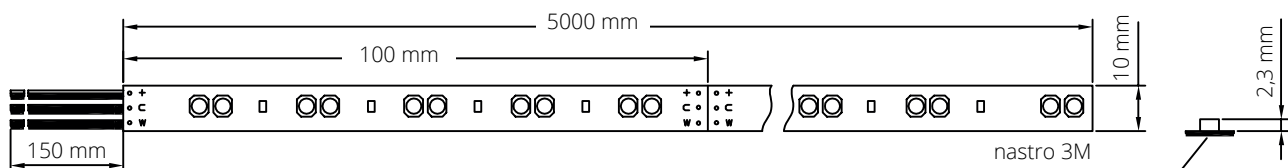

CODICE	IP	CONSUMO	W/MT	COLORE	LED/MT	LUMEN/MT	LUMEN	DC	LISTINO
SL120BD20	20	80 W	16 W	2700 - 6000 K	120	1500	7500	24 V	95 €





# WAVY STRIP

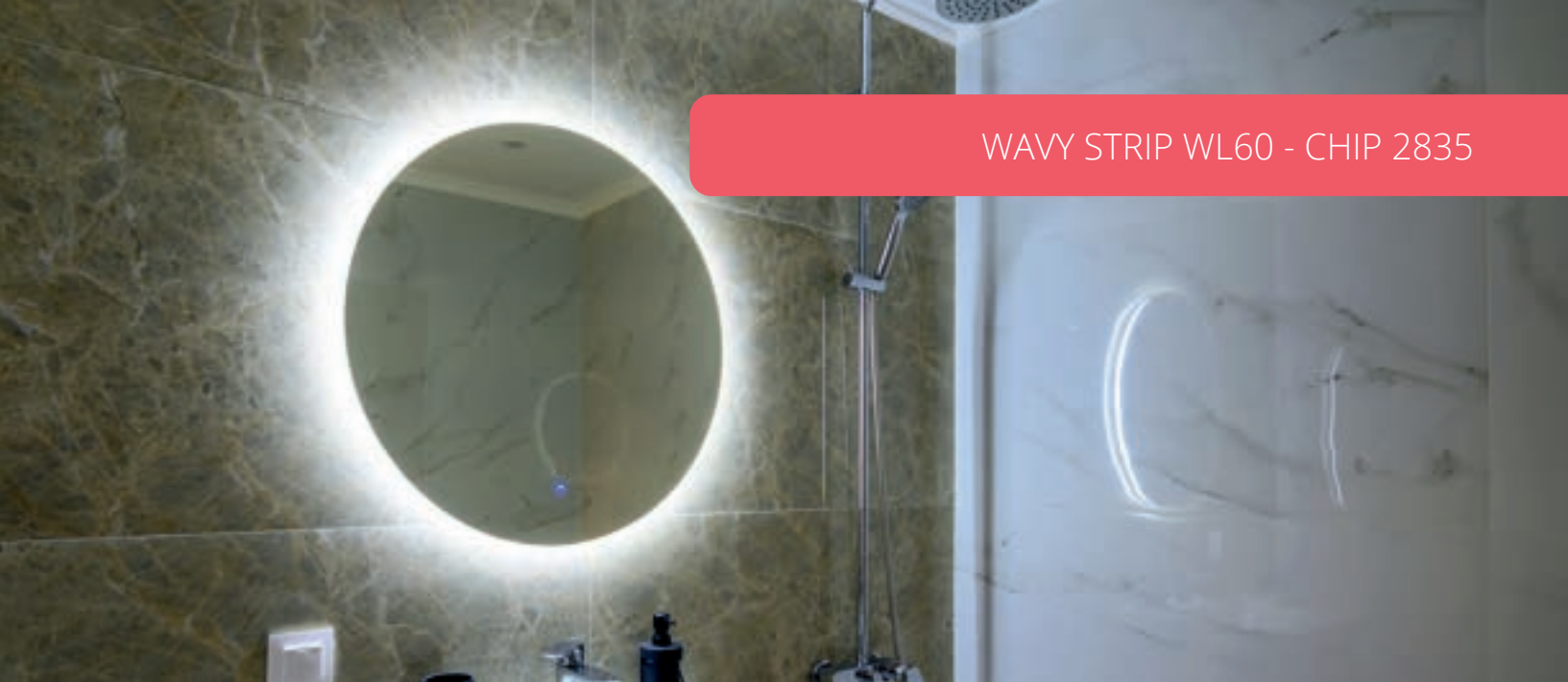

Grazie al particolare design ad "onda" del circuito stampato è possibile piegarla senza doverla tagliare. Si possono creare angoli o curve particolari con un grande risparmio di tempo a tutto vantaggio della praticità e del risultato estetico finale.

*The printed circuit's particular wavy design makes it easy to bend without cutting. It's also possible to create angles and curves saving time with a perfect aesthetic result.*

- Strip flessibile per illuminazione lineare con LED monocromatico, bobina da 5 metri.
- Sezionabile ad interassi prefissati ogni 10 cm
- Le versioni IP54 sono completamente rivestite di nano particelle che le rendono impermeabili all'acqua.
- Nastro adesivo 3M sul retro.
- La doppia intestazione dei cavi permette una connessione in serie più rapida
- 3 Step MacAdam

- The 5 meters flexible reel provides a linear monochromatic LED lightning
- Cuttable on fixed point 10 cm
- The IP54 version uses an silicon thermal-dissipating protective coating.
- 3M sticker tape on the strip back.
- Cables on both sides guarantee a faster in series connection
- 3 Step MacAdam

••• Elimina l'effetto puntinato con i profili! ( vedi pag. 118)  
 Eliminate the dotted effect with profiles! (see page 118)



L'utilizzo del rivestimento in nano particelle (conformal coating) non altera l'aspetto della strip, garantendo protezione all'acqua (IP54) e una migliore dissipazione termica.

*The IP54 nano particles cover doesn't change the external aspect of the strip but it guarantees a waterproof effect and a better heat dissipation.*

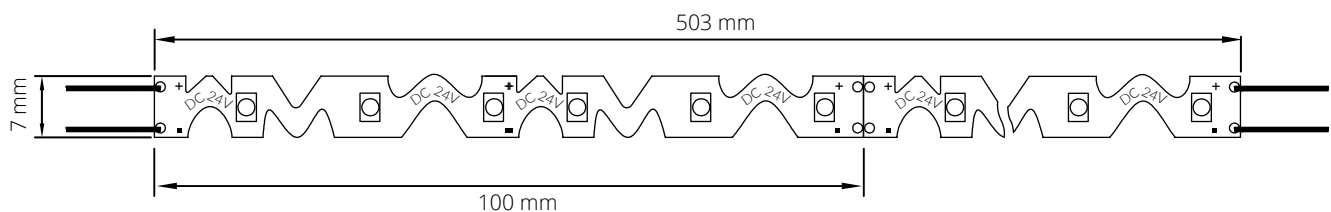

CODICE	IP	CONSUMO	W/MT	COLORE	LED/MT	LUMEN/MT	LUMEN	DC	LISTINO
WL60LBC65/N	54	60 W	12	3000 K	60	1420	7100	24 V	95 €
WL60LBN65/N	54	60 W	12	4000 K	60	1460	7300	24 V	95 €
WL60LBI65/N	54	60 W	12	6000 K	60	1500	7500	24 V	95 €





# STRIP LED WATERPROOF

Strip adatta al montaggio esterno e in immersione, anche in acqua clorata e salata. La nuova tecnologia di doppia protezione al silicone la rende adatta agli utilizzi più gravosi.

*Strip suitable for both external and immersion mounting, also in chlorinated and salty water. The new silicone double protection technology makes it suitable for the heaviest uses.*



GUARDA IL VIDEO



See the video



# STRIP LED SL200 IP67 - CHIP 2835



- Strip led flessibile per illuminazione lineare con LED monocromatico, bobina da 5 metri
- Sezionabile ad interassi prefissati ogni 2,5 cm
- Nastro adesivo 3M VHB ad alto potere adesivo anche in ambienti umidi e su profili verniciati a polveri
- La doppia intestazione di cavi con guaina in neoprene permette anche la connessione stagna tramite pressacavo
- L'elevata densità dei led (240 chip per metro) consente un'illuminazione omogenea su tutte le superfici
- Prodotto adatto all'installazione in ambienti esterni o ad immersione, anche in acqua clorata e salata
- Chip con CRI90+ e 3 Step MacAdam

- Flexible led strip for linear lighting with monochromatic LEDs, 5 meter reel
- Can be sectioned at pre-set distances every 2.5 cm
- 3M VHB adhesive tape with high adhesive power even in humid environments and on powder coated profiles
- The double header of cables with neoprene sheath also allows watertight connection via cable gland
- The high density of the LEDs (240 chips per metre) allows homogeneous lighting on all surfaces
- Product suitable for installation in outdoor environments or by immersion, even in chlorinated and salt water
- Chips with CRI90+ and 3 Step MacAdam

• Elimina l'effetto puntinato con i profili! ( vedi pag. 118)  
 • Eliminate the dotted effect with profiles! ( see page 118)

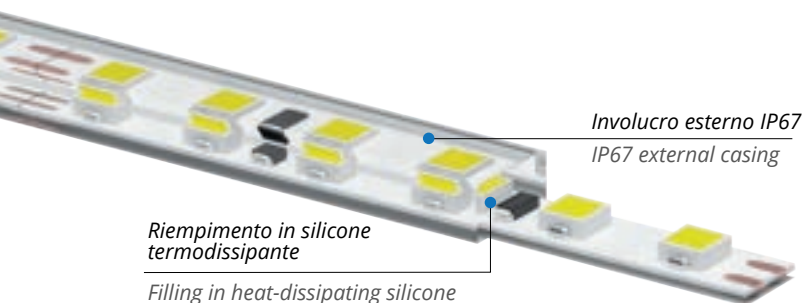

## ACCESSORI - ACCESSORIES

- EN720** - € 0,80  
Tappo di chiusura  
End Cap
- SILICONE** - € 2,50  
Tubetto silicone 10ml  
10ml silicone tube
- EN720/1** - € 0,80  
Tappo forato  
End Cap with hole
- EN68/12** - € 1,00  
Staffe per montaggio a parete  
Brackets for wall mounting

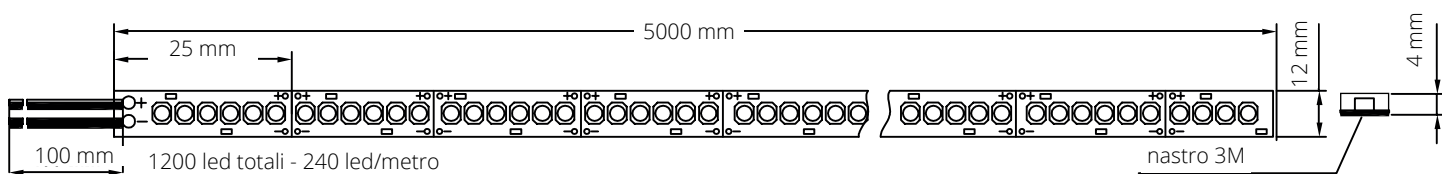

\*con l'aggiunta del tappo la larghezza sarà 15mm, lo spessore 5mm | \*with the addition of the cap the width will be 15mm, the thickness 5mm

	CODICE	IP	CONSUMO	W/MT	COLORE	LED/MT	LUMEN/MT	LUMEN	DC	LISTINO
<b>2700K</b>	SL200LBH67	67	100 W	20 W	2700 K	240	3530	17650	24 V	150 €
	SL200LBC67	67	100 W	20 W	3000 K	240	3725	18625	24 V	150 €
	SL200LBN67	67	100 W	20 W	4000 K	240	3825	19125	24 V	150 €
	SL200LBI67	67	100 W	20 W	6000 K	240	3920	19600	24 V	150 €

**IP20**

Puoi trovare la versione IP20 a pag. 58  
 You can find the IP20 version on page 58







# STRIP LED SL200 IP67 ES - CHIP 2835



- Strip led flessibile per illuminazione lineare con LED monocromatico, bobina da 5 metri
- Sezionabile ad interassi prefissati ogni 2,5 cm
- Nastro adesivo 3M VHB ad alto potere adesivo anche in ambienti umidi e su profili verniciati a polveri
- La doppia intestazione di cavi con guaina in neoprene permette anche la connessione stagna tramite pressacavo
- L'elevata densità dei led (240 chip per metro) consente un'illuminazione omogenea su tutte le superfici
- Prodotto adatto all'installazione in ambienti esterni o ad immersione, anche in acqua clorata e salata
- Chip con CRI90+ e 3 Step MacAdam

- Flexible led strip for linear lighting with monochromatic LEDs, 5 meter reel
- Can be sectioned at pre-set distances every 2.5 cm
- 3M VHB adhesive tape with high adhesive power even in humid environments and on powder coated profiles
- The double header of cables with neoprene sheath also allows watertight connection via cable gland
- The high density of the LEDs (240 chips per metre) allows homogeneous lighting on all surfaces
- Product suitable for installation in outdoor environments or by immersion, even in chlorinated and salt water
- Chips with CRI90+ and 3 Step MacAdam

... Elimina l'effetto puntinato con i profili! ( vedi pag. 118)  
Eliminate the dotted effect with profiles! (see page 118)

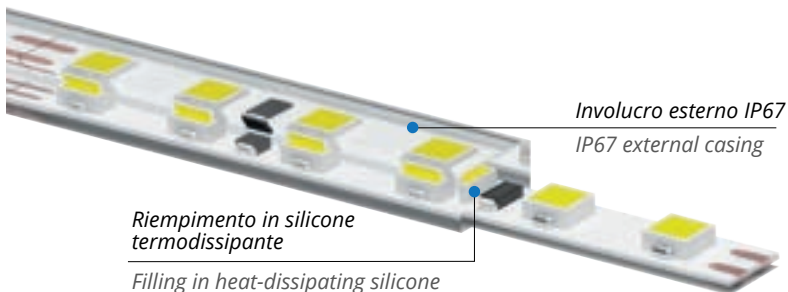

## ACCESSORI - ACCESSORIES

- EN720** - € 0,80  
Tappo di chiusura  
End Cap
- EN720/1** - € 0,80  
Tappo forato  
End Cap with hole
- SILICONE** - € 2,50  
Tubetto silicone 10ml  
10ml silicone tube
- EN68/12** - € 1,00  
Staffe per montaggio a parete  
Brackets for wall mounting

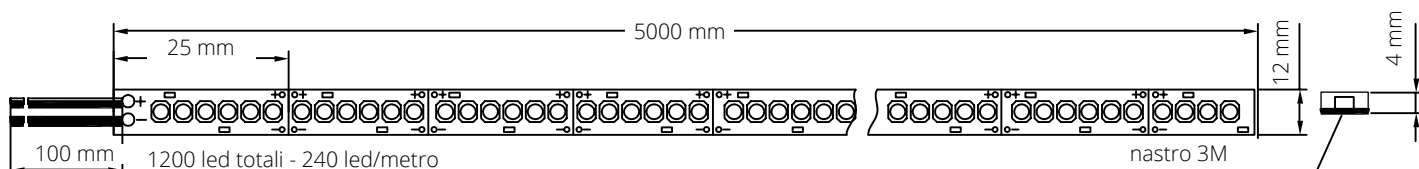

\*con l'aggiunta del tappo la larghezza sarà 15mm, lo spessore 5mm | \*with the addition of the cap the width will be 15mm, the thickness 5mm

	CODICE	IP	CONSUMO	W/MT	COLORE	LED/MT	LUMEN/MT	LUMEN	DC	LISTINO
	SL200LBH67/ES	67	60 W	12 W	2700 K	240	2255	11275	24 V	145 €
	SL200LBC67/ES	67	60 W	12 W	3000 K	240	2355	11775	24 V	145 €
	SL200LBN67/ES	67	60 W	12 W	4000 K	240	2450	12250	24 V	145 €
	SL200LBI67/ES	67	60 W	12 W	6000 K	240	2550	12750	24 V	145 €

**IP20**

Puoi trovare la versione IP20 a pag. 59  
You can find the IP20 version on page 59



# STRIP LED SL125 IP68 - CHIP 2835



- Strip led flessibile per illuminazione lineare con LED monocromatico, bobina da 5 metri
  - Sezionabile ad interassi prefissati ogni 5 cm
  - Nastro adesivo 3M VHB ad alto potere adesivo anche in ambienti umidi e su profili verniciati a polveri
  - La doppia intestazione di cavi con guaina in neoprene permette anche la connessione stagna tramite pressacavo
  - Prodotto adatto all'installazione con e senza profilo anche in ambienti esterni o ad immersione, anche in acqua colorata e salata
  - 3 Step MacAdam
- *The 5 meters flexible reel provides a linear monochromatic LED lightning*
  - *Cutttable every 5 cm*
  - *3M VHB sticker tape guarantee a perfect adhesiveness outdoor and also on powder painted profiles*
  - *Cables on both sides guarantee a faster in series connection*
  - *Neoprene cables on both sides guarantee a safe outdoor connection, also in colored and salty water*
  - *3 Step MacAdam*

... Elimina l'effetto puntinato con i profili! ( vedi pag. 118)  
Eliminate the dotted effect with profiles! (see page 118)

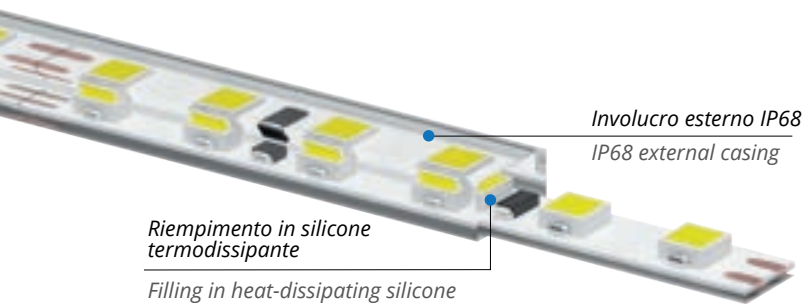

## ACCESSORI - ACCESSORIES



**EN125** - € 0,80  
Tappo di chiusura  
End Cap



**SILICONE** - € 2,50  
Tubetto silicone 10ml  
10ml silicone tube



**EN125/1** - € 0,80  
Tappo forato  
End Cap with hole



**EN68/7** - € 1,00  
Staffe per montaggio a parete  
Brackets for wall mounting



L'innovativa doppia protezione in silicone + PVC (tubo esterno in PVC più riempimento ad iniezione interno) garantisce al prodotto la massima impermeabilità all'acqua, anche in immersione totale.

*The new full PVC + silicon protection guarantee the waterproof grade also in complete water immersion.*

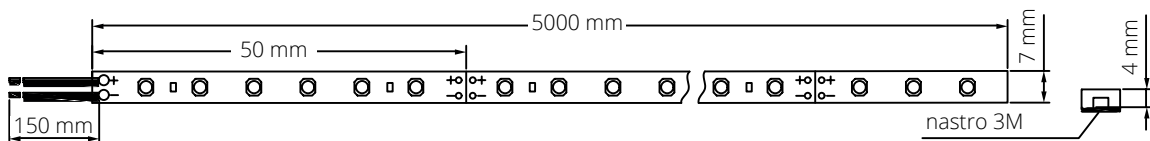

\*con l'aggiunta del tappo la larghezza sarà 10mm, lo spessore 5mm | \*with the addition of the cap the width will be 10mm, the thickness 5mm

CODICE	IP	CONSUMO	W/MT	COLORE	LED/MT	LUMEN/MT	LUMEN	DC	LISTINO
SL125LBC68	68	60 W	12 W	3000 K	120	1390	6950	24 V	125 €
SL125LBN68	68	60 W	12 W	4000 K	120	1430	7150	24 V	125 €
SL125LBI68	68	60 W	12 W	6000 K	120	1470	7350	24 V	125 €

**IP20**

Puoi trovare la versione IP20 a pag. 61  
You can find the IP20 version on page 61





# STRIP LED 48V IP68 - CHIP 2835

## 30 metri



- Strip led flessibile per illuminazione lineare con LED monocromatico, bobina da 30 metri
- Sezionabile ad interassi prefissati ogni 12,5 cm
- Nastro adesivo 3M 300LSE sul retro, alto potere adesivo anche su profili verniciati a polveri.
- La doppia intestazione di cavi permette una connessione in serie più rapida
- I circuiti integrati a bordo della strip rilanciano la corrente, permettendo di raggiungere 30 metri con un solo punto di alimentazione
- Chip CRI90+ e 3 Step MacAdam
- The 30 meters flexible reel provides a linear monochromatic LED lightning
- Cuttable every 12,5 cm
- 3M 300LSE sticker tape guarantee a perfect adhesiveness also on powder painted profiles
- Cables on both sides guarantee a faster in series connection
- Integrated Circuit on board allow to power on 30 meter of strip led without voltage drop
- CRI90+ and 3 Step MacAdam chip LED

... Elimina l'effetto puntinato con i profili! ( vedi pag. 118)  
 Eliminate the dotted effect with profiles! (see page 118)

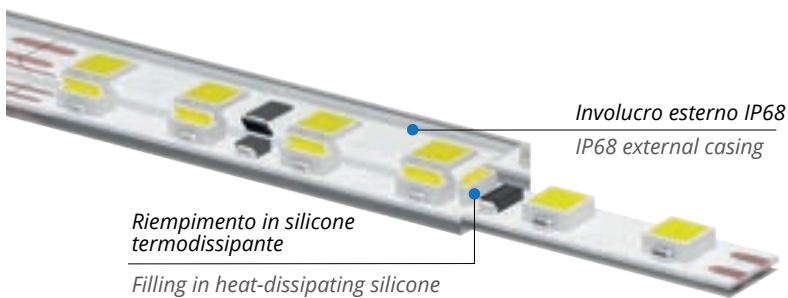

### ACCESSORI - ACCESSORIES

- EN720** - € 0,80  
Tappo di chiusura  
End Cap
- SILICONE** - € 2,50  
Tubetto silicone 10ml  
10ml silicone tube
- EN720/1** - € 0,80  
Tappo forato  
End Cap with hole
- EN68/12** - € 1,00  
Staffe per montaggio a parete  
Brackets for wall mounting

**30mt**  
con un punto di  
alimentazione

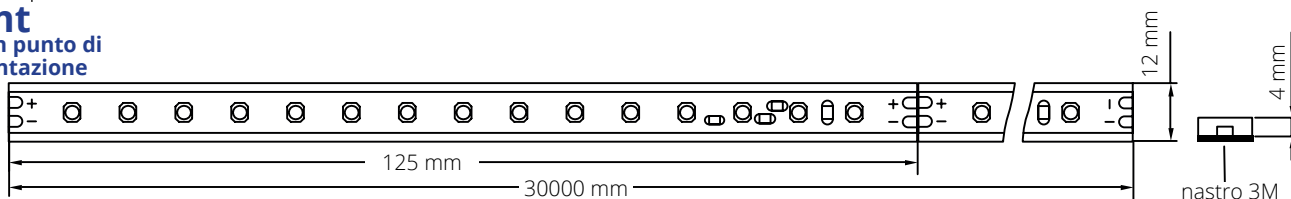

\*con l'aggiunta del tappo la larghezza sarà 13mm, lo spessore 6mm | \*with the addition of the cap the width will be 13mm, the thickness 6mm

## 30 metri

CODICE	IP	W/MT	COLORE	LED/MT	LUMEN/MT	DC	LISTINO
SL120LBC68/48	68	8 W	3000 K	120	1410	48 V	33,50 €/mt
SL120LBN68/48	68	8 W	4000 K	120	1450	48 V	33,50 €/mt
SL120LBI68/48	68	8 W	6000 K	120	1490	48 V	33,50 €/mt

**IP20** Puoi trovare la versione IP20 a pag. 70  
 You can find the IP20 version on page 70

Disponibile in lunghezze customizzate fino ad un massimo di 30 metri.  
 Available in customized lengths up to a maximum of 30 meters.



# STRIP LED RGB IP68 - CHIP 5050

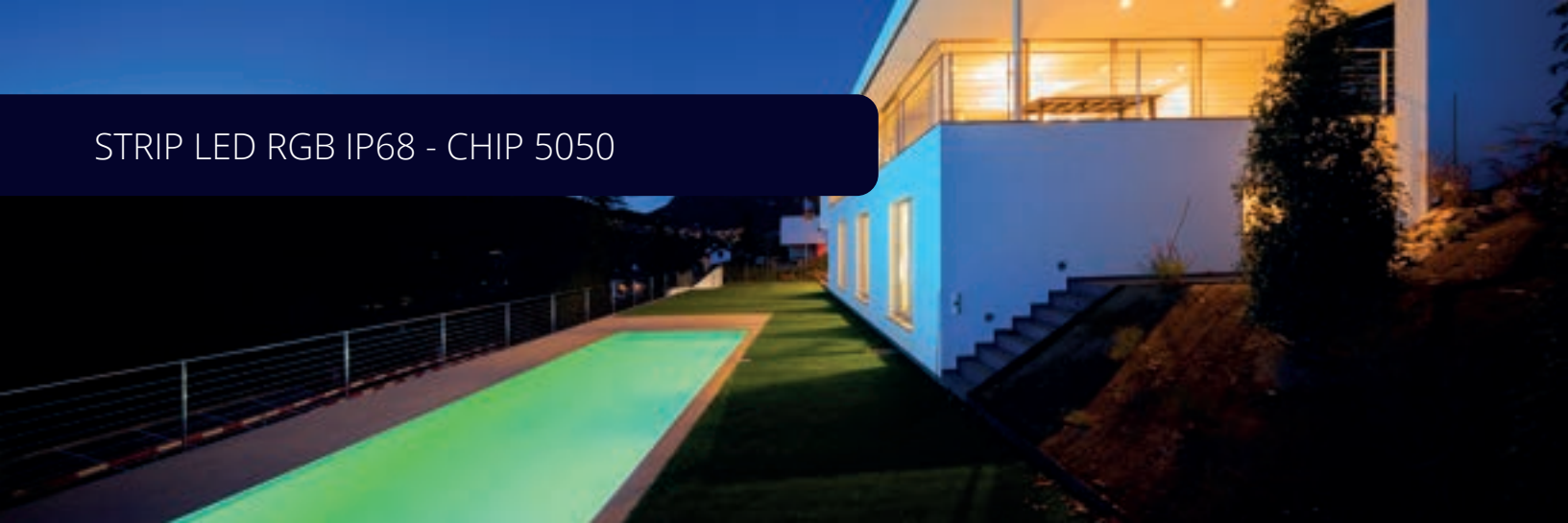

- Strip led flessibile per illuminazione lineare con LED RGB, bobina da 5 metri
- Sezionabile ad interassi prefissati ogni 10 cm
- Nastro adesivo 3M VHB ad alto potere adesivo anche in ambienti umidi e su profili verniciati a polveri
- La doppia intestazione di cavi con guaina in neoprene permette anche la connessione stagna tramite pressacavo
- Prodotto adatto all'installazione con e senza profilo anche in ambienti esterni o ad immersione, anche in acqua colorata e salata
- 3 Step MacAdam
- *The 5 meters flexible reel provides a linear RGB LED lighting*
- *Cuttable every 10 cm*
- *3M VHB sticker tape guarantee a perfect adhesiveness outdoor and also on powder painted profiles*
- *Cables on both sides guarantee a faster in series connection*
- *Neoprene cables on both sides guarantee a safe outdoor connection, also in colored and salty water*
- *3 Step MacAdam*

... Elimina l'effetto puntinato con i profili! ( vedi pag. 116)  
Eliminate the dotted effect with profiles! ( see page 116)

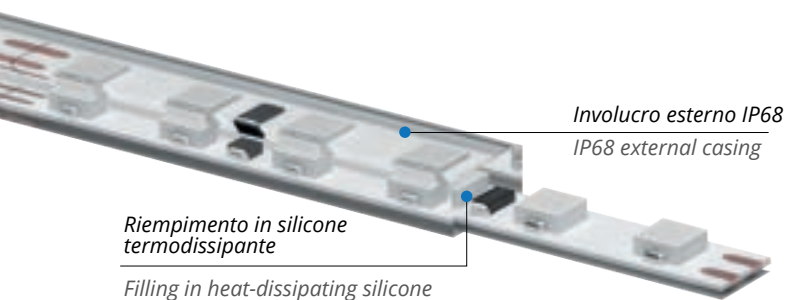

## ACCESSORI - ACCESSORIES



**EN720** - € 0,80  
Tappo di chiusura  
End Cap



**SILICONE** - € 2,50  
Tubetto silicone 10ml  
10ml silicone tube



**EN720/1** - € 0,80  
Tappo forato  
End Cap with hole



**EN68/12** - € 1,00  
Staffe per montaggio a parete  
Brackets for wall mounting



L'innovativa doppia protezione in silicone + PVC (tubo esterno in PVC più riempimento ad iniezione interno) garantisce al prodotto la massima impermeabilità all'acqua, anche in immersione totale.

*The new full PVC + silicon protection guarantee the waterproof grade also in complete water immersion.*

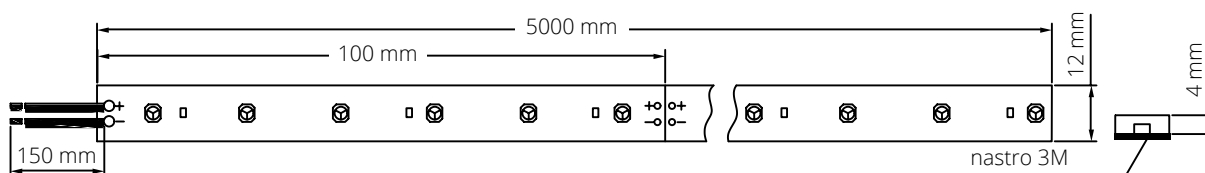

\*con l'aggiunta del tappo la larghezza sarà 13mm, lo spessore 6mm | \*with the addition of the cap the width will be 13mm, the thickness 6mm

CODICE	IP	CONSUMO	W/MT	COLORE	LED/MT	LUMEN/MT	LUMEN	DC	LISTINO
SL72RGB68	68	72 W	14,4W	RGB	60	1080	5400	24 V	125 €

**IP20**

Puoi trovare la versione IP20 a pag. 98  
You can find the IP20 version on page 98

**IP65**

Puoi trovare la versione IP65 a pag. 98  
You can find the IP65 version on page 98





- Strip led flessibile per illuminazione lineare con LED RGB.W, bobina da 5 metri
- Sezionabile ad interassi prefissati ogni 10 cm
- Nastro adesivo 3M VHB ad alto potere adesivo anche in ambienti umidi e su profili verniciati a polveri
- La doppia intestazione permette anche la connessione stagna tramite pressacavo
- Prodotto adatto all'installazione con e senza profilo anche in ambienti esterni o ad immersione, anche in acqua clorata e salata
- 3 Step MacAdam

- Flexible strip for linear lighting with RGB.W LEDs, 5-meter reel
- Cuttable every 10 cm
- 3M VHB sticker tape guarantee a perfect adhesiveness outdoor and also on powder painted profiles
- The double header also allows watertight connection via cable gland
- Product suitable for installation with and without profile also in external environments or in immersion, even in chlorinated and salt water
- 3 Step MacAdam

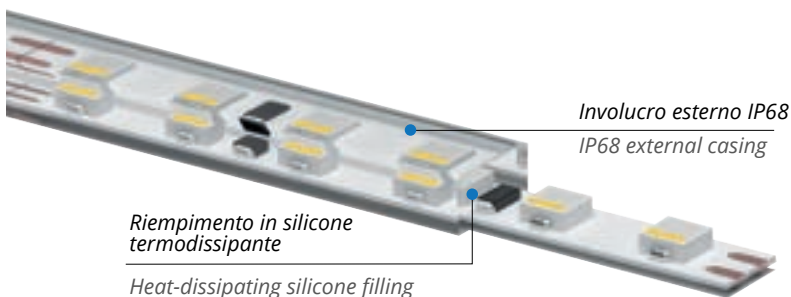

## ACCESSORI - ACCESSORIES

- EN720** - € 0,80  
Tappo di chiusura  
End Cap
- EN720/1** - € 0,80  
Tappo forato  
End Cap with hole
- SILICONE** - € 2,50  
Tubetto silicone 10ml  
10ml silicone tube
- EN68/12** - € 1,00  
Staffe per montaggio a parete  
Brackets for wall mounting



L'innovativa doppia protezione in silicone + PVC (tubo esterno in PVC più riempimento ad iniezione interno) garantisce al prodotto la massima impermeabilità all'acqua, anche in immersione totale.

The new full PVC + silicon protection guarantee the waterproof grade also in complete water immersion.

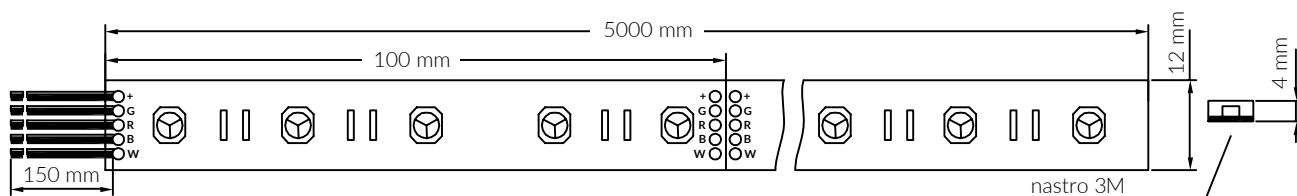

CODICE	IP	CONSUMO	W/MT	COLORE	LED/MT	LUMEN/MT	LUMEN	DC	LISTINO
SL72RGBW68	68	95 W	19	RGB.W 3000	60	1400	7000	24 V	145 €
SL72RGBW68/LBN	68	95 W	19	RGB.W 4000	60	1450	7250	24 V	145 €

**IP20**



Puoi trovare la versione IP20 a pag. 100  
You can find the IP20 version on page 100

**IP65**



Puoi trovare la versione IP65 a pag. 100  
You can find the IP65 version on page 100



# STRIP LED SAUNA

La Strip LED Sauna è una striscia impermeabile IP65 resistente alle alte temperature che può funzionare in saune e bagni turchi con temperature ambiente fino a 105°C.

*Sauna LED strip is a high-temperature resistance, IP65 waterproof LED strip that can work in saunas and steam rooms with ambient temperatures up to 105°C.*



**NEW**

# STRIP LED SAUNA - CHIP 3030

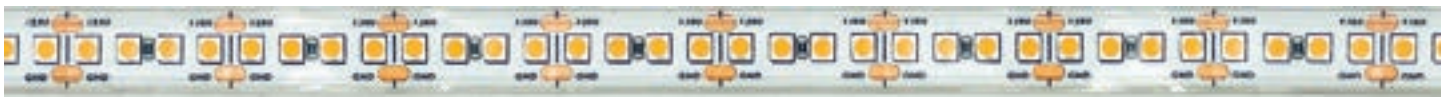

- Strip led flessibile per illuminazione lineare con LED monocromatico, bobina da 5 metri
- Sezionabile ad interassi prefissati ogni 2,2 cm
- Nastro adesivo 3M VHB ad alto potere adesivo anche in ambienti umidi e su profili verniciati a polveri
- La doppia intestazione di cavi con guaina in neoprene permette anche la connessione stagna tramite pressacavo
- Prodotto adatto all'installazione con e senza profilo anche in ambienti umidi e ad alta temperature fino a 105°C.
- 3 Step MacAdam
- The 5 meters flexible reel provides a linear monochromatic LED lighting
- Cuttable every 2,2 cm
- 3M VHB sticker tape guarantee a perfect adhesiveness outdoor and also on powder painted profiles
- Cables on both sides guarantee a faster in series connection
- Product suitable for installation with and without profile even in humid environments and at high temperatures up to 105°C.
- 3 Step MacAdam



Strip LED resistente al calore fino a 105°C.  
Heat resistant LED strip up to 105°C.

**LUMILEDS**

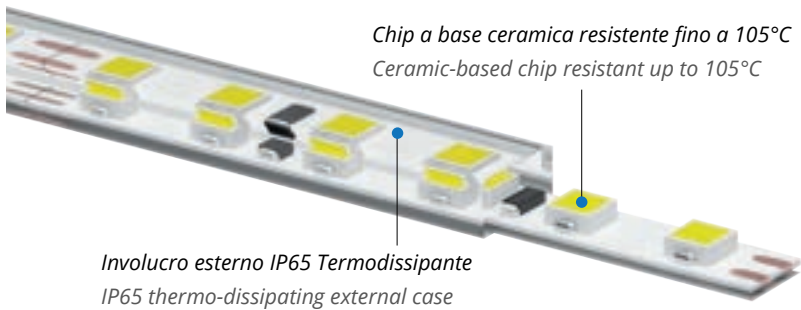

### ACCESSORI - ACCESSORIES

- EN125** - € 0,80  
Tappo di chiusura  
End Cap
- EN125/1** - € 0,80  
Tappo forato  
End Cap with hole
- SILICONE** - € 2,50  
Tubetto silicone 10ml  
10ml silicone tube
- EN68/7** - € 1,00  
Staffe per montaggio a parete  
Brackets for wall mounting

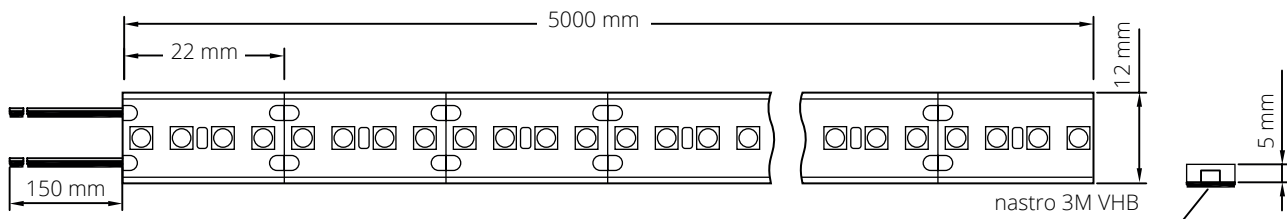

CODICE	IP	CONSUMO	W/MT	COLORE	LED/MT	LUMEN/MT	LUMEN	DC	LISTINO
SL184LBG65	65	50 W	10	2200 K	184	1480	7400	24 V	300 €

A silhouette of a person standing in a modern interior space. The room is illuminated by a long, horizontal LED strip light fixture mounted on the ceiling, which casts a warm, orange glow. The walls are a deep red color, and the floor is dark. The overall atmosphere is contemporary and minimalist.

# STRIP LED **SPECIAL**



## STRIP LED MONOCROMATICHE - CHIP 2835



- Strip flessibile per illuminazione lineare con LED rgb monocromatico, bobina da 5 metri
- Sezionabile ad interassi prefissati ogni 10 cm
- Le versioni IP54 sono completamente rivestite di nano particelle che le rendono impermeabili all'acqua
- Nastro adesivo 3M sul retro
- La doppia intestazione dei cavi permette una connessione in serie più rapida
- *The 5 meters flexible reel provides a linear monochromatic LED lightning*
- *Cuttable on fixed point every 10 cm*
- *The IP54 version uses the nano particles which make it waterproof*
- *3M sticker tape on the strip back*
- *Cables on both sides guarantee a faster in series connection*



L'utilizzo del rivestimento in nano particelle (conformal coating) non altera l'aspetto della strip, garantendo protezione all'acqua (IP54) e una migliore dissipazione termica.

*The IP54 nano particles cover doesn't change the external aspect of the strip but it guarantees a waterproof effect and a better heat dissipation.*

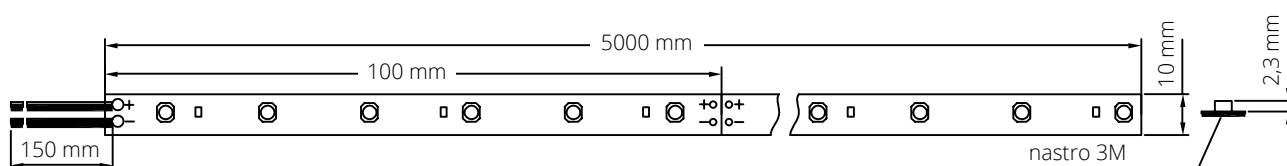

CODICE	IP	CONSUMO	W/MT	COLORE	LED/MT	LUMEN/MT	LUMEN	DC	LISTINO
SL60BL65/N	54	60 W	12 W	BLU	60	1100	5500	24 V	85 €
SL60RO65/N	54	60 W	12 W	ROSSO	60	1100	5500	24 V	85 €
SL60VE65/N	54	60 W	12 W	VERDE	60	1100	5500	24 V	85 €

In caso di installazioni di strip IP54 con nanoparticelle a diretto e continuo contatto con acqua, è necessario dopo il montaggio ripassare il prodotto con spray tipo H2OFF, in particolar modo nei punti di saldatura. Per installazioni a continuo contatto con acqua o parziale immersione si consigliano i prodotti IP68 (pag. 88) o i prodotti della serie Flex Custom (pag. 106).

*In case of installation of IP54 strips with nanoparticles, in direct and continuous contact with water, it is necessary after assembly to wipe the product again with spray type H2OFF, especially in the welding points. For installations in continuous contact with water or partial immersion, the recommended products are IP68 (page 88) or the products of the Flex Custom series (page 106).*



# STRIP LED RGB - CHIP 5050



- Strip flessibile per illuminazione lineare con LED RGB multicolore, bobina da 5 metri
- Sezionabile ad interassi prefissati ogni 10 cm
- Nelle versioni IP65 utilizziamo un rivestimento protettivo in elastomero siliconico termo-dissipante con finitura diffondente (allunga la vita della strip all'esterno mantenendola trasparente e morbida nel tempo)
- Nastro adesivo 3M sul retro
- La doppia intestazione dei cavi permette una connessione in serie più rapida
- The 5 meters flexible reel provides a linear multi chromatic LED lighting
- Cuttable on fixed point every 10 cm
- The IP65 version uses a silicon thermal-dissipating protective coating
- 3M sticker tape on the strip back
- Cables on both sides guarantee a faster in series connection



## Controller ed Accessori

Controller and Accessories

pag. 189

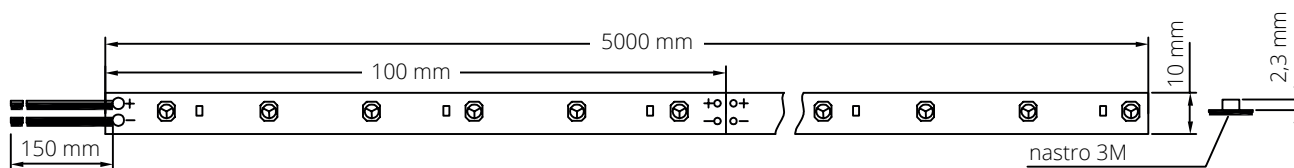

CODICE	IP	CONSUMO	W/MT	COLORE	LED/MT	LUMEN/MT	LUMEN	DC	LISTINO
SL72RGB20	20	72 W	14,4 W	RGB	60	1080	5400	24 V	75 €
SL72RGB65	65	72 W	14,4 W	RGB	60	1080	5400	24 V	80 €

**IP68**



Puoi trovare la versione IP68 a pag. 92  
You can find the IP68 version on page 92



**RGB  
60 LED/METRO**

RGB  
60 LED/METER

**NUOVA RGB  
240 LED/METRO**

NEW RGB  
240 LED/METER



- Strip flessibile per illuminazione lineare con LED RGB multicromatico, bobina da 5 metri
- Sezionabile ad interassi prefissati ogni 2,5 cm
- Nastro adesivo 3M sul retro
- La doppia intestazione dei cavi permette una connessione in serie più rapida

- Flexible strip for linear lighting with multi chromatic RGB LEDs, 5-meter reel
- Cuttable on fixed point every 2,5 cm
- 3M sticker tape on the strip back
- Cables on both sides guarantee a faster in series connection



**Controller ed Accessori**

Controller and Accessories

pag. 189

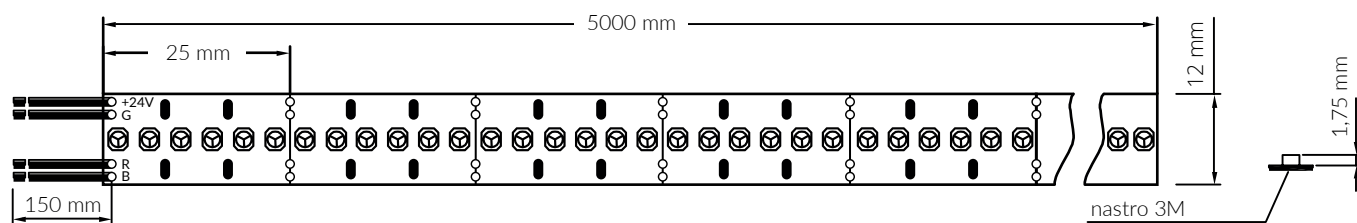

CODICE	IP	CONSUMO	W/MT	COLORE	LED/MT	LUMEN/MT	LUMEN	DC	LISTINO
SL200RGB20	20	100 W	20	RGB	240	1440	7200	24 V	250 €



# STRIP LED RGB.W - CHIP 5050



Strip flessibile per illuminazione lineare; utilizza la tecnologia RGB.W per ottenere il meglio di una Strip RGB, senza rinunciare alla luce calda o naturale. Ciò è possibile grazie al 4° chip led installato sul prodotto che emette una luce 3000 o 4000 K.

*Flexible reel uses the RGB.W technology. It provides perfect RGB colors and a warm 3000 or 4000K lighting due to its 4th led chip installed.*

- Strip flessibile per illuminazione lineare con LED RGB multicolore, bobina da 5 metri.
- Sezionabile ad interassi prefissati ogni 10 cm
- Nastro adesivo 3M sul retro.
- La doppia intestazione dei cavi permette una connessione in serie più rapida.

- Flexible strip for linear lighting with multi chromatic RGB LEDs, 5-meter reel
- Cuttable on fixed point every 10 cm
- 3M sticker tape on the strip back
- Cables on both sides guarantee a faster in series connection



**Controller ed Accessori**  
Controller and Accessories  
pag. 187



Chip RGB.W con luce calda 3000K o luce naturale 4000K integrata  
RGB.W chip with integrated 3000K or 4000K color light

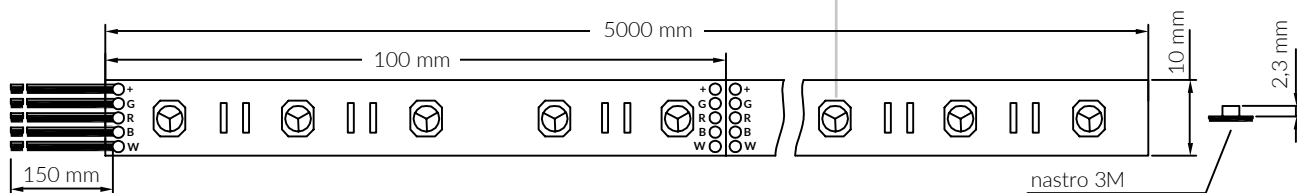

CODICE	IP	CONSUMO	W/MT	COLORE	LED/MT	LUMEN/MT	LUMEN	DC	LISTINO
SL72RGBW20	20	95 W	19	RGB.W 3000	60	1400	7000	24 V	100 €
SL72RGBW20/LBN	20	95 W	19	RGB.W 4000	60	1450	7250	24 V	100 €
SL72RGBW65	65	95 W	19	RGB.W 3000	60	1400	7000	24 V	110 €
SL72RGBW65/LBN	65	95 W	19	RGB.W 4000	60	1450	7250	24 V	110 €

**IP68**



Puoi trovare la versione IP68 a pag. 93  
You can find the IP68 version on page 93



# STRIP LED RGB DATI - CHIP 5050

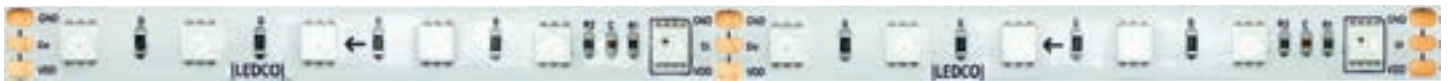

Strip flessibile per illuminazione lineare, utilizza la tecnologia BUS per poter controllare singolarmente i settori che compongono la strip led. I micro processori presenti sulla strip consentono un controllo del colore di ogni singolo tratto con la possibilità di creare giochi di luce unici.

*The flexible strip for linear illumination uses the BUS technology to control each led strip sector. The micro processors on the strip control the color of every part and can also create unique games of light.*

- Strip flessibile per illuminazione lineare con LED rgb multicromatico, bobina da 5 metri.
- Sezionabile ad interassi prefissati ogni 10 cm
- Nelle versioni IP65 utilizziamo un rivestimento protettivo in elastomero siliconico termo-dissipante con finitura diffondente (allunga la vita della strip all'esterno mantenendola trasparente e morbida nel tempo)
- Nastro adesivo 3M sul retro.
- La doppia intestazione dei cavi permette una connessione in serie più rapida.

- *The 5 meters flexible reel provides a linear multi chromatic LED lightning*
- *Cuttable on fixed point every 10 cm*
- *The IP65 version uses an silicon thermal-dissipating protective coating (extends the life of the strip on the outside, keeping it transparent and soft over time)*
- *3M sticker tape on the strip back*
- *Cables on both sides guarantee a faster in series connection*



**Controller ed Accessori**  
Controller and Accessories  
pag. 189



Scansionami e scopri di più sulle STRIP LED RGB DATI



Scan and find out more about rgb data led strips

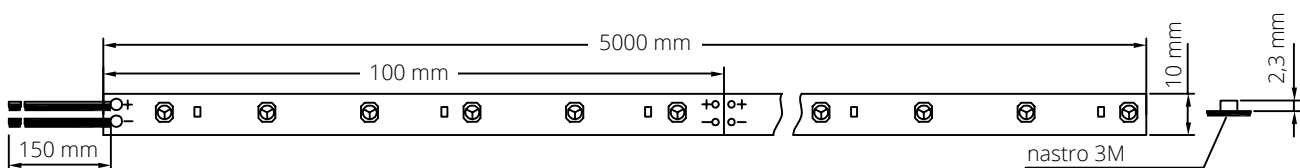

CODICE	IP	CONSUMO	W/MT	COLORE	LED/MT	LUMEN/MT	LUMEN	DC	LISTINO
SL72RGBD65	65	72 W	14,4 W	RGB	60	1080	5400	24 V	105 €





STRIP  
**RUNNER**



LED CO

# STRIP RUNNER - CHIP 2835

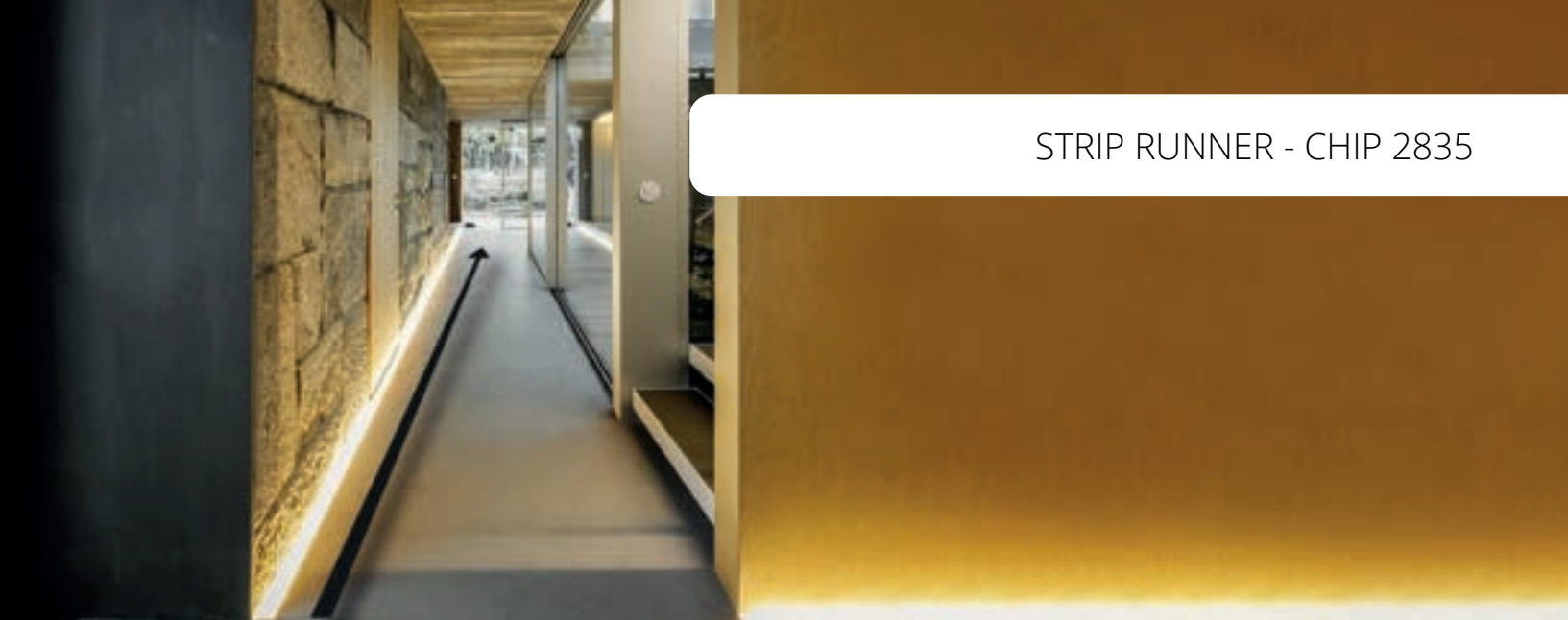

Strip flessibile per illuminazione lineare, utilizza la tecnologia BUS per poter controllare singolarmente i settori che compongono la strip led creando giochi di luce unici.

*The flexible strip for linear illumination uses the BUS technology to control each led strip sector creating unique game of light.*

- Strip LED monocromatica flessibile per illuminazione lineare, bobina da 5 metri.
- Sezionabile ad interassi prefissati ogni 12,5 cm
- Nastro adesivo 3M sul retro.
- La doppia intestazione dei cavi permette una connessione in serie più rapida.

- The 5-meter flexible reel provides a linear mono-chromatic LED lightning
- Cuttable on fixed point every 12,5 cm
- 3M sticker tape on the strip back
- Cables on both sides guarantee a faster in series connection

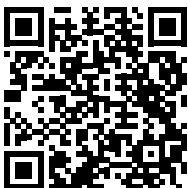

Scansionami e scopri di più sulla STRIP LED RUNNER



Scan and find out more about RUNNER led strip



## Controller e accessori

Controller and accessories

Controller CT610/P - 120 €  
Amplificatore CT420 - 55 €

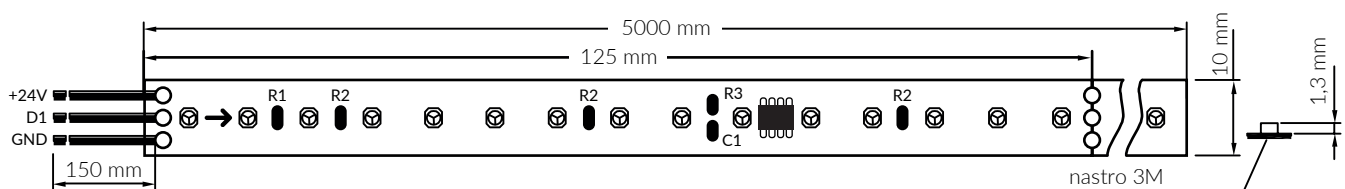

CODICE	IP	CONSUMO	W/MT	COLORE	LED/MT	LUMEN/MT	LUMEN	DC	LISTINO
SL120LBC20/R	20	60 W	12	3000 K	120	1900	9500	24 V	135 €
SL120LBN20/R	20	60 W	12	4000 K	120	1950	9750	24 V	135 €
SL120LBI20/R	20	60 W	12	6000 K	120	2020	10100	24 V	135 €







# STRIP LED FLEX

TUTTO QUELLO CHE PUOI IMMAGINARE

*EVERYTHING YOU CAN IMAGINE*

Prodotti customizzabili IP65, flessibili,  
con strip LED e lunghezza a scelta.

*Customizable products IP65, flexible,  
with LED strip and length of your choice.*







OCTOPUS è dotato di un' ottica con fascio d'apertura a 30° che garantisce uniformità luminosa e profondità di campo.

La coestrusione silconica e l'utilizzo delle PCB indipendenti tra loro, rendono possibile il movimento 3D del prodotto (curvabile sia sull'asse verticale che su quella orizzontale).

*OCTOPUS is equipped with an optical system with a 30 ° beam angle that guarantees light uniformity and depth of field.*

*The silicone coextrusion technique and the use of independent PCB boards, the 3D movement of the product is possible (bendable both on the vertical axis and on the horizontal axis).*

N.B. Affiancando più OCTOPUS la luce emessa sarà uniforme e non si formeranno zone d'ombra.  
P.S. By placing several OCTOPUS side by side, the light emitted will be uniform without shadow areas.

\*Dimensione tubo flex con aggiunta di tappo 29x23mm.

\*Flex tube size with the addition of end cap 29x23mm.

CODICE	IP	LUNGHEZZA	CONSUMO	W/MT	COLORE	LUMEN	LUMEN/MT	DC	LISTINO
OPT100LBH	65	1,00 MT	29 W	29	2700 K	1600	1600	24 V	270 €
OPT100LBC	65	1,00 MT	29 W	29	3000 K	1700	1700	24 V	270 €
OPT100LBN	65	1,00 MT	29 W	29	4000 K	1780	1780	24 V	270 €
OPT100RGB	65	1,00 MT	20 W	20	RGB	600	600	24 V	300 €
OPT250LBH	65	2,50 MT	72,5 W	29	2700 K	4000	1600	24 V	650 €
OPT250LBC	65	2,50 MT	72,5 W	29	3000 K	4250	1700	24 V	650 €
OPT250LBN	65	2,50 MT	72,5 W	29	4000 K	4450	1780	24 V	650 €
OPT250RGB	65	2,50 MT	50 W	20	RGB	1500	600	24 V	720 €
OPT500LBH	65	5,00 MT	145 W	29	2700 K	8000	1600	24 V	1300 €
OPT500LBC	65	5,00 MT	145 W	29	3000 K	8500	1700	24 V	1300 €
OPT500LBN	65	5,00 MT	145 W	29	4000 K	8900	1780	24 V	1300 €
OPT500RGB	65	5,00 MT	100 W	20	RGB	3000	600	24 V	1420 €

ACCESSORI - ACCESSORIES



**FL129 - 5 €**

Staffa fissa  
Fixed bracket

Dim. L 29 x H 27 mm



**FL129/X - 16 €**

Supporto orientabile  
Orientable support

\*Supporto da abbinare al Profilo FL129/1

\*Support to be combined with Profile FL129/1



**FL129/1 - 25 €**

Profilo da 1 metro  
1 meter profile

Dim. L 29 x H 27 mm



PER LA TUA CONFIGURAZIONE  
TI BASTERÀ SCEGLIERE:

FOR YOUR CONFIGURATION YOU JUST CHOOSE:



COLORE LED  
LED COLORED



LUNGHEZZA  
LENGHT



SUPPORTO  
SUPPORT

OCTOPUS ha la possibilità di curvare  
sia sull'asse verticale che su quella orizzontale.

*OCTOPUS has the ability to bend  
both on the vertical axis and on the horizontal  
one.*

OCTOPUS è dotato di un' ottica con fascio d'apertura a 30° che garantisce uniformità luminosa e profondità di campo.

La coestrusione silconica e l'utilizzo delle PCB indipendenti tra loro, rendono possibile il movimento 3D del prodotto (curvabile sia sull'asse verticale che su quella orizzontale).

*OCTOPUS is equipped with an optical system with a 30 ° beam angle that guarantees light uniformity and depth of field.*

*The silicone coextrusion technique and the use of independent PCB boards, the 3D movement of the product is possible (bendable both on the vertical axis and on the horizontal axis).*

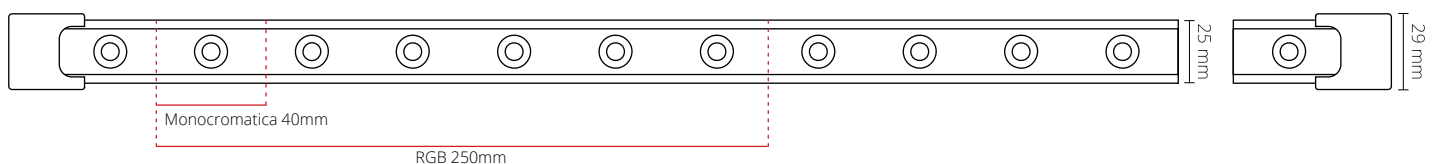

OCTOPUS CUSTOM Monocromatica sezionabile a multipli di 40mm.  
OCTOPUS CUSTOM RGB sezionabile a multipli di 250mm.

*Monochromatic OCTOPUS CUSTOM sectionable in multiples of 40mm.  
RGB OCTOPUS CUSTOM sectionable in multiples of 250mm.*

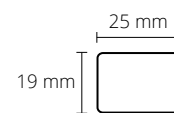

Dim. Corpo  
Body size

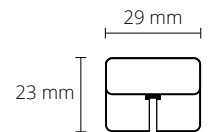

Cavo entra/esci da 50cm\*  
50cm cable at both/end\*

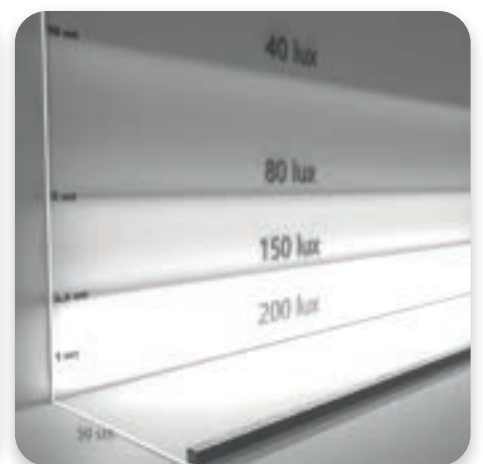
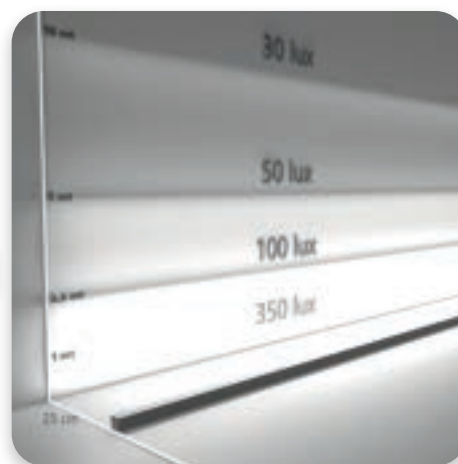
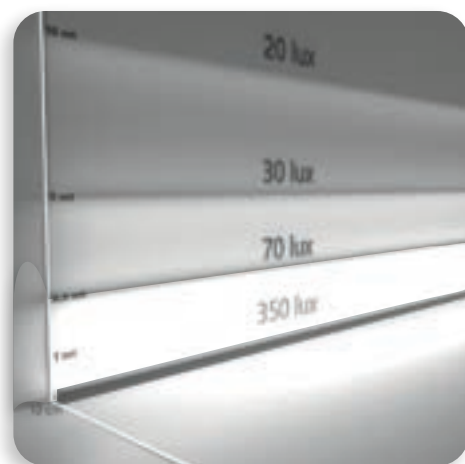

ACCESSORI - ACCESSORIES



**FL129 - 5 €**

Staffa fissa  
Fixed bracket

Dim. L 29 x H 27 mm



**FL129/X - 16 €**

Supporto orientabile  
Orientable support

\*Supporto da abbinare al Profilo FL129/1  
\*Support to be combined with Profile FL129/1



**FL129/1 - 25 €**

Profilo da 1 metro  
1 meter profile

Dim. L 29 x H 27 mm

# STRIP LED FLEX

TUTTO QUELLO CHE PUOI IMMAGINARE  
*EVERYTHING YOU CAN IMAGINE*

Prodotti customizzabili IP65, flessibili,  
con strip LED e lunghezza a scelta.

*Customizable products IP65, flexible,  
with LED strip and length of your choice.*

N.B. Il costo della lunghezza verrà calcolato in base al numero di centimetri in eccesso rispetto alla lunghezza indicata. (es. richiesta del cliente 9.60mt - prezzo calcolato per 10.00mt)

*P.S. The cost of the length will be calculated on the basis of the number of centimeters in excess of the indicated length. (e.g. customer request 9.60mt - price calculated for 10.00mt)*

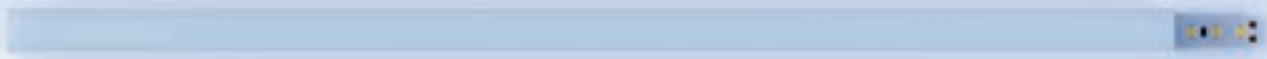

ip65

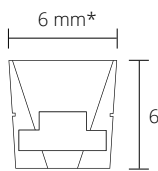

- Strip led flessibile miniaturizzata per illuminazione lineare da esterno o interno, lunghezza 5 mt. Dimensione tubo flex in silicone 6x6 mm\*
- Sezionabile ogni 4 cm;
- Per il fissaggio usare le staffe o il profilo, ordinabili separatamente;
- L'elevata densità dei LED consente un'illuminazione omogenea;
- Autodissipante;
- Diffusore opale.

- *Mini flex strip led for outdoor/indoor linear lighting, 5 meter length. 6x6 mm silicone flex tube size\**
- *Cuttable every 4 cm*
- *To install it you can use the hanging clips or the profile*
- *High LED density provides an uniform lightning on every surface*
- *Self-dissipating*
- *Opal screen*

**Tipologie di fissaggio**  
*Type of fixing*



**Con profilo PR113** - Profilo lineare 2mt  
*With profile PR113 - Aluminum profile 2mt*  
Per ulteriori dettagli e accessori  
vedi pag. 132  
*For more details and accessories  
see pag. 132*



**Con staffa**  
*With mounting plate*  
**FLM24CL - 1,20 €**  
Staffa fissaggio  
*Mounting plate*

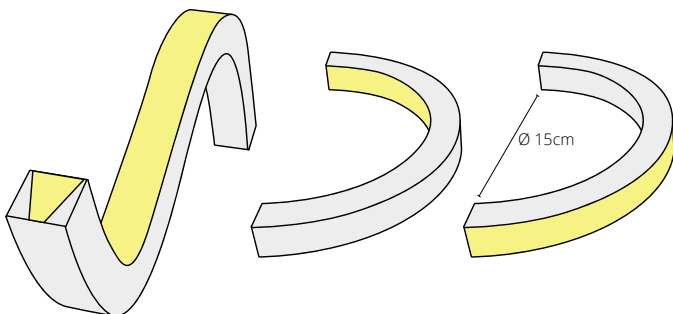

\*Dimensione tubo flex con aggiunta di tappo 7x7mm.  
\*Flex tube size with the addition of cap 7x7mm.

**ACCESSORI - ACCESSORIES**



**FLM24TA - 1 €**  
Tappo chiuso  
*Closed end Cap*



**FLM24TA/1 - 1 €**  
Tappo forato  
*End Cap with hole*

CODICE	IP	CONSUMO	W/MT	COLORE	LUMEN	LUMEN/MT	DC	LISTINO
FLM24LBC65	65	45 W	9 W	3000 K	3050	610	24 V	150 €
FLM24LBN65	65	45 W	9 W	4000 K	3150	630	24 V	150 €
FLM24LBI65	65	45 W	9 W	6000 K	3300	660	24 V	150 €



# STRIP LED FLEX 916

C U S T O M



**DOPPIA INTESTAZIONE - 25 €**  
Consigliato per lunghezze superiori a 5 mt (ad eccezione della serie 48V)

**DOUBLE HEADING - 25 €**  
Recommended for lengths over 5 m (except 48V series)



ip65

La strip LED FLEX CUSTOM ti permette di scegliere la tipologia di strip con le caratteristiche più adatte alle tue esigenze, ricevendo direttamente il prodotto finito pronto per l'installazione. Lunghezza massima 20 mt. IP 65. Prodotto autodissipante.

The **CUSTOM FLEX LED STRIP** allows you to choose the type of strip with the features that suit your needs best, directly receiving the final product ready for installation. Maximum length 20 meters. IP 65. The fixture can dissipate the heat by itself.

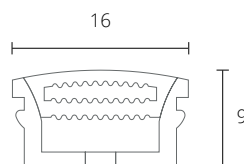

**FL916**  
Tubo vuoto flex 9x15 mm silicone  
Empty flex tube 9x15mm silicone

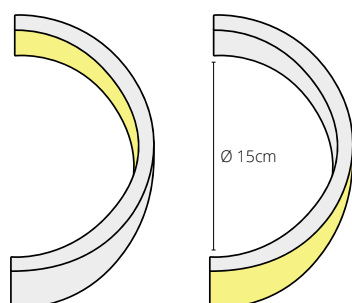
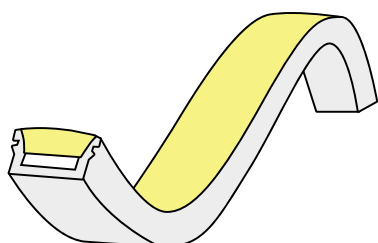

① **Scegli la strip compatibile**  
più adatta alle tue esigenze  
**Choose the compatible strip suits your needs best**



CODICE	W/MT	LISTINO
COB - SLC30ES	6 W	€ 65
SL60	12 W	€ 55
SL120	16 W	€ 55
SL120ES	8 W	€ 55
SL180	14,4 W	€ 65
SL200ES	12 W	€ 65
RGB	14,4 W	€ 65
RGB.W	19 W	€ 65
MONOCR.	12 W	€ 65
BIANCO D.	16 W	€ 65
48 VOLT	8 W	€ 70

\*Completo di tappi e cavo di alimentazione  
\*Complete with plugs and power cord

② **Scegli la tipologia di fissaggio**  
**Choose the type of fixing**

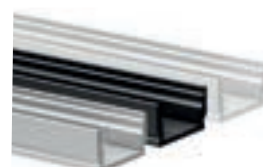

**Con profilo PR115**  
Profilo lineare 2mt / 3mt  
With aluminum profile 2mt / 3 mt

Per ulteriori dettagli  
vedi pag. 124  
For more details  
see pag. 124



**Con staffa EN916 - 1,30 €**  
Staffa fissaggio  
With metal holder

## ACCESSORI - ACCESSORIES



**FL916TA - 1,00 €**  
Tappo a filo chiuso  
Levelled closed end cap



**FL916TA/1 - 1,00 €**  
Tappo a filo forato  
Levelled end cap with hole





**DOPPIA INTESTAZIONE - 25 €**  
 Consigliato per lunghezze superiori a 5 mt  
 (ad eccezione della serie 48V)

**DOUBLE HEADING - 25 €**  
 Recommended for lengths over 5 m  
 (except 48V series)



ip65

La strip LED FLEX CUSTOM ti permette di scegliere la tipologia di strip con le caratteristiche più adatte alle tue esigenze, ricevendo direttamente il prodotto finito pronto per l'installazione. Lunghezza massima 20 mt. IP 65. Autodissipante.

*The CUSTOM FLEX LED STRIP allows you to choose the type of strip with the features that best suit your needs, directly receiving the finished product ready for installation. Maximum length 20 meters. IP 65. Self-dissipating.*

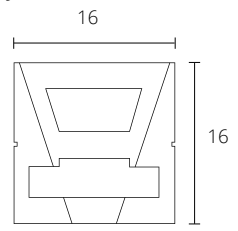

**FL1616**  
 Tubo vuoto flex 16x16mm silicone.  
 Dimensioni con aggiunta di tappo  
 18x18mm\* Empty flex tube 16x16mm  
 silicone  
 Size with the addition of cap 18x18mm\*

1 Scegli la strip compatibile  
 più adatta alle tue esigenze  
**Choose the compatible strip**  
 that best suits your needs



CODICE	W/MT	LISTINO
COB - SLC30ES	6 W	€ 65
SL60	12 W	€ 55
SL120	16 W	€ 55
SL120ES	8 W	€ 55
SL180	14,4 W	€ 60
SL200ES	12 W	€ 60
RGB	14,4 W	€ 60
RGB.W	19 W	€ 60
MONOCR.	12 W	€ 60
BIANCO D.	16 W	€ 60
48 VOLT	8 W	€ 70

\*Completo di tappi e cavo di alimentazione  
 \*Complete with plugs and power cord

2 Scegli la tipologia di fissaggio  
**Choose the type of fixing**



**Con profilo PR120**  
 Profilo lineare 2mt  
 Aluminum profile 2mt  
 Per ulteriori dettagli  
 vedi pag. 127  
 For more details  
 see pag. 127



**Con staffa FL1616CL - 1,30 €**  
 Staffa fissaggio  
 With mounting plate

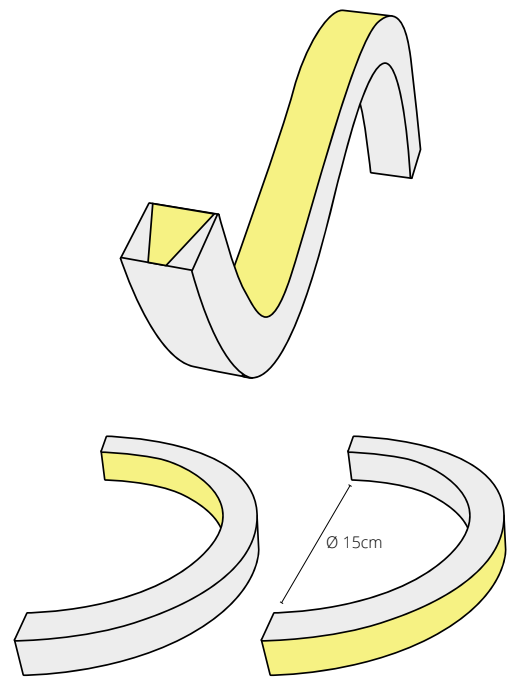

ACCESSORI - ACCESSORIES



**FL1616TA - 1,00 €**  
 Tappo chiuso  
 Closed end Cap



**FL1616TA/1 - 1,00 €**  
 Tappo forato  
 End Cap with hole



**FL1616TA/1L - 1,00 €**  
 Tappo con foro laterale  
 End Cap with side hole

\*Su richiesta sono disponibili i tappi a filo.  
 Tappo a filo chiuso FL1616TF  
 Tappo a filo forato FL1616TF/1  
 \*Levelled end caps available on request.  
 Levelled closed end cap FL1616TF  
 Levelled end cap with hole FL1616TF/1

# STRIP LED FLEX 612

C U S T O M

**DOPPIA INTESTAZIONE - 25 €**  
 Consigliato per lunghezze superiori a 5 mt  
 (ad eccezione della serie 48V)

**DOUBLE HEADING - 25 €**  
 Recommended for lengths over 5 m  
 (except 48V series)

La strip LED FLEX CUSTOM ti permette di scegliere la lunghezza desiderata ricevendo il prodotto finito pronto per l'installazione. Lunghezza massima 10 mt, con doppia alimentazione. IP 65. Prodotto autodissipante.

*The CUSTOM FLEX LED STRIP allows you to choose the desired length by receiving the finished product ready for installation. Maximum length 10 meters, with double power supply. IP 65. Self-dissipating product.*

ip65

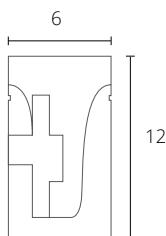
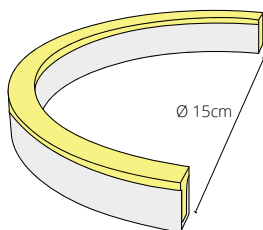
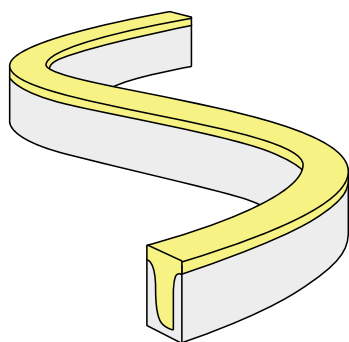

### FL612

Tubo vuoto flex 6x12 mm silicone  
 Dimensioni con aggiunta di tappo 8x14mm.  
*Empty flex tube 6x12mm silicone  
 Size with the addition of cap 8x14mm*

### Strip compatibile Compatible strip



CODICE W/MT LISTINO

SL125 16 W € 50

\*Completo di tappi e cavo di alimentazione  
 \*Complete with plugs and power cord

### FL612CL - 1,00 €

Staffa fissaggio  
 Mounting plate



### ACCESSORI - ACCESSORIES



**FL612TA - 1,00 €**  
 Tappo chiuso  
 Closed end Cap



**FL612TA/1 - 1,00 €**  
 Tappo forato  
 End Cap with hole

**DOPPIA INTESTAZIONE - 25 €**

Consigliato per lunghezze superiori a 5 mt  
(ad eccezione della serie 48V)

**DOUBLE HEADING - 25 €**

Recommended for lengths over 5 m  
(except 48V series)

La strip LED FLEX CUSTOM ti permette di scegliere la tipologia di strip con le caratteristiche più adatte alle tue esigenze, ricevendo direttamente il prodotto finito pronto per l'installazione. Lunghezza massima 20 mt. IP 65. Autodissipante.  
*The CUSTOM FLEX LED STRIP allows you to choose the type of strip with the features that best suit your needs, directly receiving the finished product ready for installation. Maximum length 20 meters. IP 65. Self-dissipating.*

ip65

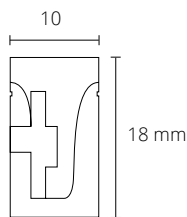
**FL1018**

Tubo vuoto flex 10x18mm silicone.  
Dimensioni con aggiunta di tappo 12x20mm.  
*Empty flex tube 10x18mm silicone  
Size with the addition of cap 12x20mm*

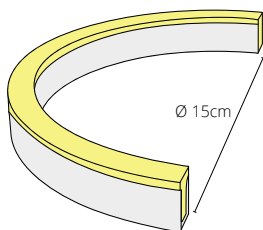
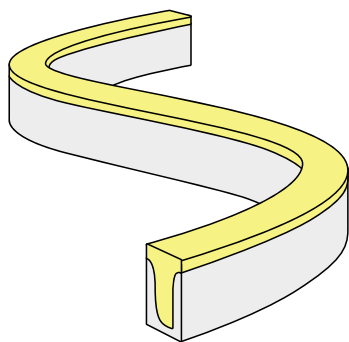

- ① **Scegli la strip compatibile**  
più adatta alle tue esigenze  
**Choose the compatible strip**  
that best suits your needs



CODICE	W/MT	LISTINO
COB - SLC30ES	6 W	€ 65
SL60	12 W	€ 55
SL120	16 W	€ 55
SL120ES	8 W	€ 55
SL180	14,4 W	€ 65
SL200ES	12 W	€ 65
RGB	14,4 W	€ 65
RGB.W	19 W	€ 65
MONOCR.	12 W	€ 65
BIANCO D.	16 W	€ 65
48 VOLT	8 W	€ 70

\*Completo di tappi e cavo di alimentazione  
\*Complete with plugs and power cord

- ② **Scegli la tipologia di fissaggio**  
**Choose the type of fixing**

**Con profilo FL220CL2 - 22,50 €**

Profilo lineare 2mt  
With aluminum profile 2mt

**Con staffa FL220CL - 1,20 €**

Staffa fissaggio  
With Mounting plate

## ACCESSORI - ACCESSORIES

**FL1018TA - 1,00 €**

Tappo chiuso  
Closed end Cap

**FL1018TA/1 - 1,00 €**

Tappo forato  
End Cap with hole

**FL1018TA/1L - 1,00 €**

Tappo con foro laterale  
End Cap with side hole



---

# PROFILI

## IN ALLUMINIO

---

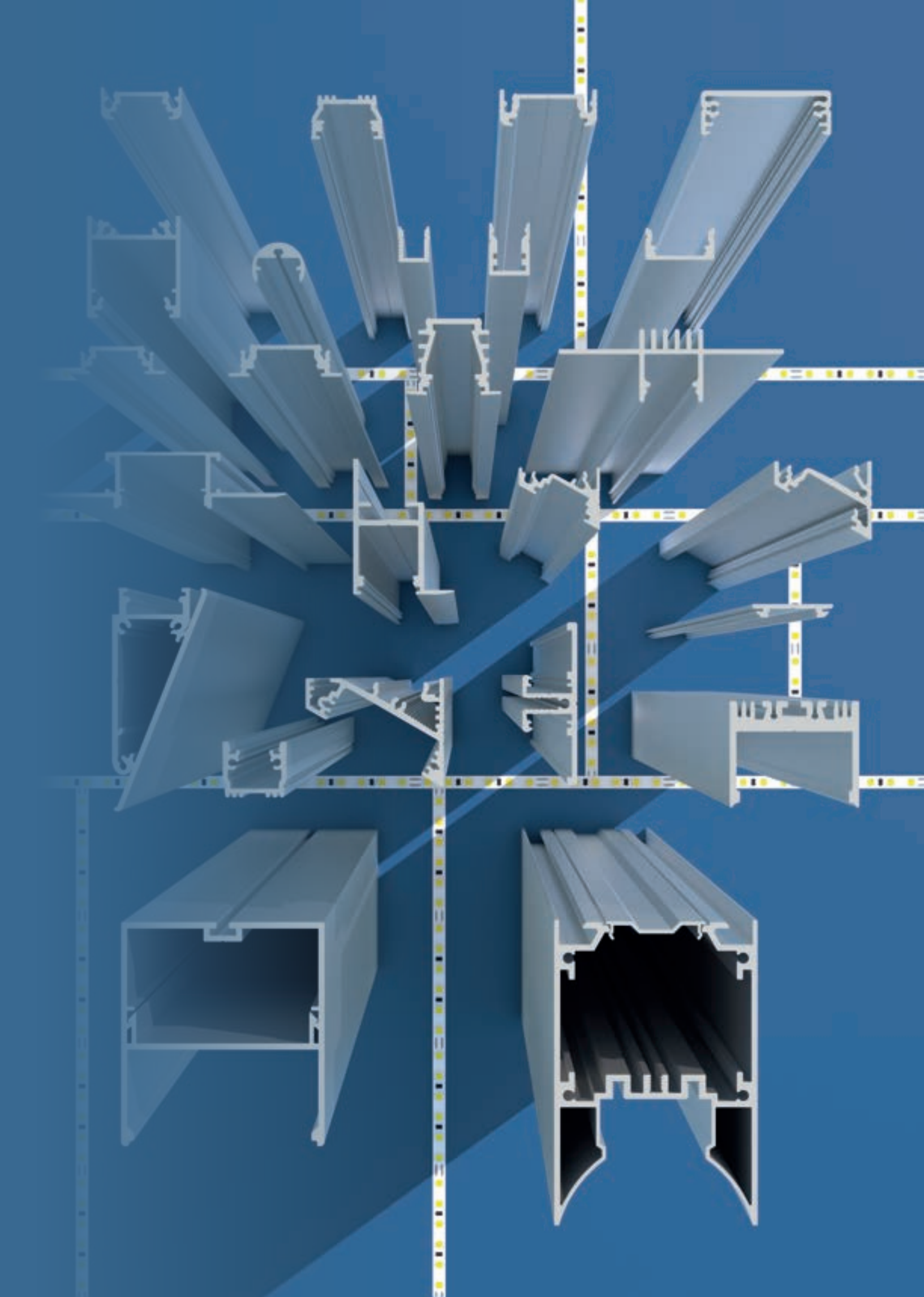



# Tabella compatibilità strip LED e profili in alluminio

Compatibility table LED strip and aluminum profiles

		PROFILI IN ALLUMINIO DA SUPERFICIE													
		pag. 122	pag. 121	pag. 124	pag. 125	pag. 126	pag. 125	pag. 127	pag. 127	pag. 128	pag. 129	pag. 130	pag. 131	pag. 132	pag. 133
MONOCROMATICHE	SLP220			●●●		—	●●●		—	—		—			
	SL500			—		—	—	—	—	—		—			
	SL200 SL200/ES	—	—	—	—	—	—	—	—	—	—	—			—
	SL200CRI97+			—	—	—	—	—	—	—		—			
	SL180	●●●	—	—	—	—	—	—	—	—		—			—
	SL125	●●●	●●●	●●●	—	—	●●●	●●●	—	—	●●●	—	—	—	●●●
	SL120 SL120/ES SL120/48	●●●	●●●	●●●	—	—	●●●	●●●	—	—	●●●	—			●●●
	SL60	●●●	●●●	●●●	●●●	—	●●●	●●●	—	—	●●●	—			●●●
	SL24	●●●	●●●	●●●	●●●	—	●●●	●●●	—	—	●●●	—			●●●
	COB SLC50	—	—	—	—	—	—	—	—	—	—	—			—
COB SLC30ES	—	—	—	—	—	—	—	—	—	—	—			—	
FOOD - BD - WAVY	SL120MT65 SL120GD65 SL120FH65	●●●	●●●	●●●	●●●	—	●●●	●●●	—	—	●●●	—			●●●
	SL120BD20	●●●	●●●	●●●	●●●	—	●●●	●●●	—	—	●●●	—			●●●
	WAVY	●●●	●●●	●●●	●●●	—	●●●	●●●	—	—	●●●	—			●●●
IP68	SL125LB68			●●●	●●●	—			—	—		—			
	SL72RGB68			●●●		—			—	—		—			
	SL120LB68/48			●●●		—			—	—		—			
	SL184LBG65			●●●		—			—	—		—			
COLORI	ROSSO BLU VERDE	●●●	●●●	●●●	—	—	●●●	●●●	—	—	●●●	—			●●●
	RGB RGB.W RGB.DATI	●●●	●●●	●●●	●●●	—	●●●	●●●	—	—	●●●	—			●●●
RUNNER	STRIP RUNNER	●●●	●●●	●●●	—	—	●●●	●●●	—	—	●●●	—			●●●



# Tabella compatibilità strip LED e profili in alluminio

Compatibility table LED strip and aluminum profiles

PROFILI IN ALLUMINIO AD INCASSO						SERIE LINE IN			INCASSO A SCOMPARSA				PROFILI ANGOLARI		
DWG 134	DWG 135	DWG 137	DWG 138	DWG 138	DWG 139	DWG 159	DWG 160	DWG 162	DWG 141	DWG 142	DWG 143	DWG 144	DWG 146	DWG 147	DWG 140
—					—						—	—			—
—			—		—				—	—	—	—		—	—
—		—	—	—	—		—		—	—	—	—	—	—	—
—				—	—				—	—	—	—	—	—	—
—		—	—	—	—		—		—	—	—	—	—	—	—
—		...	...	—	—	—	...		...	...	—	—	...	...	—
—		...	...	—	—		...		—	—	—	—	...	...	—
...		...	...	—	—		...		...	...	...	—	...	...	—
...		...	...	—	—		...		...	...	...	—	...	...	—
—		—	—	—	—		—		—	—	—	—	—	—	—
—		—	—	—	—		—		—	—	—	—	—	—	—
—		...	...	—	—		...		...	...	—	—	...	...	—
—		...	...	—	—		...		...	...	—	—	...	...	—
—		...	...	—	—		...		...	...	—	—	...	...	—
—		...	...	—	—		...		—	—	—	—	...	...	—
—		...	...	—	—		...		—	—	—	—	...	...	—
—		...	...	—	—		...		—	—	—	—	...	...	—

MONOCROMATICHE

FOOD - BD - WAVY

IP68

COLORI

RUNNER



# Tabella compatibilità strip LED e profili in alluminio

Compatibility table LED strip and aluminum profiles

	Effetto Puntinato Effetto Luce Continua	PROFILI IN ALLUMINIO A SOSPENSIONE						DA PARETE		BANDELLE	
		pag. 145	pag. 146	pag. 149	pag. 150	pag. 150	pag. 151/152	pag. 154	pag. 155	pag. 156/157	pag. 157
MONOCROMATICHE	SLP220	—	—	—	—	—					
	SL500	—	—	—	—	—	—				
	SL200 SL200/ES	—	—	—	—	—	—	—	—		
	SL200CRI97+	—	—	—	—	—	—	—			
	SL180	—	—	—	—	—	—	—	—		
	SL125	—	—	—	—	—	—	—	●●●		
	SL120 SL120/ES SL120/48	—	—	—	—	—	—	—	●●●	●●● SL120/ES SL120/48	
	SL60	—	—	—	—	—	—	—	●●●	●●●	
	SL24	—	—	—	—	—	—	—	●●●	●●●	
	COB SLC50	—	—	—	—	—	—	—	—	—	
COB SLC30ES	—	—	—	—	—	—	—	—	—		
FOOD - BD - WAVY	SL120MT65 SL120GD65 SL120FH65	—	—	—	—	—	—	—	●●●		
	SL120BD20	—	—	—	—	—	—	—	●●●		
	WAVY	—	—	—	—	—	—	—	●●●	●●●	
IP68	SL125LB68	—	—	—	—	—	—	—	●●●		
	SL72RGB68	—	—	—	—	—	—				
	SL120LB68/48	—	—	—	—	—	—				
	SL184LBG65	—	—	—	—	—	—				
COLORI	ROSSO BLU VERDE	—	—	—	—	—	—	—	●●●	●●●	
	RGB RGB.W RGB.DATI	—	—	—	—	—	—	—	●●●		
	STRIP RUNNER	—	—	—	—	—	—	—	●●●		



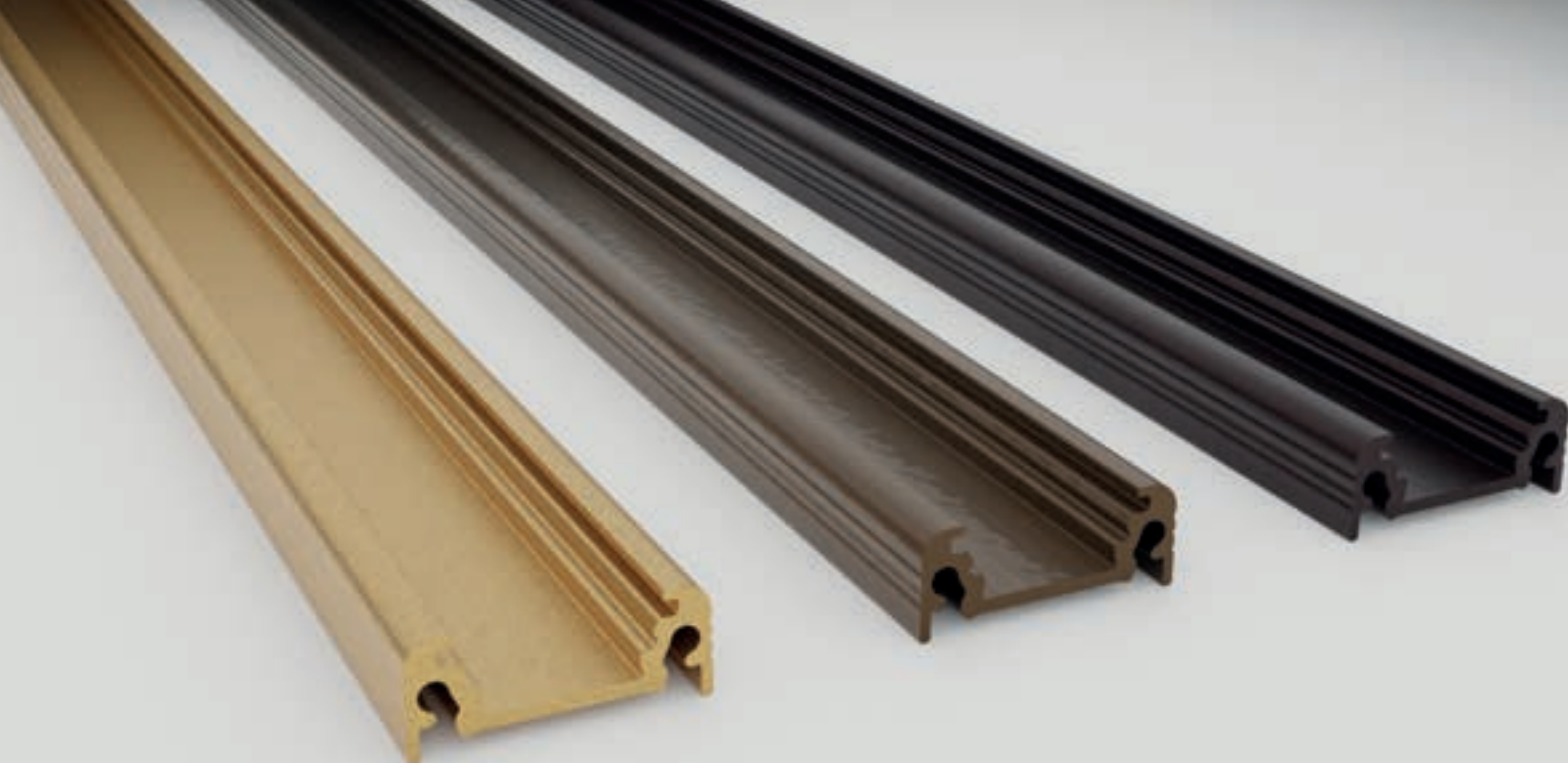

## PROFILI SPECIAL: 3 NUOVI COLORI PER I TUOI PROGETTI

Le nuove ossidazioni customizzate completano la gamma di colori disponibili, adattandosi ad ogni esigenza progettuale.

### *SPECIAL PROFILES: 3 NEW COLORS FOR YOUR PROJECTS*

*The new customized oxidations completes the range of colors available, adapting to every design requirement.*

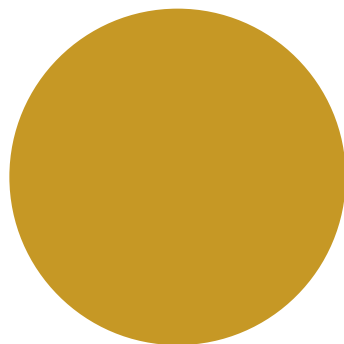

Oro - *Gold*  
RAL Gold Eco

Ottone - *Brass*  
RAL 1035

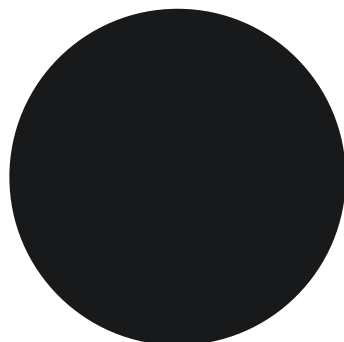
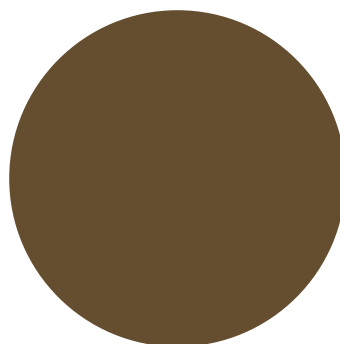

Testa di moro - *Dark brown*  
RAL 8019 Opaco

PROFILO IN ALLUMINIO  
PER SUPERFICI PIANE  
ALUMINUM PROFILES FOR SURFACE



## PR101

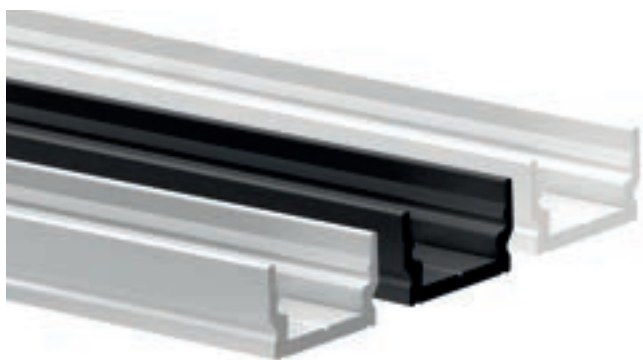

CODICE	LUNGHEZZA	COLORE	LISTINO
PR101	2 MT	Silver	19 €
PR101/NE	2 MT	Nero	22,50 €
PR101/BI	2 MT	Bianco	22,50 €
PR101/3	3 MT	Silver	30,50 €
PR101/3NE	3 MT	Nero	34 €
PR101/3BI	3 MT	Bianco	34 €

Confezioni da 10pz | Packs of 10pcs

**Può dissipare fino a 20 w/mt** ... Elimina l'effetto puntinato (vedi pag. 118)  
Power dissipation up to 20 w/mt ... Eliminate the dotted effect (see page 118)

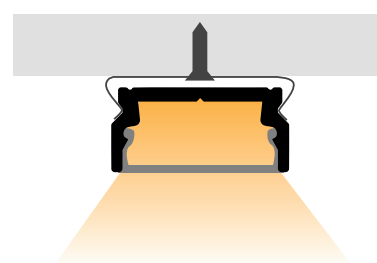
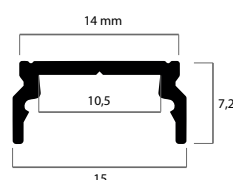

### ACCESSORI - ACCESSORIES



**EN000** - € 1,00  
Staffa per profilo  
Flexible mounting plate



**EN111** - € 1,00  
Tappo chiuso grigio  
Gray closed end cap  
**EN111/NE** - Nero / Black  
**EN111/BI** - Bianco / White



**EN111/1** - € 1,00  
Tappo forato grigio  
Gray end cap with hole  
**EN111/1/NE** - Nero / Black  
**EN111/1/BI** - Bianco / White



**PR910** - € 10,5  
Schermo opaco 2 mt  
White cover 2 mt  
**PR910/3** - € 17  
3 mt  
**PR910/10** - € 55  
10 mt



**PR900** - € 9,00  
Schermo trasparente 2 mt  
Transparent cover 2 mt  
**PR900/3** - € 13  
Schermo trasparente 3 mt  
Transparent cover 3 mt



**PR910/NE** - € 17  
Schermo nero 2 mt  
Black cover 2 mt

PROFILO IN ALLUMINIO  
PER SUPERFICI PIANE  
ALUMINUM PROFILES FOR SURFACE

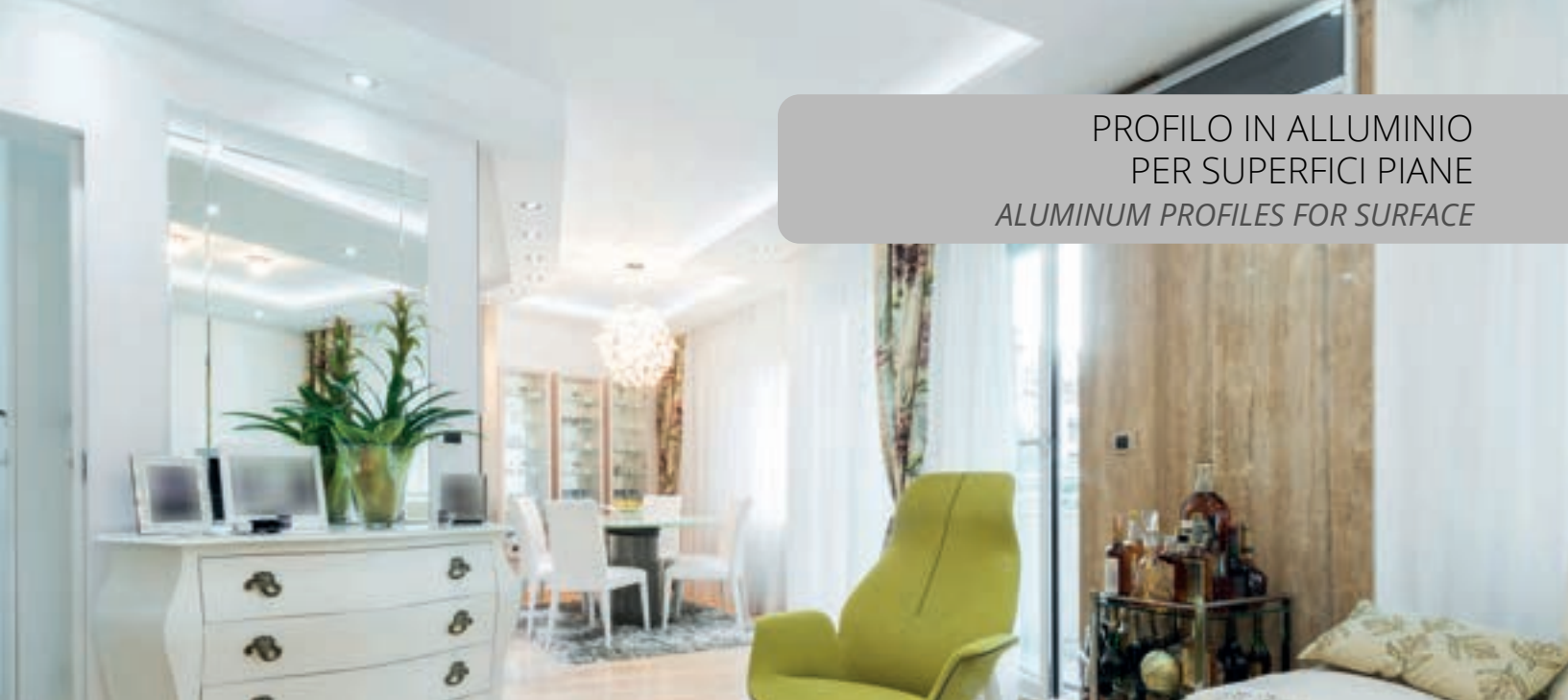

PR100

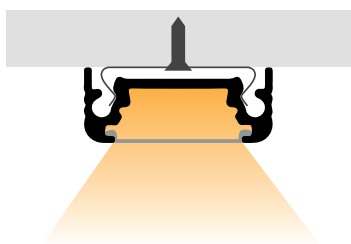
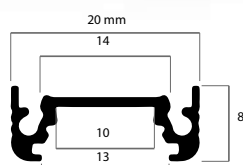

CODICE	LUNGHEZZA	COLORE	LISTINO
PR100	2 MT	Silver	20 €
PR100/NE	2 MT	Nero	23,50 €
PR100/BI	2 MT	Bianco	23,50 €
PR100/3	3 MT	Silver	32 €
PR100/3NE	3 MT	Nero	36 €
PR100/3BI	3 MT	Bianco	36 €

Confezioni da 10pz | Packs of 10pcs

COLORI SPECIAL

● PR100/TDM	2 MT	Testa di Moro Dark Brown	41 €
● PR100/OTN	2 MT	Ottone Brass	41 €
● PR100/ORO	2 MT	Oro Gold	41 €

Codici RAL pag. 121 - RAL code pag.121

**Può dissipare fino a 20 w/mt** Elimina l'effetto puntinato (vedi pag. 118)  
Power dissipation up to 20 w/mt *Eliminate the dotted effect (see page 118)*

ACCESSORI - ACCESSORIES



**EN000** - € 1  
Staffa per profilo  
Flexible mounting plate



**EN100** - € 1,00  
Tappo chiuso grigio  
Gray closed end cap  
**EN100/NE** - Nero / Black  
**EN100/BI** - Bianco / White



**EN101** - € 1,00  
Tappo forato grigio  
Gray end cap with hole  
**EN101/NE** - Nero / Black  
**EN101/BI** - Bianco / White



**PR910** - € 10,5  
Schermo opaco 2 metri  
White cover 2 mt  
**PR910/3** - € 17  
3 metri  
**PR910/10** - € 55  
10 metri

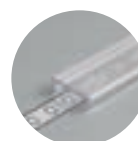

**PR900** - € 9,00  
Schermo trasparente 2 mt  
Transparent cover 2 mt  
**PR900/3** - € 13  
Schermo trasparente 3 mt  
Transparent cover 3 mt



**PR910/NE** - € 17  
Schermo nero 2 mt  
Black cover 2 mt

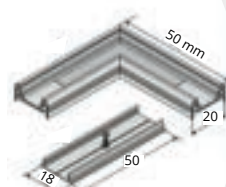

Connettore angolo 90° per  
profilo di superficie PR100,  
completo di staffe per il fissaggio.  
90° connector for PR100 surfaces  
with attachment brackets.

CODICE	COLORE	LISTINO
CO100	Silver	20 €
CO100/BI	Bianco	26 €
CO100/NE	Nero	26 €

PROFILO IN ALLUMINIO  
PER SUPERFICI PIANE  
ALUMINUM PROFILES FOR SURFACE



**PR115**

Profilo in alluminio anodizzato per installazione su superfici piane *Aluminum profile for flat surfaces*

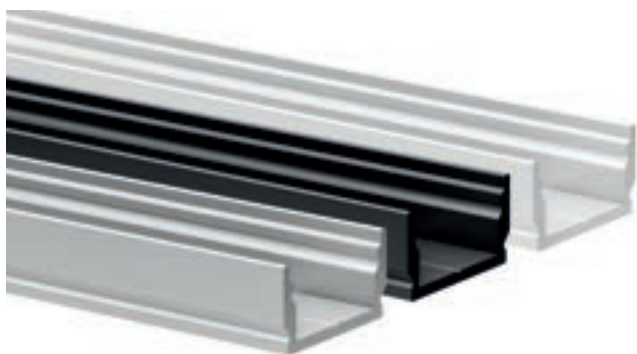

CODICE	LUNGHEZZA	COLORE	LISTINO
PR115	2 MT	Silver	22,50 €
PR115/NE	2 MT	Nero	25,50 €
PR115/BI	2 MT	Bianco	25,50 €
PR115/3	3 MT	Silver	36 €
PR115/3NE	3 MT	Nero	40,50 €
PR115/3BI	3 MT	Bianco	40,50 €

Confezioni da 10pz | Packs of 10pcs

**Può dissipare fino a 30 w/mt** ☹️ Elimina l'effetto puntinato (vedi pag. 118)  
*Power dissipation up to 30 w/mt* Eliminate the dotted effect (see page 118)

Su questo profilo è possibile installare la strip SLP220 (vedi pagina 48)  
*The SLP220 strip LED can be installed on this profile (see page 48)*

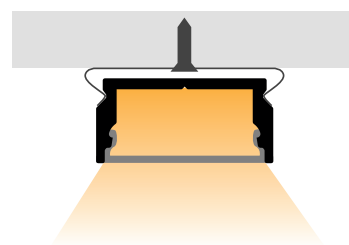
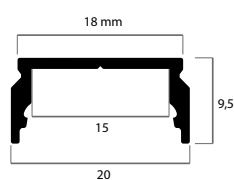

ACCESSORI - ACCESSORIES



**EN014** - € 1,50  
Staffa per profilo  
*Flexible mounting plate*



**EN115** - € 1,00  
Tappo chiuso  
*Closed end cap*  
**EN115/NE** - Nero / Black  
**EN115/BI** - Bianco / White



**EN115/1** - € 1,00  
Tappo forato  
*End cap with hole*  
**EN115/1/NE** - Nero / Black  
**EN115/1/BI** - Bianco / White



**PR911** - € 22  
Schermo opaco 2 mt  
*White cover 2 mt*  
**PR911/3** - € 33  
Schermo opaco 3 mt  
**PR911/10** - € 110  
Schermo opaco 10 mt



**PR901** - € 20  
Schermo trasparente 2 mt  
*Transparent cover 2 mt*  
**PR901/3** - € 30  
Schermo trasparente 3 mt  
*Transparent cover 3 mt*



**PR911/NE** - € 23,50  
Schermo nero 2 mt  
*Black cover 2 mt*



**PR911 F** - € 32  
Schermo opaco 2 mt calpestabile  
*Walkable white cover 2 mt*

PROFILO IN ALLUMINIO  
PER SUPERFICI PIANE  
ALUMINUM PROFILES FOR SURFACE

PR500



CODICE	LUNGHEZZA	COLORE	LISTINO
PR500	2 MT	Silver	23 €
PR500/BI	2 MT	Bianco	26 €
PR500/NE	2 MT	Nero	26 €

**Può dissipare fino a 30w/mt** Elimina l'effetto puntinato (vedi pag. 118)  
Power dissipation up to 30 w/mt *Eliminate the dotted effect (see page 118)*

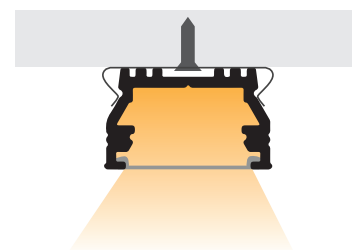
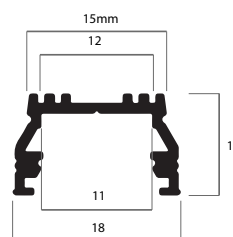

ACCESSORI - ACCESSORIES



**EN000** - € 1  
Staffa per profilo  
*Flexible mounting plate*



**EN500** - € 1  
Tappo chiuso grigio  
*Gray closed end cap*  
**EN500/NE** - Nero / Black  
**EN500/BI** - Bianco / White



**EN501** - € 1  
Tappo forato grigio  
*Gray end cap with hole*  
**EN501/NE** - Nero / Black  
**EN501/BI** - Bianco / White



**PR910** - € 10,5  
Schermo opaco 2 mt  
*White cover 2 mt*  
**PR910/3** - € 16  
3 mt  
**PR910/10** - € 55  
10 mt

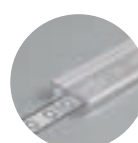

**PR900** - € 9  
Schermo trasparente 2 mt  
*Transparent cover 2 mt*  
**PR900/3** - € 13  
Schermo trasparente 3 mt  
*Transparent cover 3 mt*



**PR910/NE** - € 17  
Schermo nero 2 mt  
*Black cover 2 mt*

## PR561

Profili in alluminio anodizzato per installazione su superfici piane

Aluminum profiles for surface



CODICE	LUNGHEZZA	COLORE	LISTINO
PR561/NE	2 MT	Nero	37 €
PR561/BI	2 MT	Bianco	37 €

**Può dissipare fino a 30 w/mt**  
Power dissipation up to 30 w/mt

... Elimina l'effetto puntinato (vedi pag. 118)  
Eliminate the dotted effect (see page 118)

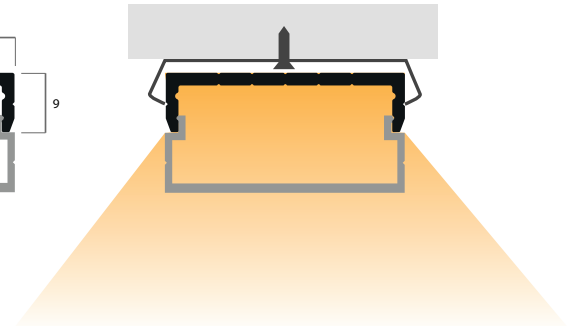
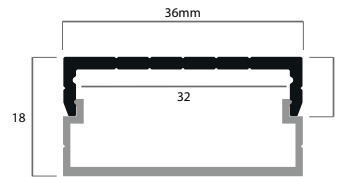

### ACCESSORI - ACCESSORIES



**EN061** - € 1,50  
Staffa per profilo  
Flexible mounting plate



**EN561/NE** - € 1,50  
Tappo nero  
Black end cap  
**EN561/BI** -  
Tappo bianco  
White end cap



**PR960** - € 23,50  
Schermo opaco 2 mt  
White cover 2 mt

## PR130



CODICE	LUNGHEZZA	COLORE	LISTINO
PR130	2 MT	Silver	37 €

**Può dissipare fino a 40 w/mt**  
Power dissipation up to 40 w/mt

... Elimina l'effetto puntinato (vedi pag. 118)  
Eliminate the dotted effect (see page 118)

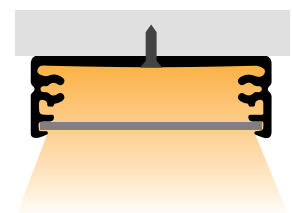
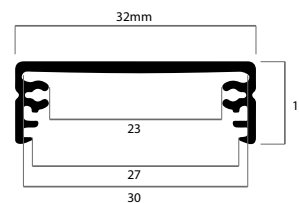

### ACCESSORI - ACCESSORIES



**EN030** - € 2,50  
Staffa per profilo PR130  
Flexible mounting plate  
for PR130



**EN130** - € 1  
Tappo chiuso  
Closed end cap



**EN130/1** - € 1  
Tappo forato  
End cap with hole

SCHERMI A SLITTA

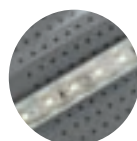

**PR830** - € 6,50  
Schermo trasparente 2 mt  
Transparent cover 2 mt



**PR831** - € 7,50  
Schermo opaco 2 mt  
White cover 2 mt

CODICE	LUNGHEZZA	COLORE	LISTINO
PR114	2 MT	Silver	24,50 €

**Può dissipare fino a 30 w/mt**  Elimina l'effetto puntinato (vedi pag. 118)  
 Power dissipation up to 30 w/mt *Eliminate the dotted effect (see page 118)*

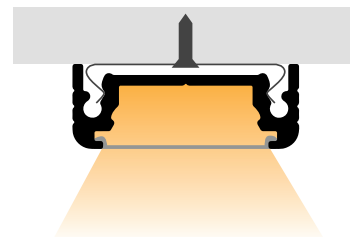
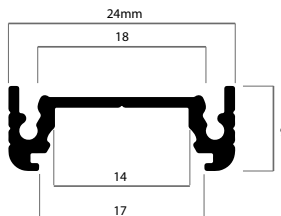

**ACCESSORI - ACCESSORIES**



**EN014** - € 1,50  
 Staffa per profilo PR114  
*Flexible mounting plate for PR114*



**EN114** - € 1  
 Tappo chiuso  
*Closed end cap*



**EN114/1** - € 1  
 Tappo forato  
*End cap with hole*



**PR911** - € 22  
 Schermo opaco 2 mt  
*White cover 2 mt*  
**PR911/3** - € 33  
 Schermo opaco 3 mt  
**PR911/10** - € 110  
 Schermo opaco 10 mt



**PR901** - € 20  
 Schermo trasparente 2 mt  
*Transparent cover 2 mt*  
**PR901/3** - € 30  
 Schermo trasparente 3 mt  
*Transparent cover 3 mt*



**PR911/NE** - € 23,50  
 Schermo nero 2 mt  
*Black cover 2 mt*

**PR120**

CODICE	LUNGHEZZA	COLORE	LISTINO
PR120	2 MT	Silver	€ 30
PR120/BI	2 MT	Bianco	€ 42,50
PR120/NE	2 MT	Nero	€ 44,50

**Può dissipare fino a 40 w/mt**  Elimina l'effetto puntinato (vedi pag. 118)  
 Power dissipation up to 40 w/mt *Eliminate the dotted effect (see page 118)*

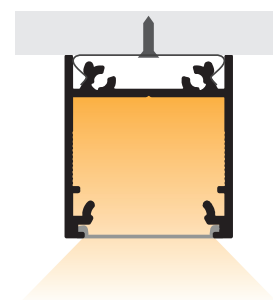
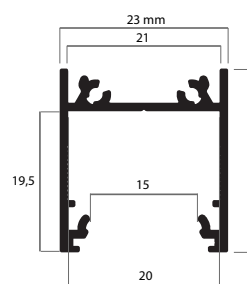
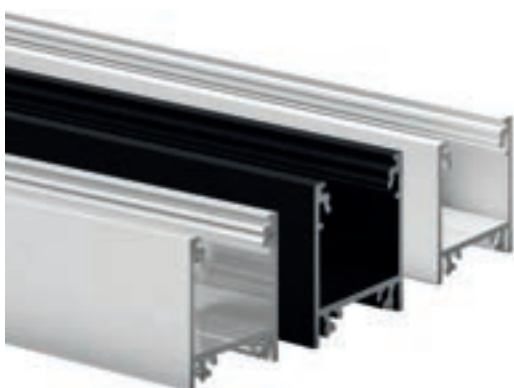

**COLORI SU RICHIESTA - ON REQUEST COLORS**

Ordine minimo 15pz | *Minimum order 15pcs*

-  oro *gold*
-  testa di moro *dark brown*
-  ottone *brass*

**ACCESSORI - ACCESSORIES**



**EN014** - € 1,50  
 Staffa per profilo PR120  
*Flexible mounting plate for PR120*



**EN120** - € 1,50  
 Tappo chiuso - silver  
*Closed end cap silver*  
**EN120/NE** - Nero / *Black*  
**EN120/BI** - Bianco / *White*



**CO120X** - € 10  
 Giunzione lineare  
*Linear joint*



**PR911** - € 22  
 Schermo opaco 2 mt  
*White cover 2 mt*  
**PR911/3** - € 33  
 Schermo opaco 3 mt  
**PR911/10** - € 110  
 Schermo opaco 10 mt



**PR901** - € 20  
 Schermo trasparente 2 mt  
*Transparent cover 2 mt*  
**PR901/3** - € 30  
 Schermo trasparente 3 mt  
*Transparent cover 3 mt*



**PR911/NE** - € 23,50  
 Schermo nero 2 mt  
*Black cover 2 mt*

PROFILO IN ALLUMINIO  
PER SUPERFICI PIANE  
ALUMINUM PROFILES FOR SURFACE



**PR127**

Profilo in alluminio anodizzato per installazione su superfici piane

Aluminum profiles for surface



CODICE	LUNGHEZZA	COLORE	LISTINO
PR127	2 MT	Silver	27,50 €

**Può dissipare fino a 30 w/mt**  
Power dissipation up to 30 w/mt

... Elimina l'effetto puntinato (vedi pag. 118)  
Eliminate the dotted effect (see page 118)

Su questo profilo è possibile installare la strip SLP220 (vedi pagina 46)  
The SLP220 strip LED can be installed on this profile (see page 46)

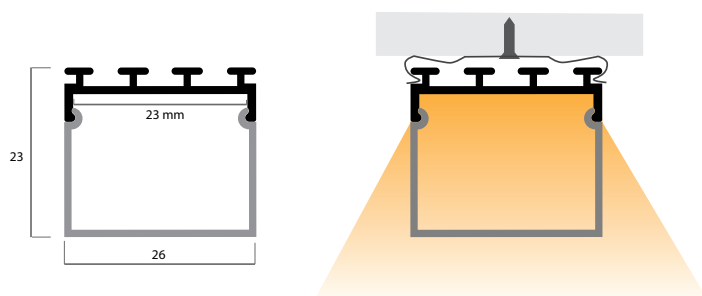

ACCESSORI - ACCESSORIES



**EN927** - € 1  
Staffa per profilo  
Flexible mounting plate



**EN127** - € 1  
Tappo chiuso  
Closed end cap



**EN127/1** - € 1  
Tappo forato  
End cap with hole

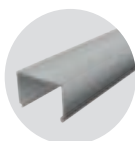

**PR927** - € 27,50  
Schermo opaco 2 mt  
White cover 2 mt



**SN560** - € 9,50  
Kit sospensione\*  
Suspension kit\*

\* Per sospendere un profilo di 2mt  
occorrono 2 kit sospensione  
\* 2 suspension kits are required to  
suspend a 2m profile



PROFILO IN ALLUMINIO  
PER SUPERFICI PIANE  
ALUMINUM PROFILES FOR SURFACE



Profilo in alluminio anodizzato per installazione su superfici piane

Aluminum profiles for surface

**PR118**

CODICE	LUNGHEZZA	COLORE	LISTINO
PR118	2 MT	Silver	€ 20,50

**Può dissipare fino a 16 w/mt**  Elimina l'effetto puntinato (vedi pag. 118)  
Power dissipation up to 16 w/mt Eliminate the dotted effect (see page 118)

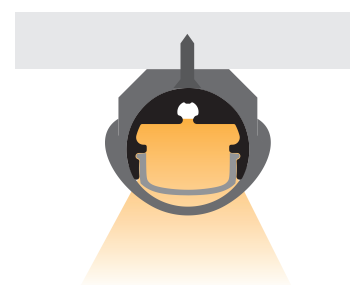
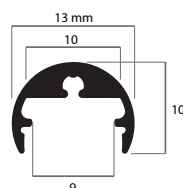

ACCESSORI - ACCESSORIES



**EN008** - € 2,50  
Staffa per fissaggio  
Plastic mounting plate



**EN108** - € 1  
Tappo chiuso  
Closed end cap



**EN108/1** - € 1  
Tappo forato  
End cap with hole



**PR907** - € 19  
Schermo bianco opaco 2 mt  
White cover 2 mt



**PR908** - € 11,50  
Schermo semi-trasparente  
ghiacciato 2 mt  
Frosted semi-transparent  
cover 2 mt



**EN088** - € 44,50  
Coppia di staffe in metallo  
Metal holder set

# PR230

Profilo in alluminio anodizzato per installazione su superfici piane Aluminum profiles for surface



CODICE	LUNGHEZZA	COLORE	LISTINO
PR230	2 MT	Silver	72 €

**Può dissipare fino a 40 w/mt**  Elimina l'effetto puntinato (vedi pag. 118)  
*Power dissipation up to 40 w/mt* *Eliminate the dotted effect (see page 118)*

Disponibile anche a Incasso: pag. 144 | Sospensione: pag. 149  
*Also available Recessed: pag. 144 | Suspension: pag. 149*

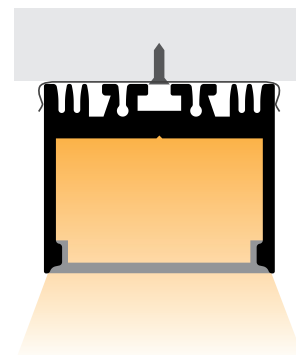
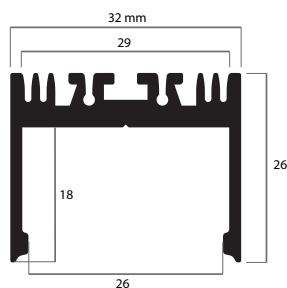

## ACCESSORI - ACCESSORIES



**EN230X** - € 6  
 Staffa orientabile  
*Adjustable bracket*



**PR931** - € 23,50  
 Schermo opaco 2 mt  
*White cover 2 mt*

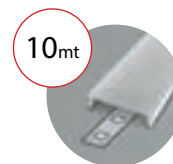

**PR931/10** - € 122  
 Schermo opaco 10 mt  
*White cover 10 mt*



**CO230X** - € 7  
 Connettore lineare  
*Linear connector*



**CO230\*** - € 28,50  
 Angolo 90°  
*Corner 90°*



**CO230C\*** - € 42,50  
 Angolo a croce  
*Cross corner*



**EN030** - € 2,50  
 Staffa per profilo  
*Flexible mounting plate*

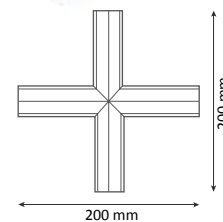
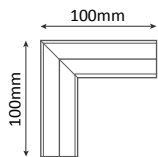

**EN231** - € 3,50  
 Tappo in metallo  
*Metal cap*



**CO230P\*** - € 28,50  
 Angolo Parete/Soffitto 90°  
*Wall / Ceiling Corner 90°*



**CO230T\*** - € 34  
 Angolo a T  
*T Corner*

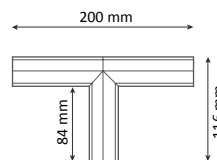
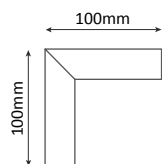

\*Per l'installazione degli angolari è necessario il connettore CO230X  
 \*The CO230X connector is required to install the corner pieces

## PROFILI SUPERFICI MINI SURFACE MINI ALUMINUM PROFILES

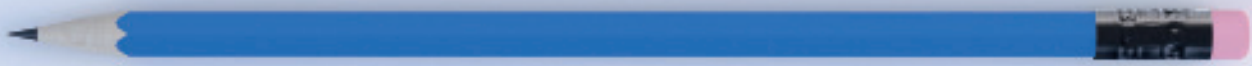

Profilo miniaturizzato per installazioni su superfici piane

Mini Aluminum profile can be used on flat surfaces

**PR105**

CODICE	LUNGHEZZA	COLORE	LISTINO
PR105	2 MT	Silver	20,50 €

**Può dissipare fino a 16 w/mt**  
Power dissipation up to 16 w/mt

... Elimina l'effetto puntinato (vedi pag. 118)  
Eliminate the dotted effect (see page 118)

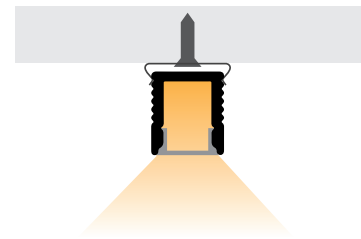

### ACCESSORI - ACCESSORIES



**EN005** - € 1,50  
Staffa per profilo  
Flexible mounting plate



**EN105** - € 1  
Tappo chiuso grigio  
Gray closed end cap



**EN105/1** - € 1  
Tappo forato grigio  
Gray end cap with hole



**PR905** - € 8,50  
Schermo trasparente 2 mt  
Transparent cover 2 mt

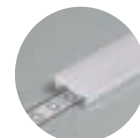

**PR915** - € 11,50  
Schermo opaco 2 mt  
White cover 2 mt



## PR113

Profili in alluminio anodizzato per installazione su superfici piane

Aluminum profiles for surface



CODICE	LUNGHEZZA	COLORE	LISTINO
PR113	2 MT	Silver	20,50 €

**Può dissipare fino a 16 w/mt**  
Power dissipation up to 16 w/mt

 Elimina l'effetto puntinato (vedi pag. 118)  
Eliminate the dotted effect (see page 118)

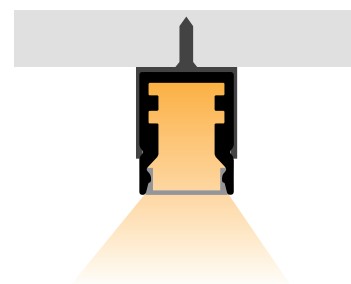
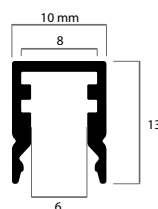

### ACCESSORI - ACCESSORIES



**EN013** - € 1,50  
Staffa per profilo  
Flexible mounting plate



**EN113** - € 1  
Tappo chiuso grigio  
Gray closed end cap



**EN113/1** - € 1  
Tappo forato grigio  
Gray end cap with hole

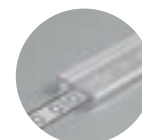

**PR903** - € 8,50  
Schermo trasparente 2 mt  
Transparent cover 2 mt

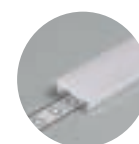

**PR913** - € 11,50  
Schermo opaco 2 mt  
White cover 2 mt



Profili in alluminio anodizzato per installazione su superfici piane

Aluminum profiles for surface

**PR110**



CODICE	LUNGHEZZA	COLORE	LISTINO
PR110	2 MT	Silver	21 €

**Può dissipare fino a 20 w/mt**  
Power dissipation up to 20 w/mt

... Elimina l'effetto puntinato (vedi pag. 118)  
Eliminate the dotted effect (see page 118)

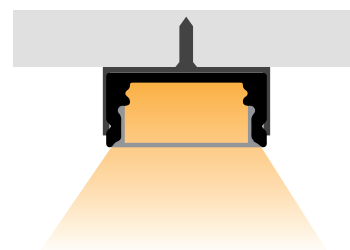
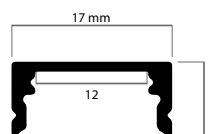

ACCESSORI - ACCESSORIES



**EN010** - € 1,20  
Staffa per profilo  
Flexible mounting plate



**EN110** - € 1  
Tappo chiuso grigio  
Gray closed end cap



**EN110/1** - € 1  
Tappo forato grigio  
Gray end cap with hole

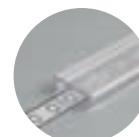

**PR990** - € 9  
Schermo trasparente 2 mt  
Transparent cover 2 mt



**PR991** - € 10,50  
Schermo opaco 2 mt  
White cover 2 mt

PROFILO IN ALLUMINIO  
CALPESTABILE  
ALUMINIUM PROFILE WALKABLE

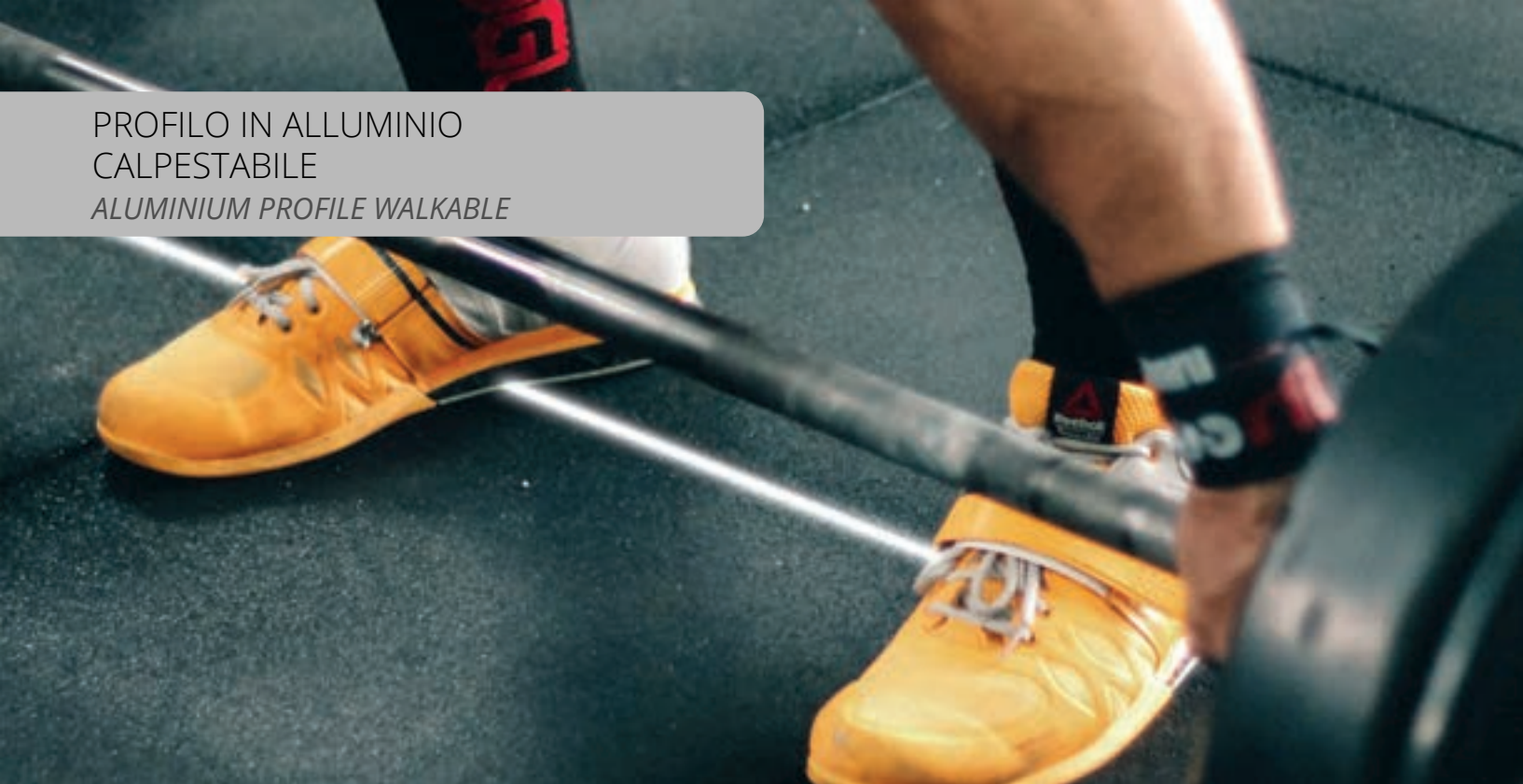

**PR115**

Profilo a pavimento calpestabile, carico statico fino a 150kg

Floor aluminum profile, static load up to 150kg

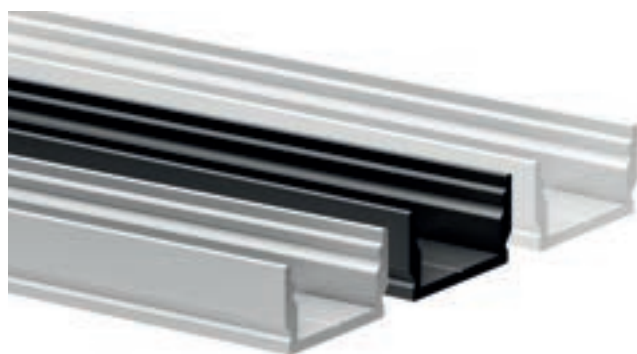

CODICE	LUNGHEZZA	COLORE	LISTINO
PR115	2 MT	Silver	22,50 €
PR115/NE	2 MT	Nero	25,50 €
PR115/BI	2 MT	Bianco	25,50 €

**Può dissipare fino a 30 w/mt**  
Power dissipation up to 30 w/mt

... Elimina l'effetto puntinato (vedi pag. 118)  
Eliminate the dotted effect (see page 118)

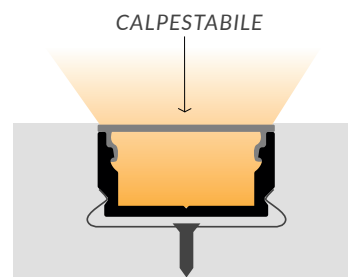
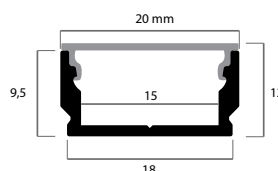

ACCESSORI - ACCESSORIES



**EN014** - € 1,50  
Staffa per profilo  
Flexible mounting plate



**EN115** - € 1  
Tappo chiuso  
Closed end cap  
**EN115/NE** - Nero / Black  
**EN115/BI** - Bianco / White



**EN115/1** - € 1  
Tappo forato  
End cap with hole  
**EN115/1/NE** - Nero / Black  
**EN115/1/BI** - Bianco / White



**PR911 F** - € 32  
Schermo opaco 2 mt calpestabile  
Walkable white cover 2 mt

PROFILO IN ALLUMINIO  
CALPESTABILE MINI  
ALUMINIUM PROFILE MINI WALKABLE



Profilo a pavimento calpestabile carico statico fino a 150Kg

Floor aluminum profile, static load up to 150Kg

**PR510F**



CODICE	LUNGHEZZA	COLORE	LISTINO
PR510F	2 MT	Silver	29 €

**Può dissipare fino a 30 w/mt** ... Elimina l'effetto puntinato (vedi pag. 118)  
Power dissipation up to 30 w/mt ... Eliminate the dotted effect (see page 118)

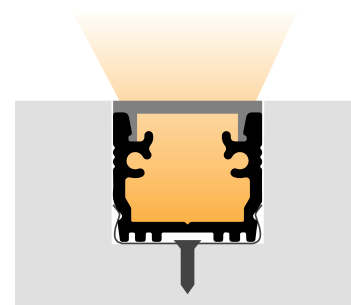
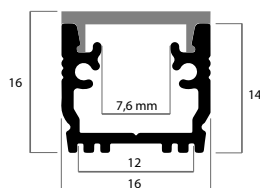

ACCESSORI - ACCESSORIES



**GU510F** - € 5,50  
Guarnizione  
Flexible mounting plate



**EN910F** - € 1,20  
Tappo chiuso grigio  
Gray closed end cap



**PR910F** - € 27  
Schermo opaco 2 mt  
White cover 2 mt



# PROFILI IN ALLUMINIO AD INCASSO

*RECESSED*

*ALUMINUM PROFILES*



PROFILO IN ALLUMINIO  
AD INCASSO  
RECESSED ALUMINIUM PROFILE



PR200



CODICE	LUNGHEZZA	COLORE	LISTINO
PR200	2 MT	Silver	20 €
PR200/NE	2 MT	Nero	23,50 €
PR200/BI	2 MT	Bianco	23,50 €
PR200/3	3 MT	Silver	32 €
PR200/3NE	3 MT	Nero	36 €
PR200/3BI	3 MT	Bianco	36 €

Confezioni da 10pz | Packs of 10pcs

COLORI SPECIAL

● PR200/TDM	2 MT	Testa di Moro Dark Brown	41 €
● PR200/OTN	2 MT	Ottone Brass	41 €
● PR200/ORO	2 MT	Oro Gold	41 €

Codici RAL pag. 121 - RAL code pag.121

**Può dissipare fino a 20 w/mt**  
Power dissipation up to 20 w/mt

● Elimina l'effetto puntinato (vedi pag. 118)  
Eliminate the dotted effect (see page 118)

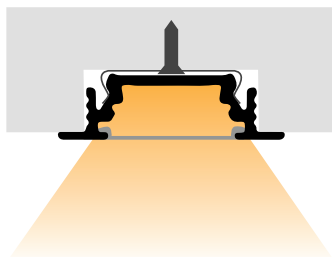
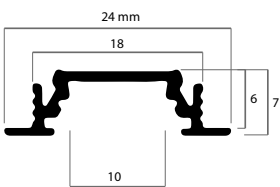

ACCESSORI - ACCESSORIES



**ENX** - € 6  
Staffa in alluminio per l'installazione del profilo all'interno di controsoffitti.  
Aluminum bracket for installation inside suspending ceilings.



**EN000** - € 1  
Staffa per profilo  
Flexible mounting plate



**EN201** - € 1  
Tappo forato grigio  
Gray End cap with hole  
**EN201/NE** - Nero / Black  
**EN201/BI** - Bianco / White



**PR910** - € 10,5  
Schermo opaco 2 mt  
White cover 2 mt  
**PR910/3** - € 17  
3 mt  
**PR910/10** - € 55  
10 mt



**PR900** - € 9  
Schermo trasparente 2 mt  
Transparent cover 2 mt  
**PR900/3** - € 13  
Schermo trasparente 3 mt  
Transparent cover 3 mt

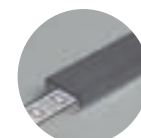

**PR910/NE** - € 17  
Schermo nero 2 mt  
Black cover 2 mt

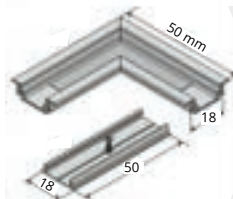
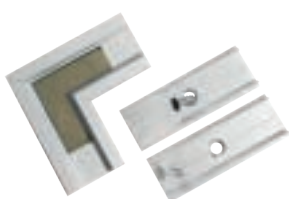

Connettore angolo 90° per profilo ad incasso PR200, completo di staffe per il fissaggio.  
90° connector for PR200 surfaces with attachment brackets.

CODICE	COLORE	LISTINO
CO200	Silver	21 €
CO200/BI	Bianco	26 €
CO200/NE	Nero	26 €

## PR214



CODICE	LUNGHEZZA	COLORE	LISTINO
PR214	2 MT	Silver	24,50 €

**Può dissipare fino a 30 w/mt**  
Power dissipation up to 30 w/mt

... Elimina l'effetto puntinato (vedi pag. 118)  
Eliminate the dotted effect (see page 118)

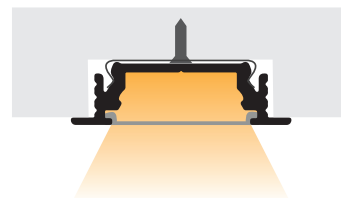
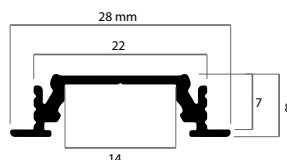

### ACCESSORI - ACCESSORIES



**EN014** - € 1,50  
Staffa per profilo PR214  
PR214 flexible mounting plate



**EN214/1** - € 1  
Tappo forato  
End cap with hole



**PR911** - € 22  
Schermo opaco 2 mt  
White cover 2 mt  
**PR911/3** - € 33  
Schermo opaco 3 mt  
**PR911/10** - € 110  
Schermo opaco 10 mt



**PR901** - € 20  
Schermo trasparente 2 mt  
Transparent cover 2 mt  
**PR901/3** - € 30  
Schermo trasparente 3 mt  
Transparent cover 3 mt

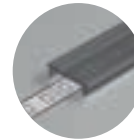

**PR911/NE** - € 23,50  
Schermo nero 2 mt  
Black cover 2 mt

## PR210



CODICE	LUNGHEZZA	COLORE	LISTINO
PR210	2 MT	Silver	32 €

**Può dissipare fino a 30 w/mt**  
Power dissipation up to 30 w/mt

... Elimina l'effetto puntinato (vedi pag. 118)  
Eliminate the dotted effect (see page 118)

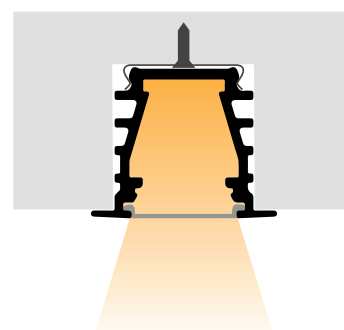
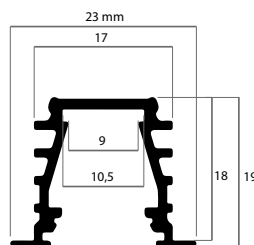

### ACCESSORI - ACCESSORIES



**EN000** - € 1  
Staffa per profilo PR210  
PR210 flexible mounting plate



**EN210/1** - € 1  
Tappo forato  
End cap with hole

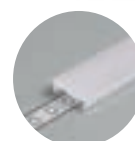

**PR910** - € 10,5  
Schermo opaco 2 mt  
White cover 2 mt  
**PR910/3** - € 17  
3 mt  
**PR910/10** - € 55  
10 mt

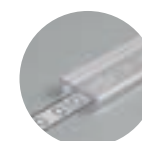

**PR900** - € 9  
Schermo trasparente 2 mt  
Transparent cover 2 mt  
**PR900/3** - € 13  
Schermo trasparente 3 mt  
Transparent cover 3 mt

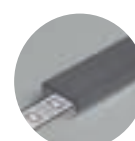

**PR910/NE** - € 17  
Schermo nero 2 mt  
Black cover 2 mt

PROFILO IN ALLUMINIO  
AD INCASSO  
RECESSED ALUMINIUM PROFILE

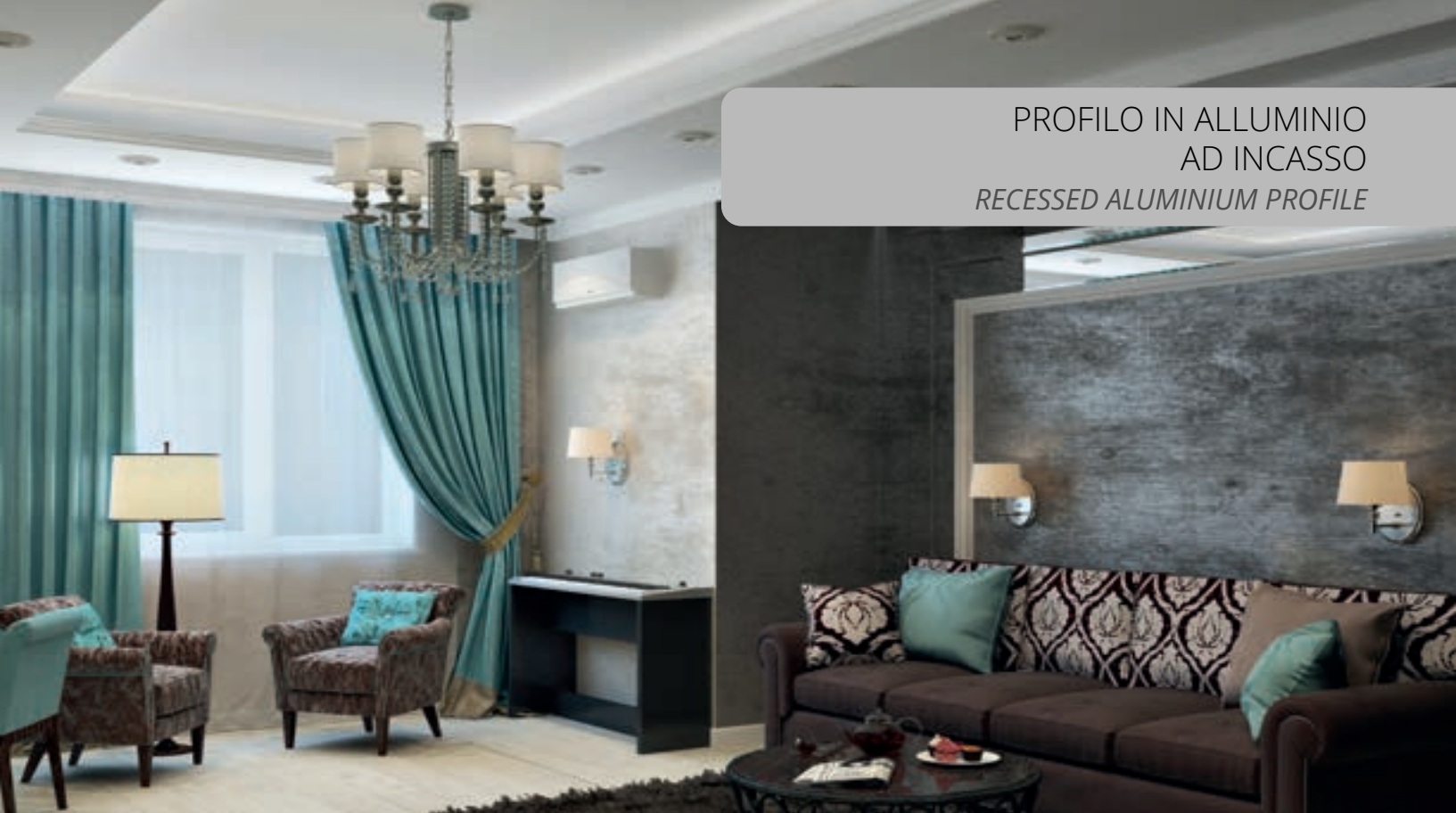

PR250

CODICE	LUNGHEZZA	COLORE	LISTINO
PR250/BI	2 MT	Bianco	53 €

**Può dissipare fino a 30 w/mt**  Elimina l'effetto puntinato (vedi pag. 118)  
Power dissipation up to 30 w/mt *Eliminate the dotted effect (see page 118)*

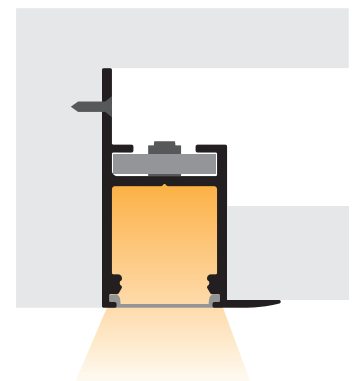
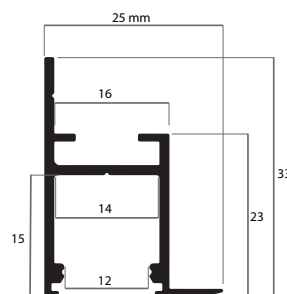

ACCESSORI - ACCESSORIES



**CO250X** - € 10,50  
Giunzione Lineare  
Linear junction



**CO250** - € 10,50  
Angolo Parete/Soffitto 90°  
Wall / Ceiling Corner 90°



**PR910** - € 10,5  
Schermo opaco 2 mt  
White cover 2 mt  
**PR910/3** - € 17  
3 mt  
**PR910/10** - € 55  
10 mt



**PR900** - € 9  
Schermo trasparente 2 mt  
Transparent cover 2 mt  
**PR900/3** - € 13  
Schermo trasparente 3 mt  
Transparent cover 3 mt



**PR910/NE** - € 17  
Schermo nero 2 mt  
Black cover 2 mt

PROFILO AD INCASSO  
A SCOMPARSA  
CORNER TRIMLESS RECESSED PROFILE



PR260

Profilo in alluminio anodizzato per installazioni a scomparsa in cartongesso o legno.

*Recessed trimless aluminium profile for plaster board or wood ceiling.*



CODICE	LUNGHEZZA	COLORE	LISTINO
PR260	2 MT	Silver	100 €

**Può dissipare fino a 40 w/mt**  
*Power dissipation up to 40 w/mt*

●●● Elimina l'effetto puntinato (vedi pag. 118)  
*Eliminate the dotted effect (see page 118)*

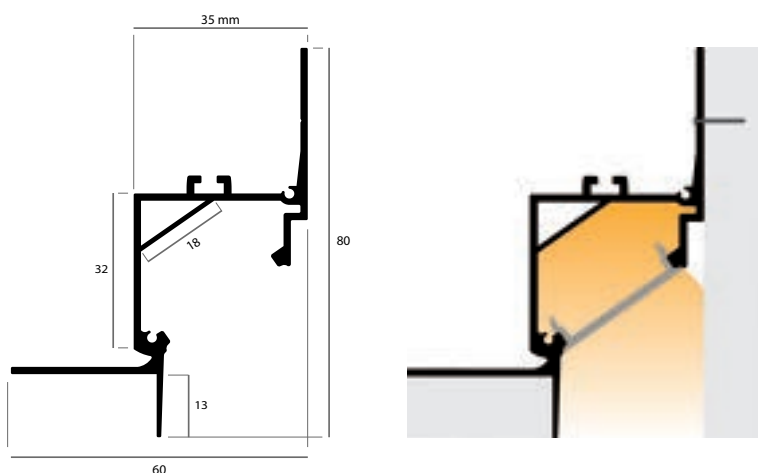

ACCESSORI - ACCESSORIES



**PR931** - € 23,50  
Schermo opaco 2 mt  
*White cover 2 mt*



**CO230X** - € 7  
Connettore lineare  
*Linear connector*

PROFILO AD INCASSO  
A SCOMPARSA  
RECESSED PROFILE DISAPPEARING



Profilo in alluminio anodizzato per installazioni a scomparsa in cartongesso o legno

Recessed trimless aluminum profile for dry or wood ceiling

PR221

CODICE	LUNGHEZZA	COLORE	LISTINO
PR221	2 MT	Silver	30,50 €

**Può dissipare fino a 28 w/mt** Elimina l'effetto puntinato (vedi pag. 118)  
Power dissipation up to 28 w/mt *Eliminate the dotted effect (see page 118)*

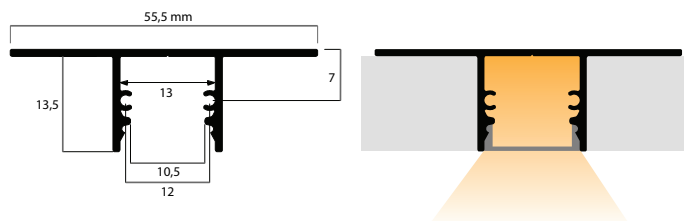

ACCESSORI - ACCESSORIES



**EN221** - € 2,30  
Tappo  
End Cap

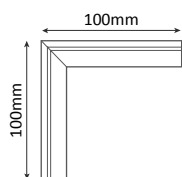

**CO221P** - € 30  
Angolo Parete/Soffitto 90°  
Wall / Ceiling Corner 90°  
Dimensioni: 10cm x 10cm  
Dimensions: 10cm x 10cm

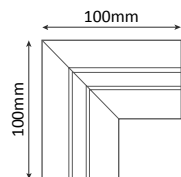

**CO221** - € 30  
Angolo 90°  
Corner 90°  
Dimensioni: 10cm x 10cm  
Dimensions: 10cm x 10cm

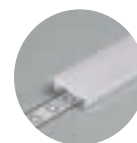

**PR910** - € 10,5  
Schermo opaco 2 mt  
White cover 2 mt  
**PR910/3** - € 17  
3 mt



**PR910/10** - € 55  
10 mt  
**PR900** - € 9  
Schermo trasparente 2 mt  
Transparent cover 2 mt  
**PR900/3** - € 13  
Schermo trasparente 3 mt  
Transparent cover 3 mt



**PR910/NE** - € 17  
Schermo nero 2 mt  
Black cover 2 mt

PROFILO AD INCASSO  
A SCOMPARSA  
*RECESSED PROFILE DISAPPEARING*



**PR223**

Profilo in alluminio anodizzato per installazioni a scomparsa in cartongesso, legno o muratura.  
Possibilità di installazione anche a cartongesso già montato.

*Recessed trimless aluminium profile for plaster, wood ceiling or masonry.  
Possibility of installation even with plasterboard already mounted.*



CODICE	LUNGHEZZA	COLORE	LISTINO
PR223	2 MT	Silver	38 €

**Può dissipare fino a 28 w/mt**  Elimina l'effetto puntinato (vedi pag. 118)  
*Power dissipation up to 28 w/mt* *Eliminate the dotted effect (see page 118)*

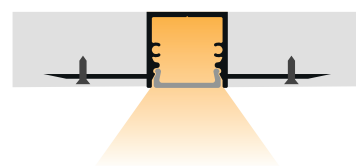
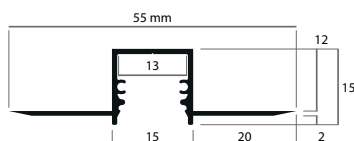

ACCESSORI - ACCESSORIES



**EN221** - € 2,30  
Tappo  
End Cap



**PR910** - € 10,50  
Schermo opaco 2 mt  
*White cover 2 mt*  
**PR910/3** - € 17  
3 mt  
**PR910/10** - € 55  
10 mt



**PR900** - € 9  
Schermo trasparente 2 mt  
*Transparent cover 2 mt*  
**PR900/3** - € 13  
Schermo trasparente 3 mt  
*Transparent cover 3 mt*

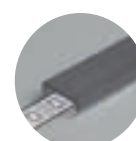

**PR910/NE** - € 17  
Schermo nero 2 mt  
*Black cover 2 mt*

PROFILO AD INCASSO  
A SCOMPARSA  
RECESSED PROFILE DISAPPEARING



Profilo in alluminio anodizzato per installazioni a scomparsa in cartongesso, legno o muratura

Recessed trimless aluminium profile for dry, wood ceiling or masonry

**PR225**

CODICE	LUNGHEZZA	COLORE	LISTINO
PR225	2 MT	Silver	50 €

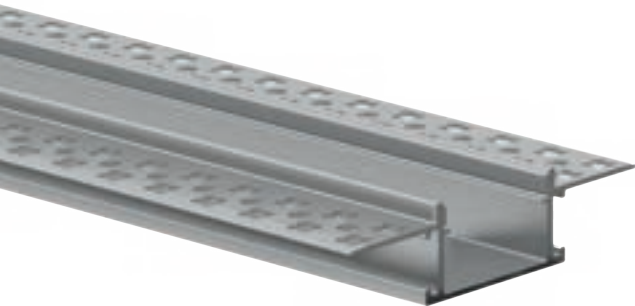

**Può dissipare fino a 40 w/mt**  
Power dissipation up to 40 w/mt

... Elimina l'effetto puntinato (vedi pag. 118)  
Eliminate the dotted effect (see page 118)

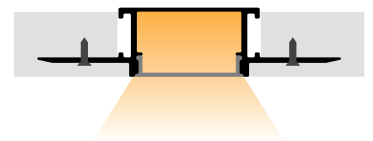
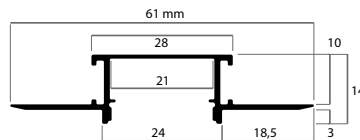

ACCESSORI - ACCESSORIES



**EN225** - € 2,30  
Tappo  
End Cap



**PR925** - € 15  
Schermo opaco 2 mt  
White cover 2 mt

PROFILO MULTIFUNZIONE  
A SCOMPARSA  
MULTIFUNCTION PROFILE DISAPPEARING



PR230

Profilo in alluminio anodizzato per installazioni a scomparsa in cartongesso o legno

Recessed trimless aluminum profile for dry or wood ceiling



CODICE	LUNGHEZZA	COLORE	LISTINO
PR230	2 MT	Silver	72 €

**Può dissipare fino a 40 w/mt**  Elimina l'effetto puntinato (vedi pag. 118)  
Power dissipation up to 40 w/mt *Eliminate the dotted effect (see page 118)*

Disponibile anche a Superficie: pag. 130 | Sospensione: pag. 149  
Also available in Surface: page 130 | Suspension: page 149

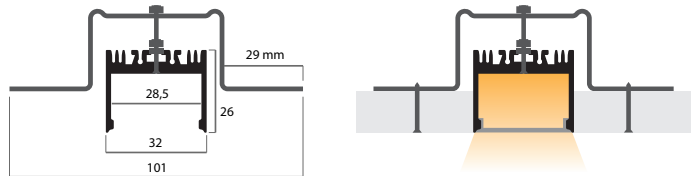

ACCESSORI - ACCESSORIES



**ENX230** - € 8,50  
Staffa montaggio  
controsoffitto  
Mounting bracket  
countertop



**PR931** - € 23,50  
Schermo opaco 2 mt  
White cover 2 mt



**PR931/10** - € 122  
Schermo opaco 10  
mt  
White cover 10 mt



**CO230X** - € 7  
Connettore lineare  
Linear connector

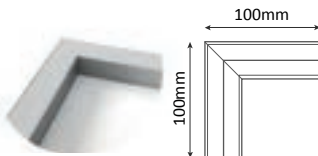

**CO230\*** - € 28,50  
Angolo 90°  
Corner 90°

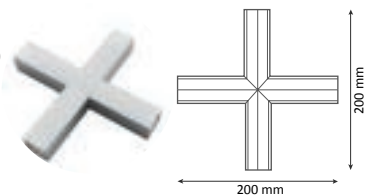

**CO230C\*** - € 42,50  
Angolo a croce  
Cross corner



**EN231** - € 3,50  
Tappo in metallo  
Metal cap

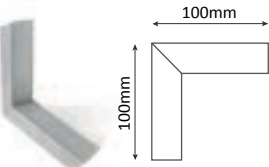

**CO230P\*** - € 28,50  
Angolo Parete/Soffitto 90°  
Wall / Ceiling Corner 90°

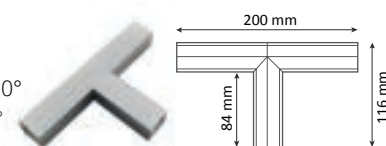

**CO230T\*** - € 34  
Angolo a T  
T Corner

\*Per l'installazione degli angolari è necessario il connettore CO230X  
\*The CO230X connector is required to install the corner pieces



PROFILO ANGOLARE  
SUPERFICI PIANE  
ANGULAR PROFILE - FLAT SURFACE

**PR331**

Profilo angolare per installazioni su superfici piane

Angular aluminum profile for flat surfaces

CODICE	LUNGHEZZA	COLORE	LISTINO
PR331	2 MT	Silver	37 €

**Può dissipare fino a 28 w/mt**  Elimina l'effetto puntinato (vedi pag. 118)  
Power dissipation up to 28 w/mt *Eliminate the dotted effect (see page 118)*

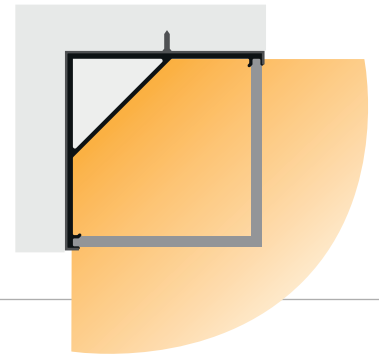
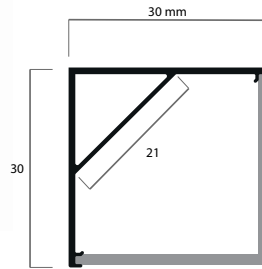

ACCESSORI - ACCESSORIES



**EN031** - € 1,50  
Staffa per profilo PR331  
Flexible mounting plate



**EN331** - € 1,50  
Tappo chiuso  
Closed end cap



**EN331/1** - € 1,50  
Tappo forato  
End cap with hole



**PR933** - € 15  
Schermo opaco 2 mt  
White cover 2 mt

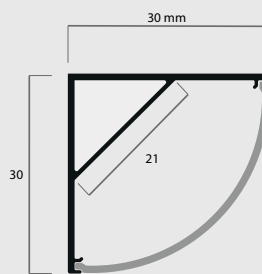

Novità: Nuovo schermo curvo  
News: New curved cover

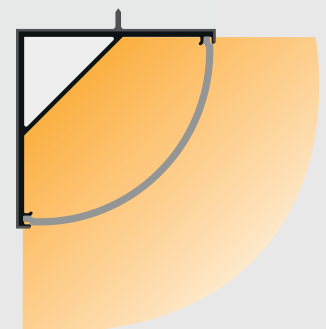

ACCESSORI - ACCESSORIES



**EN031** - € 1,50  
Staffa per profilo PR331  
Flexible mounting plate



**EN335** - € 1,50  
Tappo curvo chiuso  
Curved cap closed



**EN335/1** - € 1,50  
Tappo curvo forato  
Curved end cap with hole



**PR935** - € 15  
Schermo tondo opaco 2 mt  
White round cover 2 mt

PROFILO IN ALLUMINIO  
ANGOLARE  
ALUMINIUM PROFILE ANGULAR



PR300

Profilo per installazioni su superfici piane, a seconda del verso utilizzato si può ottenere un'angolazione differente (30° / 60°)

Aluminum profile for flat surfaces, according to the direction, it can be possible to create an angle of 30° or 60°

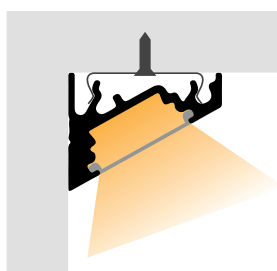
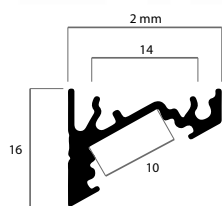

CODICE	LUNGHEZZA	COLORE	LISTINO
PR300	2 MT	Silver	24,50 €
PR300/NE	2 MT	Nero	27,50 €
PR300/BI	2 MT	Bianco	27,50 €
PR300/3	3 MT	Silver	38 €
PR300/3NE	3 MT	Nero	42,50 €
PR300/3BI	3 MT	Bianco	42,50 €

Confezioni da 10pz | Packs of 10pcs

COLORI SPECIAL

● PR300/TDM	2 MT	Testa di Moro Dark Brown	49 €
● PR300/OTN	2 MT	Ottone Brass	49 €
● PR300/ORO	2 MT	Oro Gold	49 €

Codici RAL pag. 121 - RAL code pag.121

**Può dissipare fino a 28 w/mt**  
Power dissipation up to 28 w/mt

... Elimina l'effetto puntinato (vedi pag. 118)  
Eliminate the dotted effect (see page 118)

ACCESSORI - ACCESSORIES



**EN000** - € 1  
Staffa per profilo PR300  
Flexible mounting plate



**EN300** - € 1  
Tappo chiuso grigio  
Gray closed end cap  
**EN300/NE** - Nero / Black  
**EN300/BI** - Bianco / White



**EN301** - € 1  
Tappo forato grigio  
Gray end cap with hole  
**EN301/NE** - Nero / Black  
**EN301/BI** - Bianco / White



**PR910** - € 10,5  
Schermo opaco 2 mt  
White cover 2 mt  
**PR910/3** - € 17  
3 mt  
**PR910/10** - € 55  
10 mt

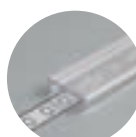

**PR900** - € 9  
Schermo trasparente 2 mt  
Transparent cover 2 mt  
**PR900/3** - € 13  
Schermo trasparente 3 mt  
Transparent cover 3 mt

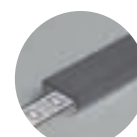

**PR910/NE** - € 17  
Schermo nero 2 mt  
Black cover 2 mt

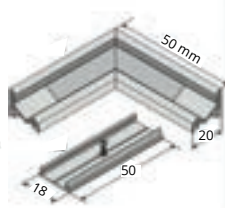

Connettore angolo 90° per profilo angolare PR300, completo di staffe per il fissaggio.  
90° connector for PR300 surfaces with attachment brackets.

CODICE	COLORE	LISTINO
CO300	Silver	21 €
CO300/BI	Bianco	26 €
CO300/NE	Nero	26 €

PROFILO IN ALLUMINIO  
ANGOLARE  
ALUMINIUM PROFILE ANGULAR

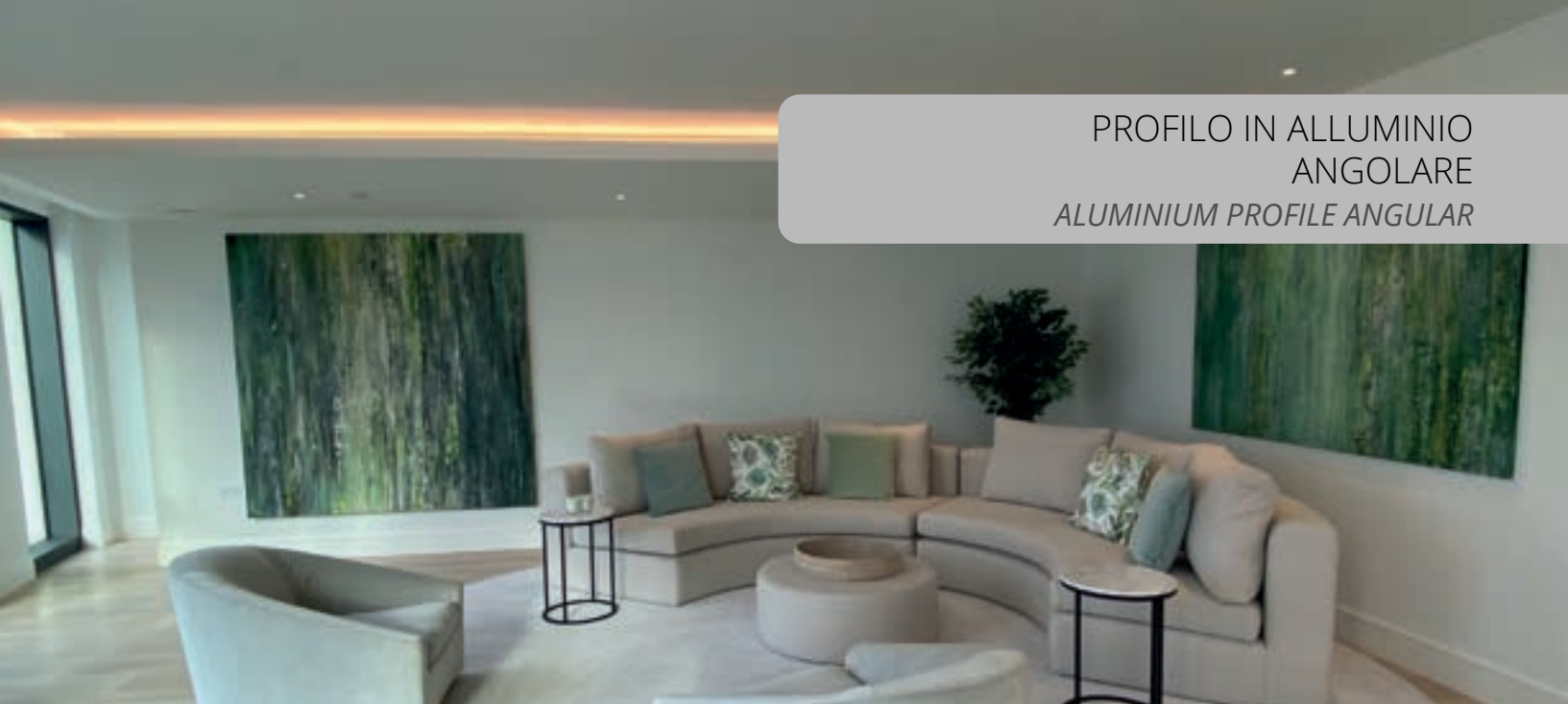

PR314



CODICE	LUNGHEZZA	COLORE	LISTINO
PR314	2 MT	Silver	31 €

**Può dissipare fino a 30 w/mt** ... Elimina l'effetto puntinato (vedi pag. 118)  
*Power dissipation up to 30 w/mt* ... *Eliminate the dotted effect (see page 118)*

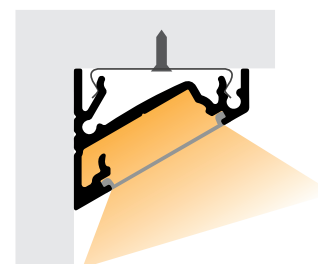
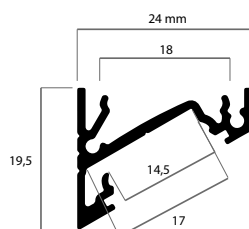

ACCESSORI - ACCESSORIES



**EN014** - € 1,50  
 Staffa per profilo PR314  
*Flexible mounting plate*



**EN314** - € 1  
 Tappo chiuso  
*Closed end cap*



**EN314/1** - € 1  
 Tappo forato  
*End cap with hole*



**PR911** - € 22  
 Schermo opaco 2 mt  
*White cover 2 mt*  
**PR911/3** - € 33  
 Schermo opaco 3 mt  
**PR911/10** - € 110  
 Schermo opaco 10 mt



**PR901** - € 20  
 Schermo trasparente 2 mt  
*Transparent cover 2 mt*  
**PR901/3** - € 30  
 Schermo trasparente 3 mt  
*Transparent cover 3 mt*

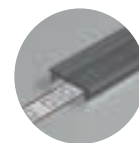

**PR911/NE** - € 23,50  
 Schermo nero 2 mt  
*Black cover 2 mt*

PROFILO IN ALLUMINIO  
A SOSPENSIONE  
ALUMINUM PROFILE SUSPENSION



**PR560**

Profilo in alluminio anodizzato doppia emissione per installazioni a sospensione.

Double emission anodized aluminum profile for suspended installations



CODICE	LUNGHEZZA	COLORE	LISTINO
PR560/BI + PR561/BI	2 MT	Bianco	106 € + 37 €
PR560/NE + PR561/NE	2 MT	Nero	106 € + 37 €

Il prodotto completo è composto dal codice PR560 + PR561 (pag 126)  
The complete product consists of the code PR560 + PR561 (page 126)

**Può dissipare fino a 2x30 w/mt**  
Power dissipation up to 2x30 w/mt

... Elimina l'effetto puntinato (vedi pag. 118)  
Eliminate the dotted effect (see page 118)

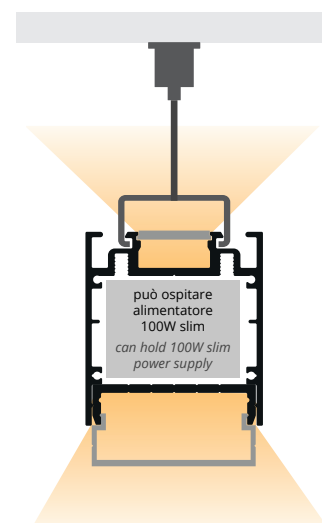
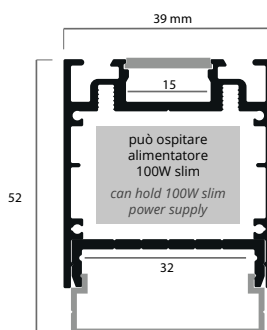

ACCESSORI - ACCESSORIES



**EN006** - € 1,50  
Staffa  
Bracket



**EN560/BI** - € 2,50  
Tappo chiuso bianco  
White end cap  
**EN560/NE** - nero  
Black end cap



**SN560/C** - € 9,50  
Kit sospensione\*  
Suspension kit\*



**PR960/1** - € 14  
Schermo opaco 2 mt  
White cover 2 mt



**PR960** - € 23,50  
Schermo opaco 2 mt  
White cover 2 mt

\* Per sospendere un profilo di 2mt  
occorrono 2 kit sospensione  
\* 2 suspension kits are required to  
suspend a 2m profile

# PROFILO MULTIFUNZIONE A SOSPENSIONE MULTIFUNCTION PROFILE SUSPENSION

Profilo in alluminio anodizzato per installazioni a sospensione

Suspension trimless aluminum profile

**PR230**



CODICE	LUNGHEZZA	COLORE	LISTINO
PR230	2 MT	Silver	72 €

**Può dissipare fino a 40 w/mt**  
Power dissipation up to 40 w/mt

Elimina l'effetto puntinato (vedi pag. 118)  
Eliminate the dotted effect (see page 118)

Disponibile anche a Superficie: pag. 130 | Incasso: pag. 144  
Also available in Surface: page 130 | Recessed: page 144

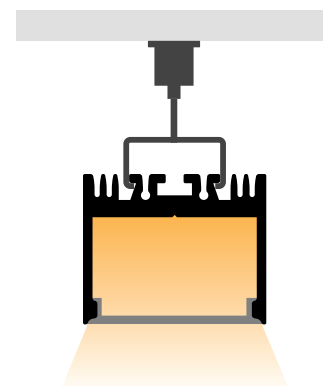
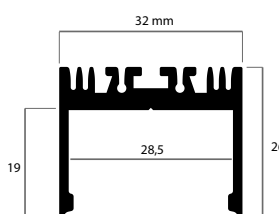

## ACCESSORI - ACCESSORIES



**SN230\*** - € 16  
Kit sospensione  
con rosone bianco  
White suspension kit



**SN230/C\*** - € 10,50  
Kit sospensione  
Suspension kit



**PR931** - € 22  
Schermo opaco 2 mt  
White cover 2 mt

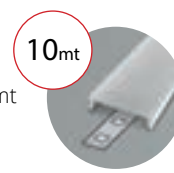

**PR931/10** - € 122  
Schermo opaco  
10 mt  
White cover 10 mt



**CO230X** - € 7  
Connettore lineare  
Linear connector



**CO230\*\*** - € 28,50  
Angolo 90°  
Corner 90°



**CO230C\*\*** - € 42,50  
Angolo a croce  
Cross corner



**EN231** - € 3,50  
Tappo in metallo  
Metal cap



**CO230P\*\*** - € 28,50  
Angolo Parete/Soffitto 90°  
Wall / Ceiling Corner 90°



**CO230T\*\*** - € 34  
Angolo a T  
T Corner

\*Si consiglia l'uso di 2 kit per ogni barra da 2 metri \*\*Per l'installazione degli angolari è necessario il connettore CO230X  
\*Is recommend using 2 kits for each 2 meter bar \*\*The CO230X connector is required to install the corner pieces

## PR550



CODICE	LUNGHEZZA	COLORE	LISTINO
PR550	2 MT	Silver	95 €
PR550/BI	2 MT	Bianco	100 €
PR550/NE	2 MT	Nero	116,50 €

**Può dissipare fino a 55 w/mt**  
Power dissipation up to 55 w/mt

... Elimina l'effetto puntinato (vedi pag. 118)  
Eliminate the dotted effect (see page 118)

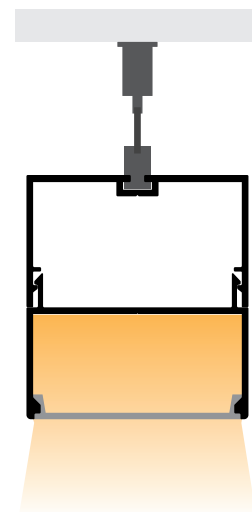
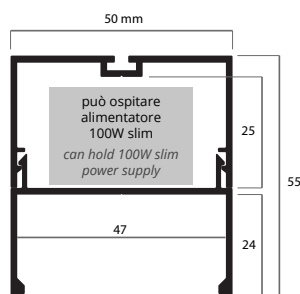

### ACCESSORI - ACCESSORIES

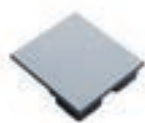

**EN550** - € 3,50  
Tappo in plastica silver  
Silver plastic cap



**EN550/BI** - € 3,50  
Tappo in plastica bianco  
White plastic cap  
**EN550/NE** - Nero  
Black plastic cap



**PR950** - € 28,50  
Schermo opaco 2 mt  
White cover 2 mt



**SN550/C** - € 9,50  
Kit sospensione bianco\*  
White suspension kit\*



**CO550X** - € 7  
Connettore lineare  
Linear connector

## PR570

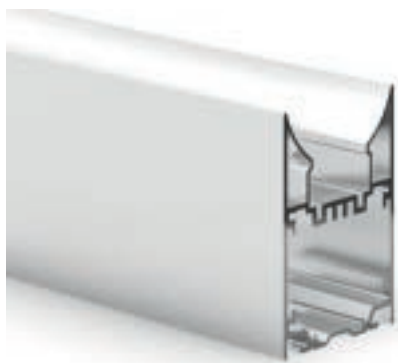

CODICE	LUNGHEZZA	COLORE	LISTINO
PR570	2 MT	Silver	153,50 €

**Può dissipare fino a 60 w/mt**  
Power dissipation up to 60 w/mt

... Elimina l'effetto puntinato (vedi pag. 118)  
Eliminate the dotted effect (see page 118)

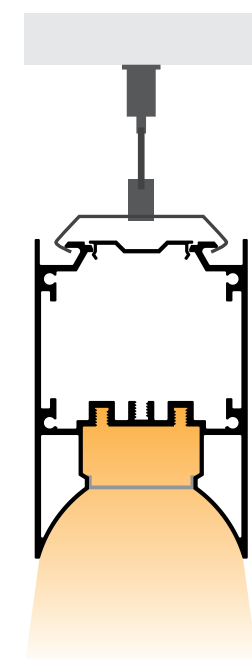
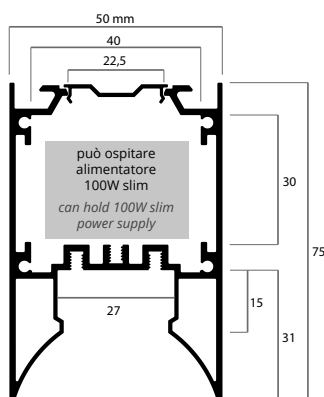

### ACCESSORI - ACCESSORIES



**EN570** - € 6  
Tappo  
End cap



**SN570/C** - € 9,50  
Kit sospensione\*  
Suspension kit\*



**PR970** - € 23,50  
Schermo opaco 2 mt  
White cover 2 mt

\* Per sospendere un profilo di 2mt  
occorrono 2 kit sospensione  
\* 2 suspension kits are required to  
suspend a 2m profile

PROFILO IN ALLUMINIO  
A SOSPENSIONE  
ALUMINUM PROFILE SUSPENSION

Profilo in alluminio verniciato bianco doppia emissione per installazioni a sospensione

Double emission white painted aluminum profile for suspended installations

**PR750**



CODICE	LUNGHEZZA	COLORE	LISTINO
PR750/BI	2 MT	Bianco	138 €

**Può dissipare fino a 2x30 w/mt**  Elimina l'effetto puntinato (vedi pag. 118)  
Power dissipation up to 2x30 w/mt *Eliminate the dotted effect (see page 118)*

Disponibile anche per montaggio a Parete: pag. 153  
Also available in Wall mounting: page 153

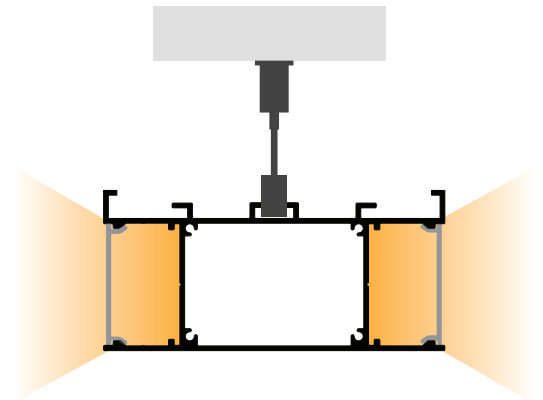
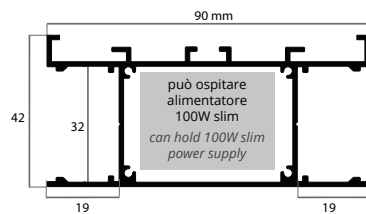

ACCESSORI - ACCESSORIES



**EN750/BI** - € 6  
Tappo  
End cap



**SN570/C** - € 9,50  
Kit sospensione\*  
Suspension kit\*

\* Per sospendere un profilo di 2mt occorrono 2 kit sospensione  
\* 2 suspension kits are required to suspend a 2m profile



**CO750X** - € 7  
Connettore lineare  
Linear connector

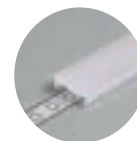

**PR975** - € 20  
Schermo opaco 2 mt  
White cover 2 mt



LED CO

---

# PROFILI IN ALLUMINIO

---

## PROFILI DA PARETE

*Per chi non può montare il controsoffitto ma non vuole rinunciare all'illuminazione lineare. Adatto sia per ambienti privati che per locali commerciali.*

## WALL PROFILES

*For those who cannot mount the false ceiling but do not want to give up linear lighting. Suitable for both private and commercial spaces.*



PROFILO IN ALLUMINIO  
DA PARETE  
WALL ALUMINUM PROFILES

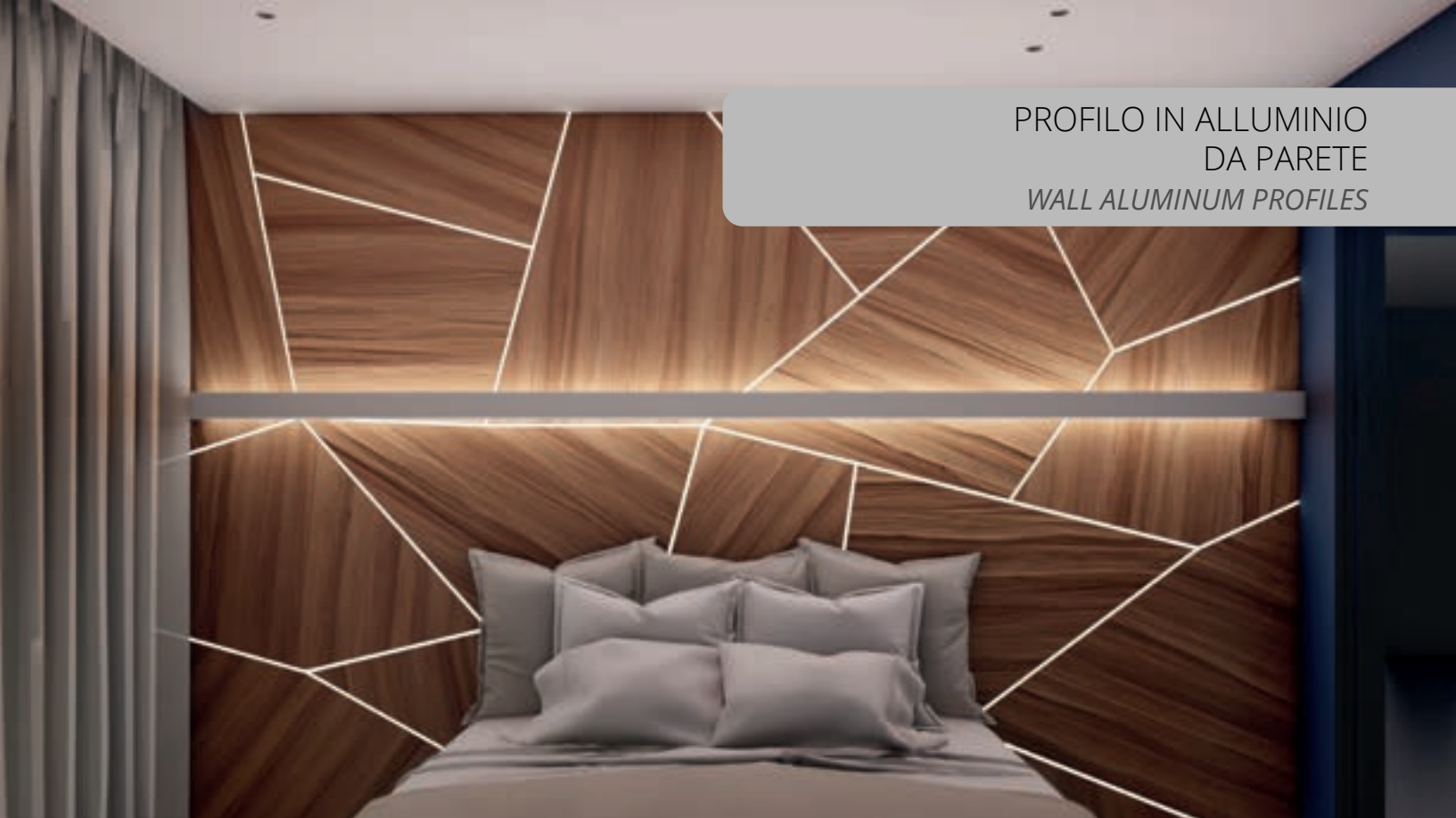

Profilo in alluminio doppia emissione per installazioni su parete o soffitto verniciato bianco.

Double emission white painted aluminum profile for wall or ceiling installations.

**PR750**



CODICE	LUNGHEZZA	COLORE	LISTINO
PR750/BI	2 MT	Bianco	138 €

**Può dissipare fino a 2x30 w/mt**  Elimina l'effetto puntinato (vedi pag. 118)  
Power dissipation up to 2x30 w/mt Eliminate the dotted effect (see page 118)

Disponibile anche per montaggio a Sospensione: pag. 151  
Also available in Suspension mounting: page 151

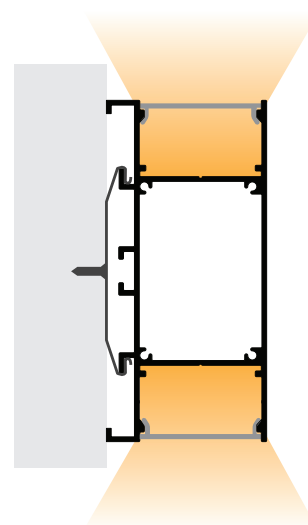
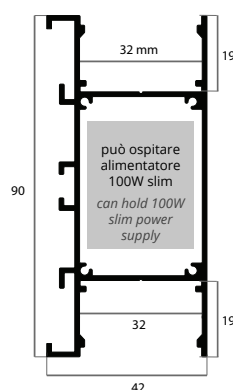

ACCESSORI - ACCESSORIES



**EN750/BI** - € 6  
Tappo  
End cap



**CO750X** - € 7  
Connettore lineare  
Linear connector



**EN075** - € 4  
Staffe posteriori  
Back brackets

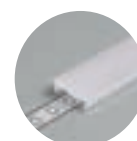

**PR975** - € 20  
Schermo opaco 2 mt  
White cover 2 mt

PROFILO IN ALLUMINIO  
DA PARETE  
WALL ALUMINUM PROFILE

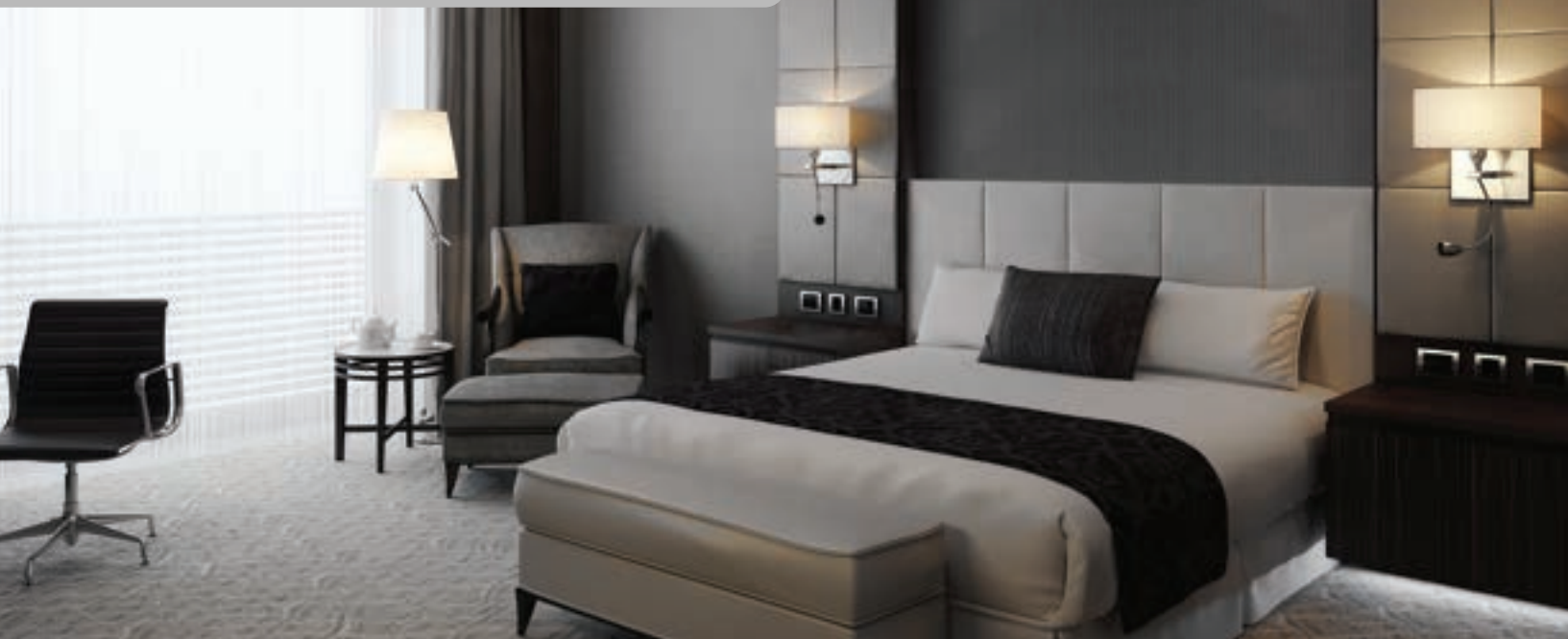

PR600

Profilo in Alluminio per installazioni su parete o soffitto verniciato bianco.

Aluminium profile for wall or ceiling mounting, white painted



CODICE	LUNGHEZZA	COLORE	LISTINO
PR600/BI	2 MT	Bianco	70 €

**Può dissipare fino a 30 w/mt**  Elimina l'effetto puntinato (vedi pag. 118)  
Power dissipation up to 30 w/mt *Eliminate the dotted effect (see page 118)*

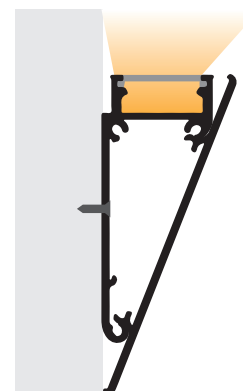
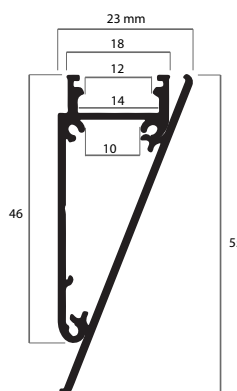

ACCESSORI - ACCESSORIES



**EN600/BI** - € 2  
Tappo chiuso  
Closed end cap

**CO600/BI** - € 32  
Connettore angolo 90° bianco con staffe per il fissaggio  
White 90° connector with attachment brackets.



**PR910** - € 10,5  
Schermo opaco 2 mt  
White cover 2 mt

**PR910/3** - € 17  
3 mt

**PR910/10** - € 55  
10 mt



**PR912** - € 16  
Schermo opaco ad arco  
Arched white cover



**PR900** - € 9  
Schermo trasparente 2 mt  
Transparent cover 2 mt

**PR900/3** - € 13  
Schermo trasparente 3 mt



**PR910/NE** - € 17  
Schermo nero 2 mt  
Black cover 2 mt



PROFILO IN ALLUMINIO  
DA PARETE  
WALL ALUMINUM PROFILES



PR650

CODICE	LUNGHEZZA	COLORE	LISTINO
PR650	2 MT	Silver	40 €
PR650/BI	2 MT	Bianco	47,50 €
PR650/NE	2 MT	Nero	47,50 €



**Può dissipare fino a 2x16 w/mt**  Elimina l'effetto puntinato (vedi pag. 118)  
*Power dissipation up to 2x16 w/mt* *Eliminate the dotted effect (see page 118)*

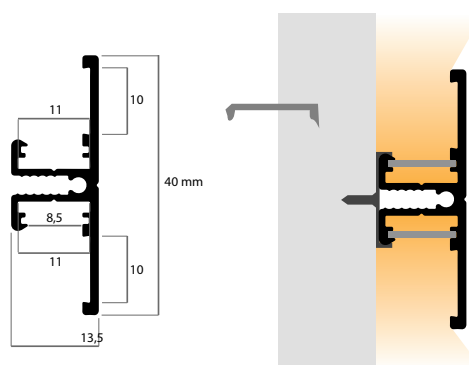

ACCESSORI - ACCESSORIES



**EN000** - € 1  
Staffa per profilo  
*Flexible mounting plate*



**EN650** - Silver - € 2  
Tappo chiuso  
*Closed end cap*  
**EN650/NE** - Nero / Black  
**EN650/BI** - Bianco / White



**PR851** - € 6  
Schermo opaco 2 mt  
*White cover 2 mt*

PROFILO IN ALLUMINIO  
SUPERFICI CURVE  
ALUMINUM PROFILE FOR CURVED SURFACES

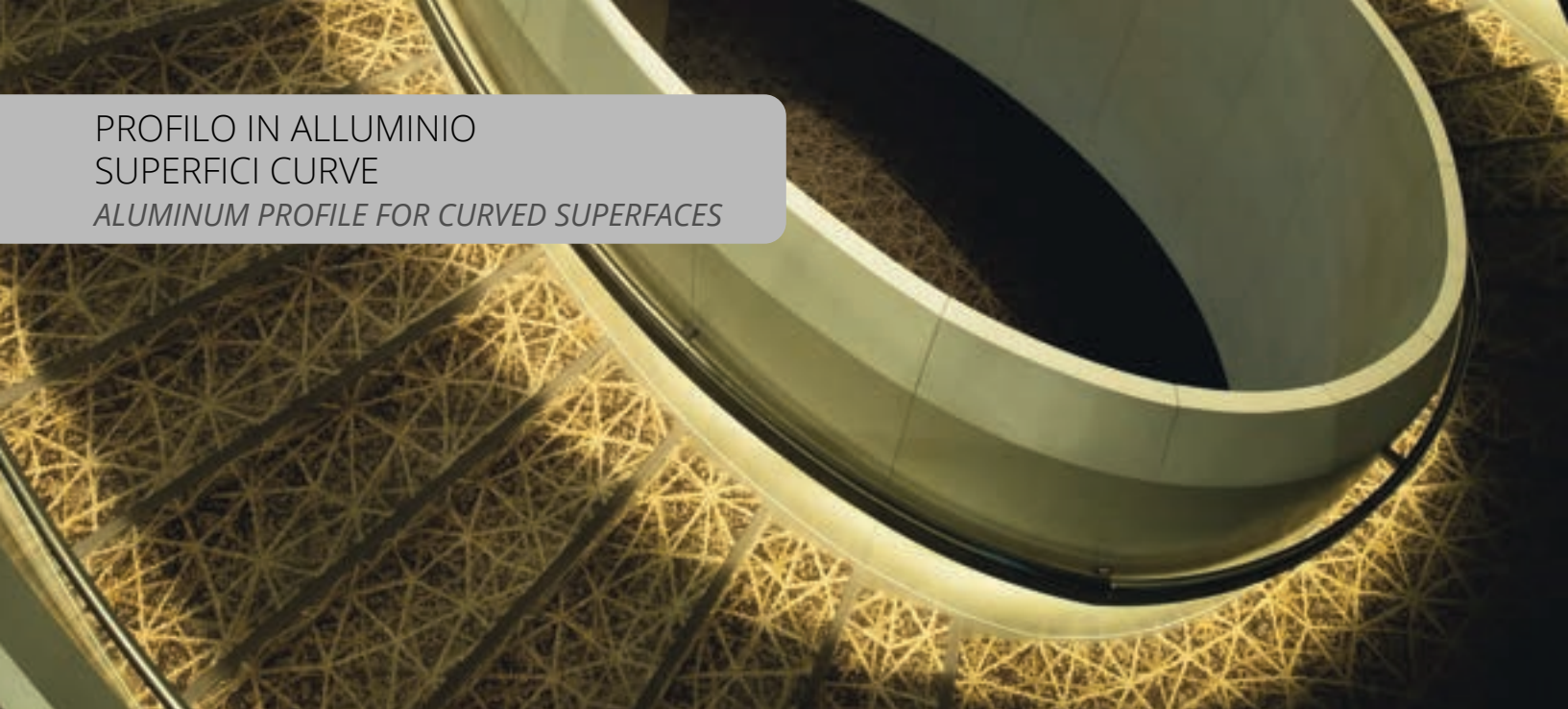

Profilo in alluminio silver curvabile, ideale per archi o soffitti a volta, possibilità di montare due differenti tipi di schermo.

Silver aluminum curve profile for arcs and vaulted ceilings. It can be also possible to put on two different types of screen.

**PR410**



CODICE	LUNGHEZZA	COLORE	LISTINO
PR410	2 MT	Silver	10 €

Confezioni da 10pz | Packs of 10pcs

**Può dissipare fino a 16 w/mt**  
Power dissipation up to 16 w/mt

... Elimina l'effetto puntinato (vedi pag. 118)  
Eliminate the dotted effect (see page 118)

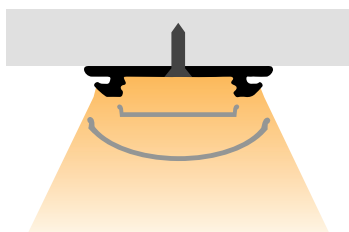
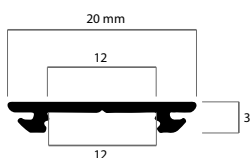

GUARDA IL VIDEO



See the video

ACCESSORI - ACCESSORIES



**EN004** - € 2  
Staffa per profilo  
Profile bracket



**EN410** - € 1  
Tappo per schermo basso  
Low screen cap



**EN411** - € 1  
Tappo per schermo alto  
High screen cap



**PR910** - € 10,5  
Schermo opaco 2 mt  
White cover 2 mt  
**PR910/3** - € 17  
3 mt  
**PR910/10** - € 55  
10 mt

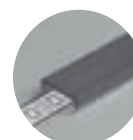

**PR910/NE** - € 17  
Schermo nero 2 mt  
Black cover 2 mt



**PR912** - € 16  
Schermo opaco ad arco 2mt  
Arched white cover 2 mt



**PR900** - € 9  
Schermo trasparente 2 mt  
Transparent cover 2 mt  
**PR900/3** - € 13  
Schermo trasparente 3 mt  
Transparent cover 3 mt



BANDELLE DISSIPATRICI  
PER SUPERFICI PIANE E CURVE  
DISSIPATOR BANDS FOR FLAT AND CURVED SURFACES



Bandelle flessibili in alluminio anodizzato grigio, spessore 1,2 mm adatte a superfici piane o curve grazie alla loro flessibilità.

Flexible strips in gray anodized aluminum, 1.2 mm thick, suitable for flat or curved surfaces thanks to their flexibility.

**PR002**



CODICE	LUNGHEZZA	COLORE	LISTINO
PR002	2 MT	Silver	7 €

**Può dissipare fino a 12 w/mt**  
Power dissipation up to 12 w/mt

\*Confezioni da 10pz | \*Packs of 10pcs

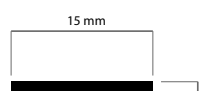

**PR410**



CODICE	LUNGHEZZA	COLORE	LISTINO
PR410	2 MT	Silver	10 €

**Può dissipare fino a 16 w/mt**  
Power dissipation up to 16 w/mt

\*Confezioni da 10pz  
\*Packs of 10pcs

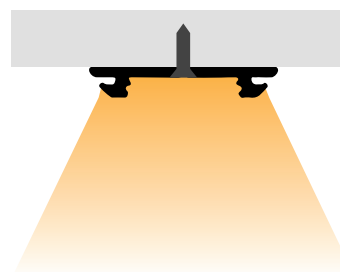
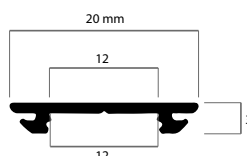

ACCESSORI - ACCESSORIES



**EN004** - 2 €  
Staffa per profilo  
Profile bracket

LINE **IN**

# PROFILI IN CARTONGESSO

*PROFILES EMBEDDED  
IN A PLASTERBOARD*

Linea di profili in alluminio pre-incassati per applicazioni interne.

Proteggi il profilo e installa con estrema facilità.

*Line of pre-recessed aluminum profiles for internal applications.*

*Protect the profile and install with extreme ease.*



GUARDA IL VIDEO



See the video

PROFILI IN ALLUMINIO  
IN CARTONGESSO  
ALUMINUM PROFILES IN PLASTERBOARD



Profilo miniaturizzato PR105 incassato in lastra di cartongesso, spessore 13 mm, per installazioni ad incasso a scomparsa

PR105 miniaturized profile embedded in a sheet of plasterboard, thickness 13 mm, for trimless recessed installations

**PG105**

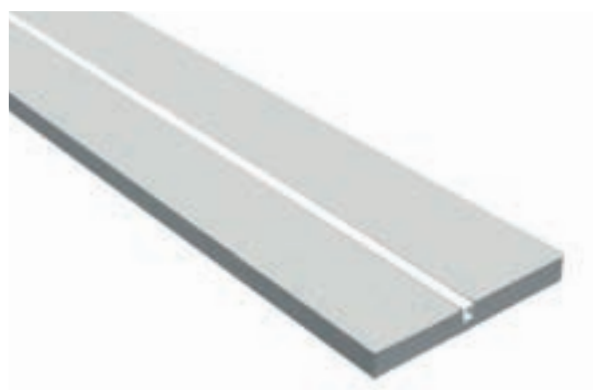

CODICE	LUNGHEZZA	COLORE	LISTINO
PG105	2 MT	Cartongesso	95,50 €

Imballo minimo 10 pz | Minimum evadable packaging 10 pcs

**Può dissipare fino a 16 w/mt** Elimina l'effetto puntinato (vedi pag. 118)  
Power dissipation up to 16 w/mt Eliminate the dotted effect (see page 118)

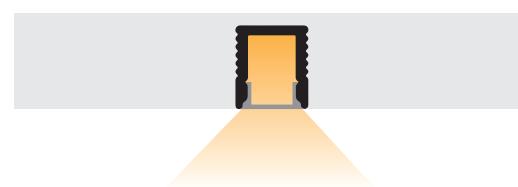
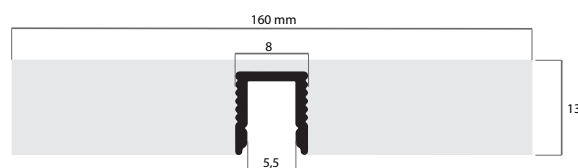

ACCESSORI - ACCESSORIES

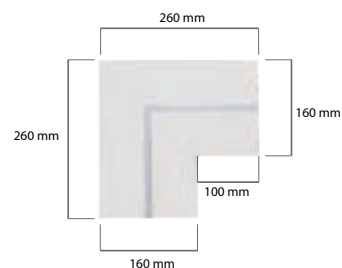

**COG105** - € 52

Connettore angolo 90° in cartongesso.  
Base 160 mm x altezza 260 mm x spessore 13 mm

Plasterboard 90° angle connector.  
Base 160 mm x height 260 mm x thickness 13 mm



**EN105** - € 1  
Tappo chiuso grigio  
Gray closed end cap



**EN105/1** - € 1  
Tappo forato grigio  
Gray end cap with hole

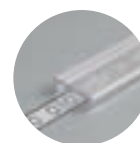

**PR905** - € 8,50  
Schermo trasparente 2 mt  
SchermiTransparent cover 2 mt



**PR915** - € 11,50  
Schermo opaco 2 mt  
White cover 2 mt

PROFILI IN ALLUMINIO  
IN CARTONGESSO  
ALUMINUM PROFILES IN PLASTERBOARD

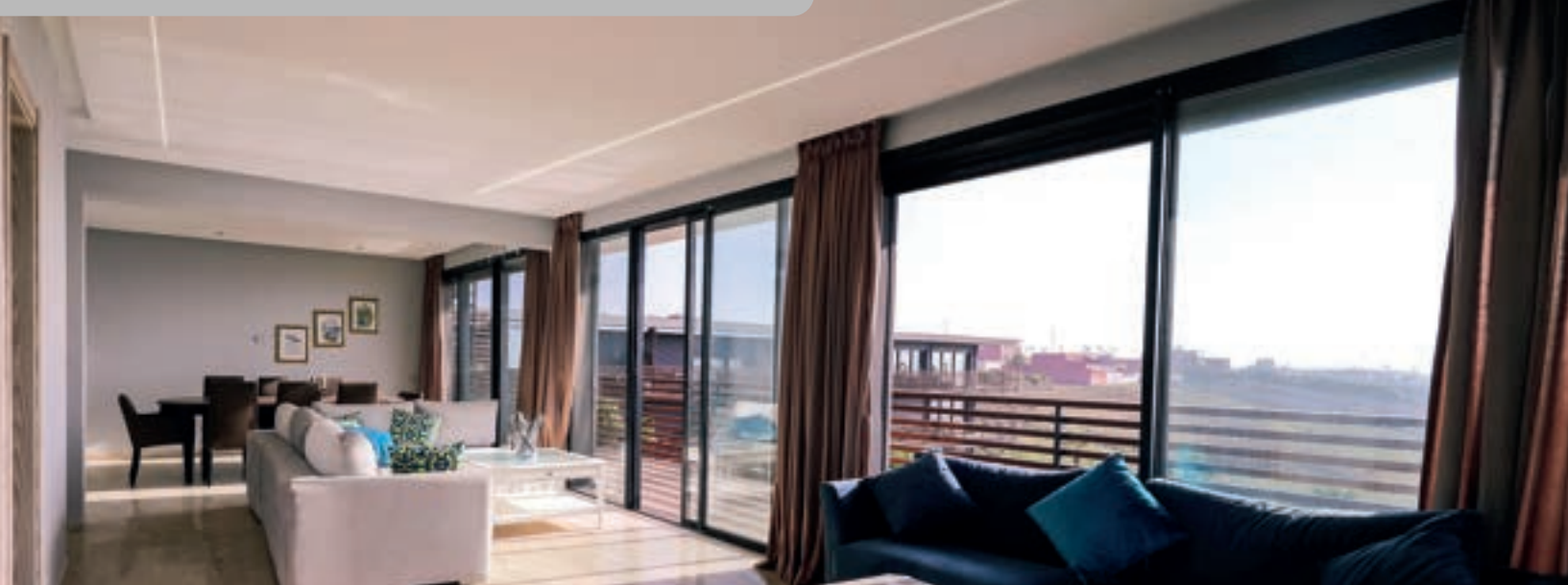

**PG110**

Profilo in alluminio PR110 incassato in lastra di cartongesso, spessore 13mm, per installazioni ad incasso a scomparsa

PR110 aluminum profile embedded in a plasterboard sheet, thickness 13 mm, for trimless recessed installations



CODICE	LUNGHEZZA	COLORE	LISTINO
PG110	2 MT	Cartongesso	95,50 €

Imballo minimo 10 pz | Minimum evadable packaging 10 pcs

**Può dissipare fino a 20 w/mt**  
Power dissipation up to 20 w/mt

... Elimina l'effetto puntinato (vedi pag. 118)  
Eliminate the dotted effect (see page 118)

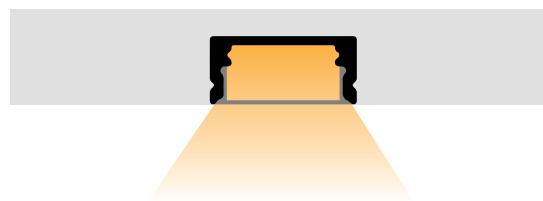
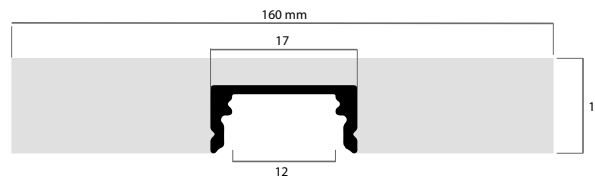

ACCESSORI - ACCESSORIES

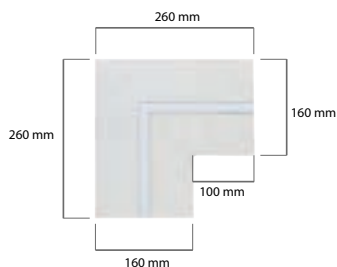

**COG110** - € 52

Connettore angolo 90° in cartongesso.  
Base 160 mm x altezza 260 mm x spessore 13 mm

Plasterboard 90° angle connector.  
Base 160 mm x height 260 mm x thickness 13 mm



**EN110** - € 1  
Tappo chiuso grigio  
Gray closed end cap



**EN110/1** - € 1  
Tappo forato grigio  
Gray end cap with hole



**PR990** - € 9  
Schermo trasparente 2 mt  
Transparent cover 2 mt



**PR991** - € 10,50  
Schermo opaco 2 mt  
White cover 2 mt





LINE **IN**



LINE **IN**  
GLASROC®

## PROFILO IN ALLUMINIO IN GLASROC® PER ESTERNI

### *OUTDOOR ALUMINUM PROFILE IN GLASROC®*

Glasroc® è la lastra in gesso fibrorinforzato specifica per applicazioni esterne. La lastra Glasroc® è formata da un nucleo in gesso contenente additivi speciali, che la rendono resistente all'umidità e alla muffa.

È armata su entrambe le facce da tessuto in fibra di vetro (glass mat) con rivestimento resistente ai raggi UV, queste caratteristiche permettono alte prestazioni in ambienti umidi.

Glasroc®, priva di cellulosa, possiede un'elevata resistenza alla formazione di muffe, ed è indicata per essere installata in esterno e in ambienti molto umidi. I rivestimenti in fibra di vetro sono coesi con il nucleo in gesso, creando un pannello altamente resistente e solido, dall'eccezionale integrità.

Profilo in alluminio PR110 incassato in lastra di Glasroc®, per installazioni esterne ad incasso a scomparsa.  
 PR110 aluminum profile embedded in a Glasroc® sheet, for outdoor trimless recessed installations.

## PG110/GR



CODICE	LUNGHEZZA	COLORE	LISTINO
PG110/GR	2 MT	Cartongesso	201,50 €

Imballo minimo 10 pz | *Minimum evadable packaging 10 pcs*

**Può dissipare fino a 20 w/mt**  
*Power dissipation up to 20 w/mt*

... Elimina l'effetto puntinato (vedi pag. 118)  
*Eliminate the dotted effect (see page 118)*

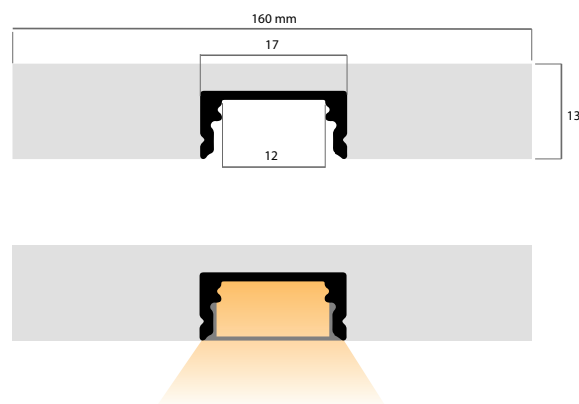

## ACCESSORI - ACCESSORIES

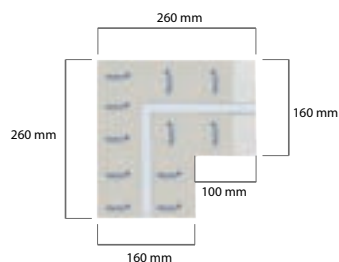

**COG110/GR** - € 95,50  
 Connettore angolo 90° in Glasroc®.  
 Base 160 mm x altezza 260 mm x spessore 13 mm

*Glasroc® 90° angle connector.*  
*Base 160 mm x height 260 mm x thickness 13 mm*



**EN110** - € 1  
 Tappo chiuso grigio  
*Gray closed end cap*



**EN110/1** - € 1  
 Tappo forato grigio  
*Gray end cap with hole*

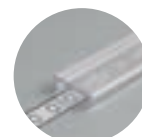

**PR990** - € 9  
 Schermo trasparente 2 mt  
*Transparent cover 2 mt*

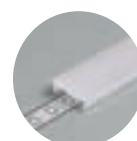

**PR991** - € 10,50  
 Schermo opaco 2 mt  
*White cover 2 mt*

PER LA TUA CONFIGURAZIONE  
TI BASTERÀ SCEGLIERE:

FOR YOUR CONFIGURATION YOU JUST CHOOSE:



**STRIP LED**  
LED STRIP



**COLORE LED**  
LED COLORED



**PROFILO**  
PROFILE



**LUNGHEZZA**  
LENGHT



**ACCENSIONE**  
TYPE IGNITION

## BARRE LED



ACCENSIONE



### ACCENSIONE ON/OFF

La barra LED si potrà accendere e spegnere tramite interruttore a parete o presa comandata.

### INTERRUTTORE TOUCH

Sfiora il sensore in prossimità del LED colore blu e accendi e spegni la barra LED touch. Tieni premuto e regola l'intensità luminosa.

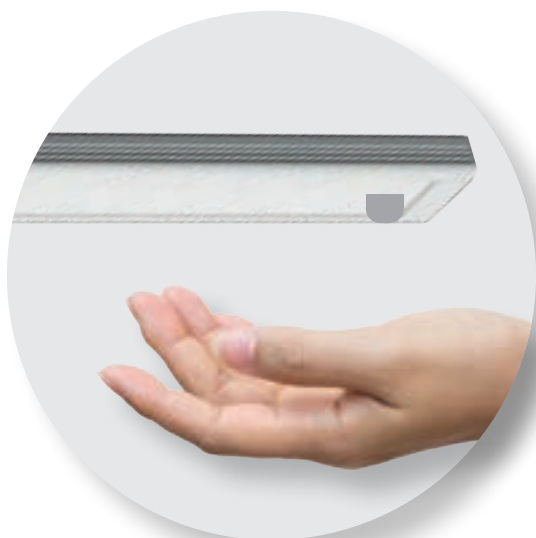

### SENSORE DI PROSSIMITÀ

La barra LED si accenderà solo quando ci sarà un movimento in prossimità del sensore.

## BARRA LED LED BAR



Barra led luminosa in alluminio anodizzato con interruttore touch integrato, disponibile in tre versioni:

*LED light bar in anodized aluminum with integrated touch switch, available in three versions:*

- NT - senza interruttore touch
- Dimmerabile - sensore sensibile allo sfioramento per regolare la luminosità della barra.
- Sensore Infrarossi - il timer integrato la spegne dopo 30 secondi se non viene rilevato nessun movimento.
- *Without touch switch*
- *Touch switch to control the bar brightness*
- *IR touch switch - incorporated timer to turn off the led bar after 30 second without movement*



Alimentatore incluso  
in tutti i modelli  
*Power supply included  
with all types*

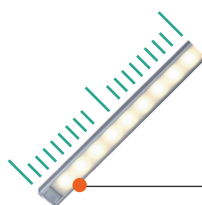

Lunghezza e tipo di profilo  
sono customizzabili  
*Personalized length  
and profile type*

CODICE	DESCRIZIONE	K	COLORE	LUNGHEZZA	POTENZA	LISTINO
BL100010/LBC	BARRA TOUCH DIMMERABILE	3000 K	Silver	1 MT	14 W - 12 V	95 €
BL100010/LBN	BARRA TOUCH DIMMERABILE	4000 K	Silver	1 MT	14 W - 12 V	95 €
BL100010/LBI	BARRA TOUCH DIMMERABILE	6000 K	Silver	1 MT	14 W - 12 V	95 €
BL500210/LBC	BARRA C/SENSORE DI PRESENZA IR	3000 K	Silver	1 MT	14 W - 12 V	100 €
BL500210/LBN	BARRA C/SENSORE DI PRESENZA IR	4000 K	Silver	1 MT	14 W - 12 V	100 €
BL500210/LBI	BARRA C/SENSORE DI PRESENZA IR	6000 K	Silver	1 MT	14 W - 12 V	100 €
BL100110/LBC	BARRA SENZA INTERRUTTORE	3000 K	Silver	1 MT	14 W - 12 V	75 €
BL100110/LBN	BARRA SENZA INTERRUTTORE	4000 K	Silver	1 MT	14 W - 12 V	75 €
BL100110/LBI	BARRA SENZA INTERRUTTORE	6000 K	Silver	1 MT	14 W - 12 V	75 €
BL100011/LBC	BARRA TOUCH DIMMERABILE BIANCO	3000 K	Bianco	1 MT	14 W - 12 V	100 €
BL100011/LBN	BARRA TOUCH DIMMERABILE BIANCO	4000 K	Bianco	1 MT	14 W - 12 V	100 €
BL100011/LBI	BARRA TOUCH DIMMERABILE BIANCO	6000 K	Bianco	1 MT	14 W - 12 V	100 €
BL100012/LBC	BARRA TOUCH DIMMERABILE NERO	3000 K	Nero	1 MT	14 W - 12 V	100 €
BL100012/LBN	BARRA TOUCH DIMMERABILE NERO	4000 K	Nero	1 MT	14 W - 12 V	100 €
BL100012/LBI	BARRA TOUCH DIMMERABILE NERO	6000 K	Nero	1 MT	14 W - 12 V	100 €

BARRA LED RESINATA IP68  
IP68 RESIN COATED LED BAR



BARRA LED  
RESINATA  
IP68

- Barra LED resinata in alluminio
- Grado di Protezione IP68
- Rivestimento in resina poliuretanic  
opalina vetrificata per una migliore diffusione  
della luce con trattamento anti raggi UV
- *LED resin bar in aluminum*
- *IP68 protection degree/level*
- *Poliuretanic opaline resin vitrified cover for better  
light diffusion, UV resistant*

CODICE	DESCRIZIONE	K	COLORE	LUNGHEZZA	POTENZA	LISITNO
BR1010LBC	BARRA RESINATA IP68	3000 K	Silver	1 MT	20 W - 24 V	135 €
BR1010LBN	BARRA RESINATA IP68	4000 K	Silver	1 MT	20 W - 24 V	135 €
BR1010LBI	BARRA RESINATA IP68	6000 K	Silver	1 MT	20 W - 24 V	135 €



# TRASFORMATORI *POWER SUPPLY*

COMPATTI  
48 V  
IP67  
CLASSE II



## TRASFORMATORE 25W



Dimensioni: 84 x 58 x h 32 mm

CODICE	CONSUMO	TENSIONE	IP	PREZZO
TR2425	25W	24V	20	25 €
TR1225	25W	12V	20	25 €

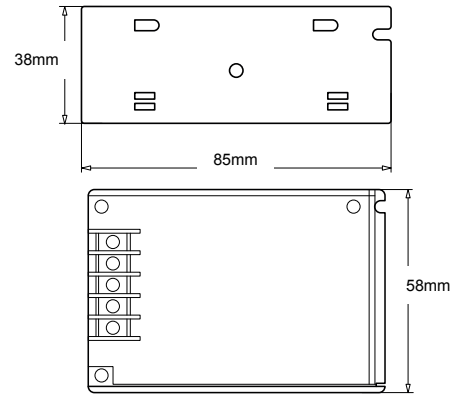

## TRASFORMATORE 40W



Dimensioni: 125,5 x 46,8 x h 32,5 mm

CODICE	CONSUMO	TENSIONE	IP	PREZZO
TR2440	40W	24V	20	32 €
TR1240	40W	12V	20	32 €

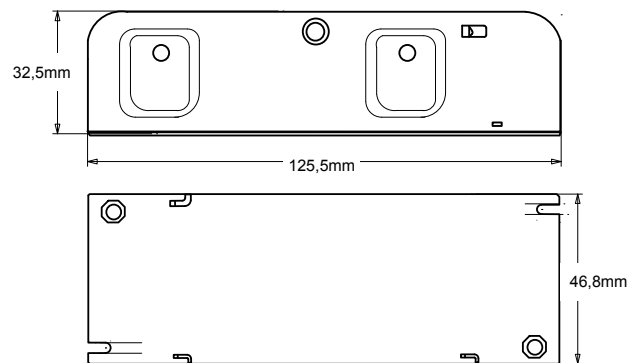

## TRASFORMATORE 80W



Dimensioni: 161 x 40,4 x h 32,5 mm

CODICE	CONSUMO	TENSIONE	IP	PREZZO
TR2480	80W	24V	20	37 €
TR1280	80W	12V	20	37 €

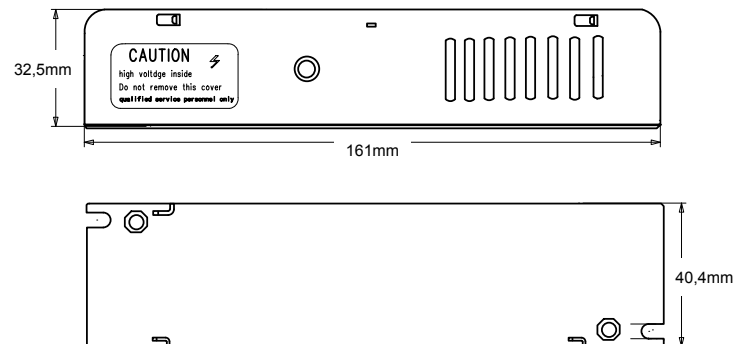

## TRASFORMATORE 100W



Dimensioni: 188,6 x 46,2 x h 34,4 mm

CODICE	CONSUMO	TENSIONE	IP	PREZZO
TR24100	100W	24V	20	42,50 €
TR12100	100W	12V	20	42,50 €

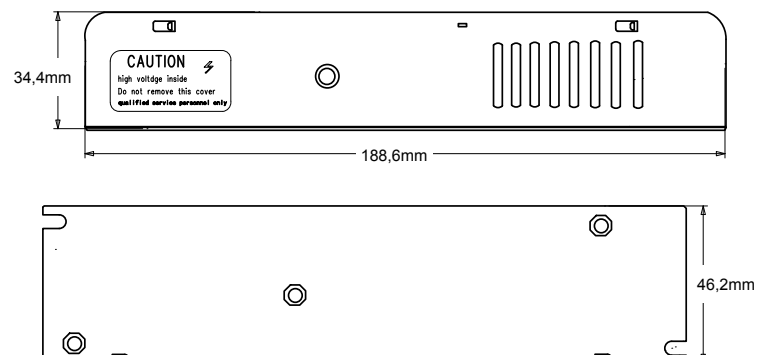

## TRASFORMATORE 150W



Dimensioni: 166,3 x 59 x h 30 mm

CODICE	CONSUMO	TENSIONE	IP	PREZZO
TR24150	150W	24V	20	50 €
TR12150	150W	12V	20	50 €

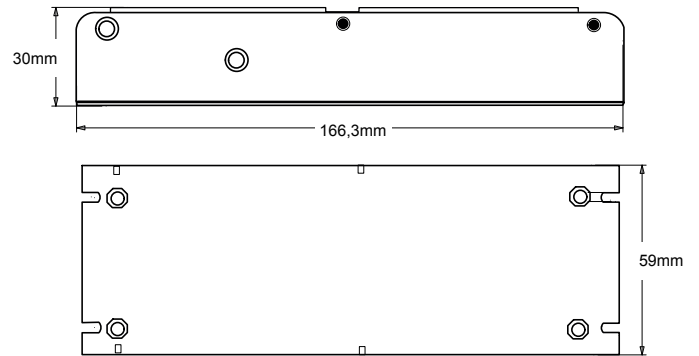

## TRASFORMATORE 200W



Dimensioni: 166,3 x 59 x h 30 mm

CODICE	CONSUMO	TENSIONE	IP	PREZZO
TR24200	200W	24V	20	55 €
TR12200	200W	12V	20	55 €

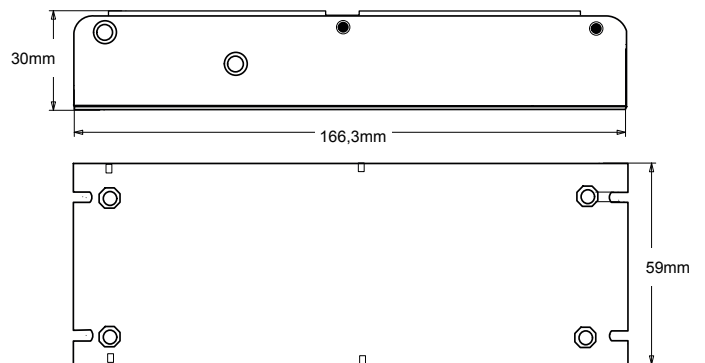

## TRASFORMATORE 250W



Dimensioni: 223,4 x 66,9 x h 39,9 mm

CODICE	CONSUMO	TENSIONE	IP	PREZZO
TR24250	250W	24V	20	64 €
TR12250	250W	12V	20	64 €

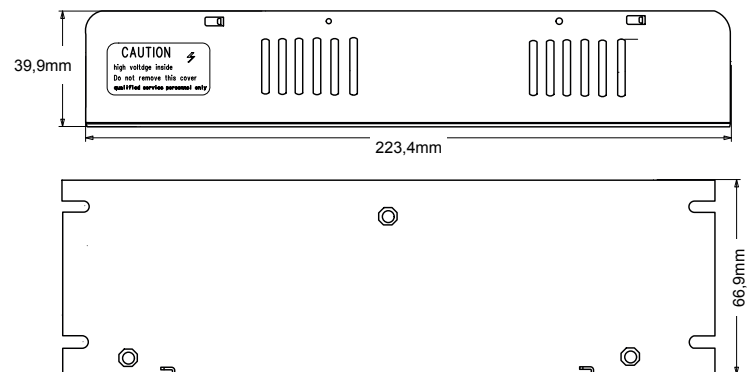

## TRASFORMATORE 360W



Dimensioni: 223,4 x 66,9 x h 39,9 mm

CODICE	CONSUMO	TENSIONE	IP	PREZZO
TR24360	360W	24V	20	80 €
TR12360	360W	12V	20	80 €

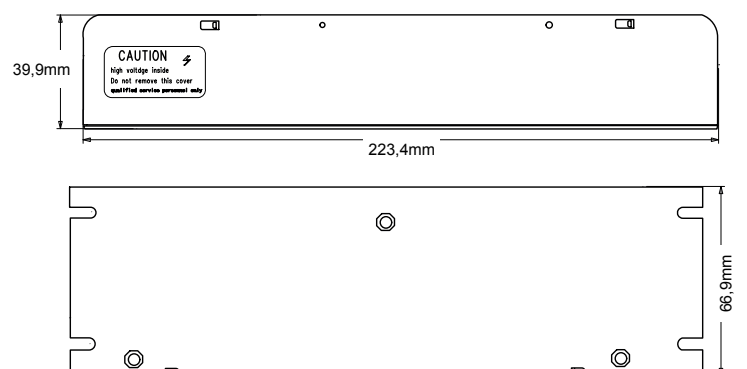

## TRASFORMATORI 48V

### POWER SUPPLY 48V



Dimensioni: 188,6 x 46,2 x h 34,4 mm

CODICE	CONSUMO	TENSIONE	IP	LISTINO
TR48100	100W	48V	20	62 €

### TRASFORMATORE 48VDC 100W

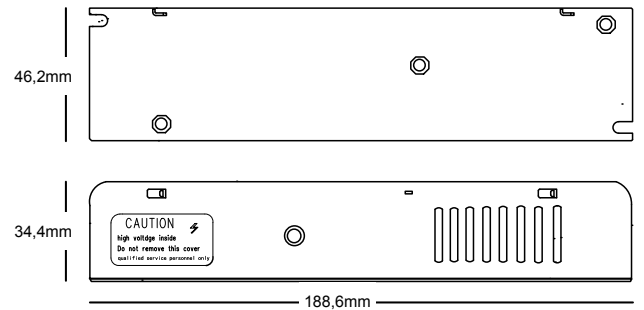

Dimensioni: 223,4 x 66,9 x h 39,9 mm

CODICE	CONSUMO	TENSIONE	IP	LISTINO
TR48200	200W	48V	20	85 €

### TRASFORMATORE 48VDC 200W

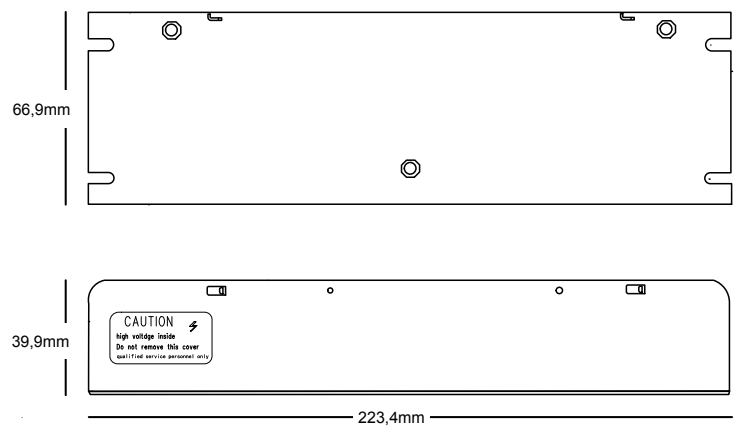

Dimensioni: 215 x 114 x h 50 mm

CODICE	CONSUMO	TENSIONE	IP	LISTINO
TR48360	360W	48V	20	135 €

### TRASFORMATORE 48VDC 360W

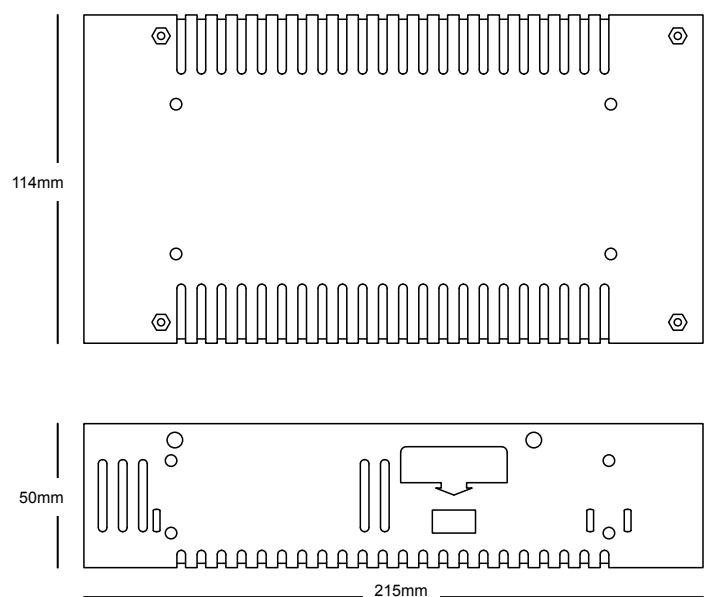

## TRASFORMATORI IP67

### POWER SUPPLY IP67

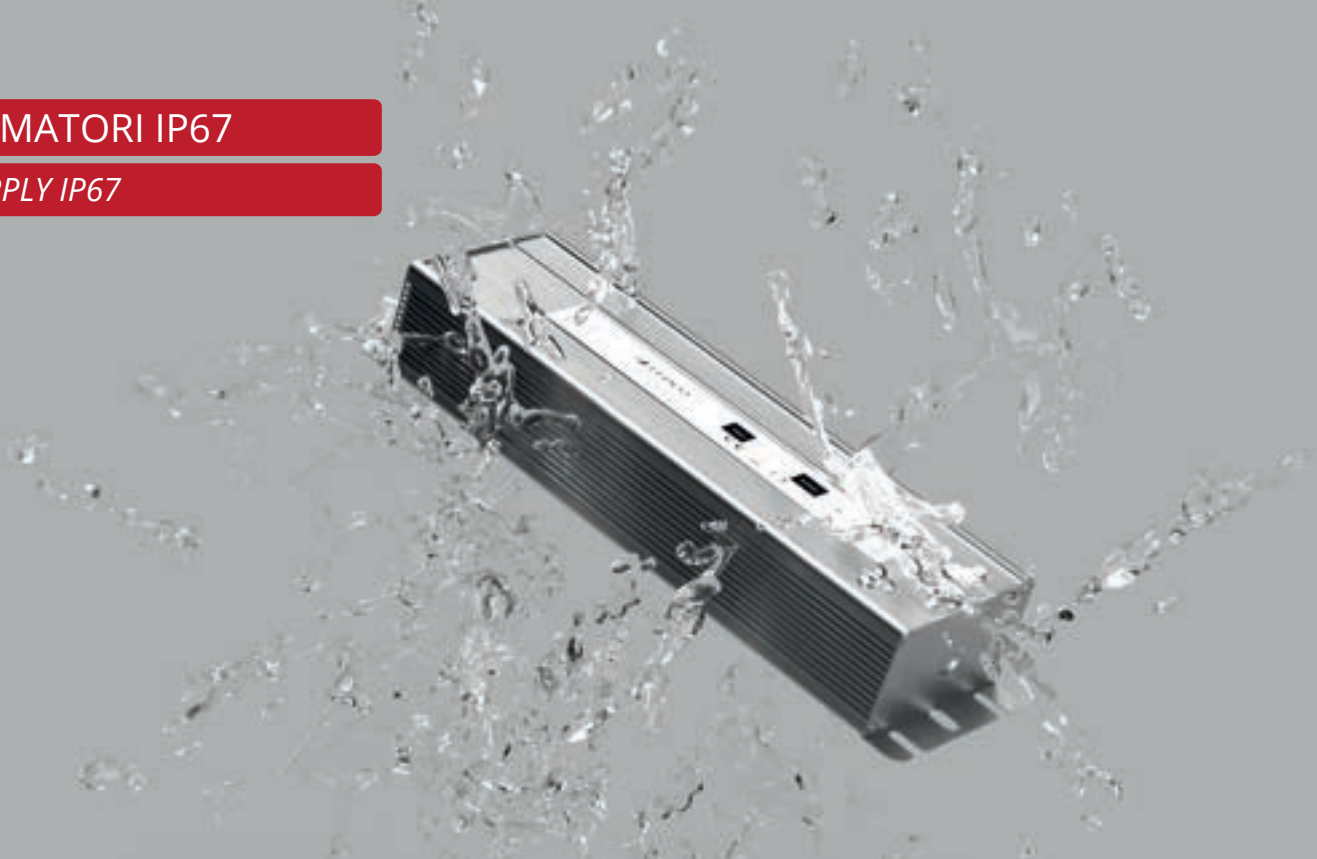

Dimensioni: 218 x 30 x h 20 mm

CODICE	CONSUMO	TENSIONE	IP	LISTINO
TR2430/67	30W	24V	67	26,50 €

## TRASFORMATORE IP67 30W



Dimensioni: 208 x 72 x h 45 mm

CODICE	CONSUMO	TENSIONE	IP	LISTINO
TR2460/67	60W	24V	67	51 €

## TRASFORMATORE IP67 60W

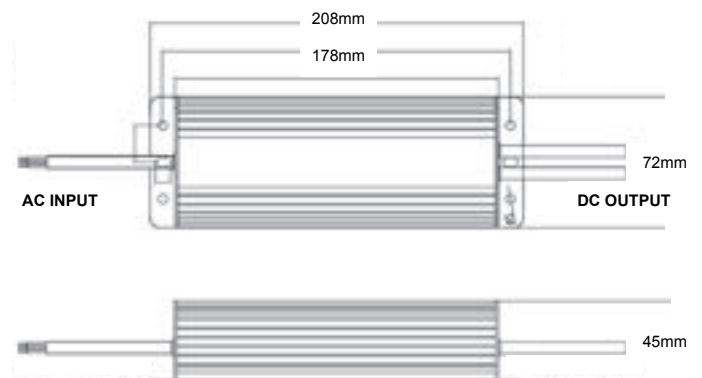



Dimensioni: 240 x 72 x h 45 mm

CODICE	CONSUMO	TENSIONE	IP	LISTINO
TR24100/67	100W	24V	67	80 €

## TRASFORMATORE IP67 100W

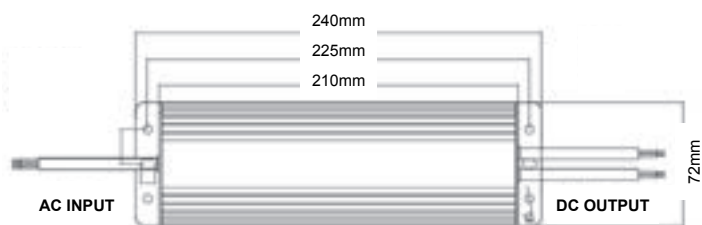

Dimensioni: 240 x 72 x h 45 mm

CODICE	CONSUMO	TENSIONE	IP	LISTINO
TR24150/67	150W	24V	67	111,50 €

## TRASFORMATORE IP67 150W



Dimensioni: 230 x 120 x h 54 mm

CODICE	CONSUMO	TENSIONE	IP	LISTINO
TR24200/67	200W	24V	67	132,50 €

## TRASFORMATORE IP67 200W

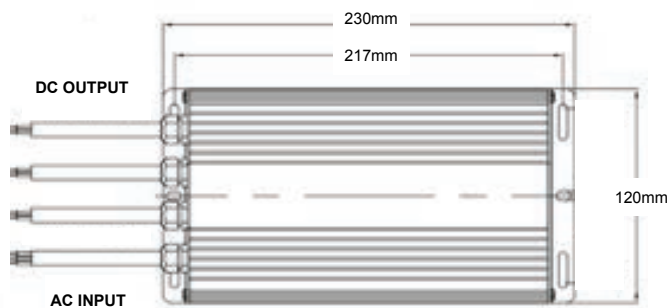

## TRASFORMATORI 48V - IP67

### POWER SUPPLY 48V - IP67



Dimensioni: 180 x 50 x h 20 mm

CODICE	CONSUMO	TENSIONE	IP	LISTINO
TR48100/67	100W	48V	67	90 €

## TRASFORMATORE 48V IP67 100W

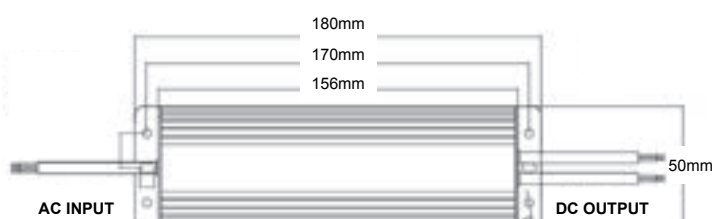

Dimensioni: 240 x 72 x h 45 mm

CODICE	CONSUMO	TENSIONE	IP	LISTINO
TR48200/67	200W	48V	67	170 €

## TRASFORMATORE 48V IP67 200W

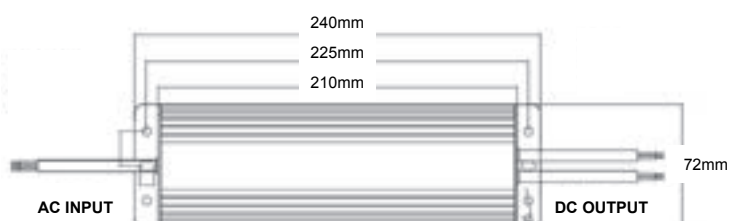

Dimensioni: 185 x 120 x h 55 mm

CODICE	CONSUMO	TENSIONE	IP	LISTINO
TR48300/67	300W	48V	67	244 €

## TRASFORMATORE 48V IP67 300W

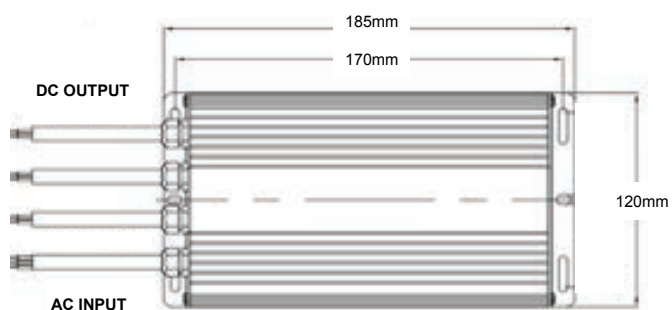



Dimensioni: 115,2 x 45 x h 30 mm

CODICE	CONSUMO	TENSIONE	IP	LISTINO
TR2424/CL2	24W	24V	20	28 €

## TRASFORMATORE CLASSE II 24W

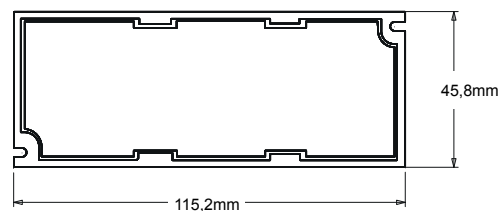

Dimensioni: 165 x 45 x h 30 mm

CODICE	CONSUMO	TENSIONE	IP	LISTINO
TR2450/CL2	50W	24V	20	38 €

## TRASFORMATORE CLASSE II 50W

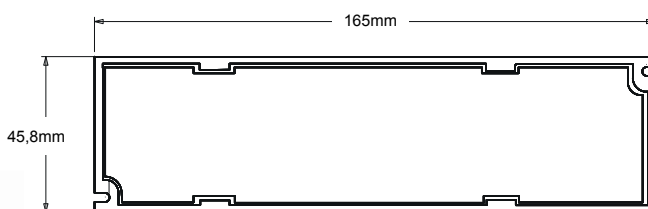
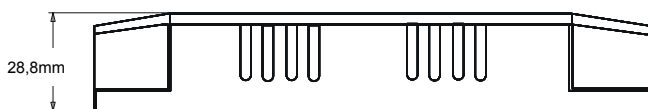

Dimensioni: 165 x 45 x h 30 mm

CODICE	CONSUMO	TENSIONE	IP	LISTINO
TR2480/CL2	80W	24V	20	48 €

## TRASFORMATORE CLASSE II 80W

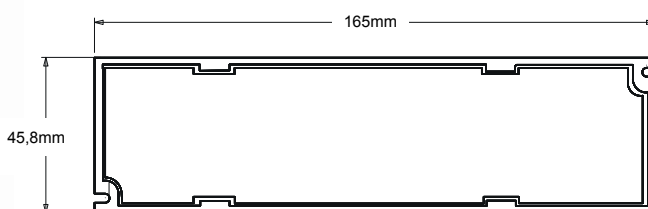
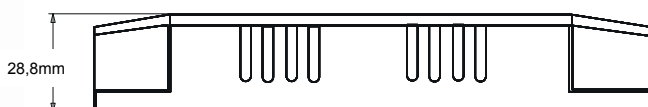

Dimensioni: 166 x 47 x h 30 mm

CODICE	CONSUMO	TENSIONE	IP	LISTINO
TR24100/CL2	100W	24V	20	69 €

## TRASFORMATORE CLASSE II 100W

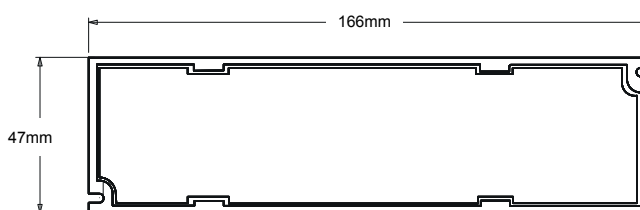
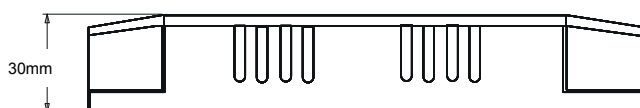

# TRASFORMATORE SLIM CLASSE II 100W

SLIM POWER SUPPLY CLASS II 100W

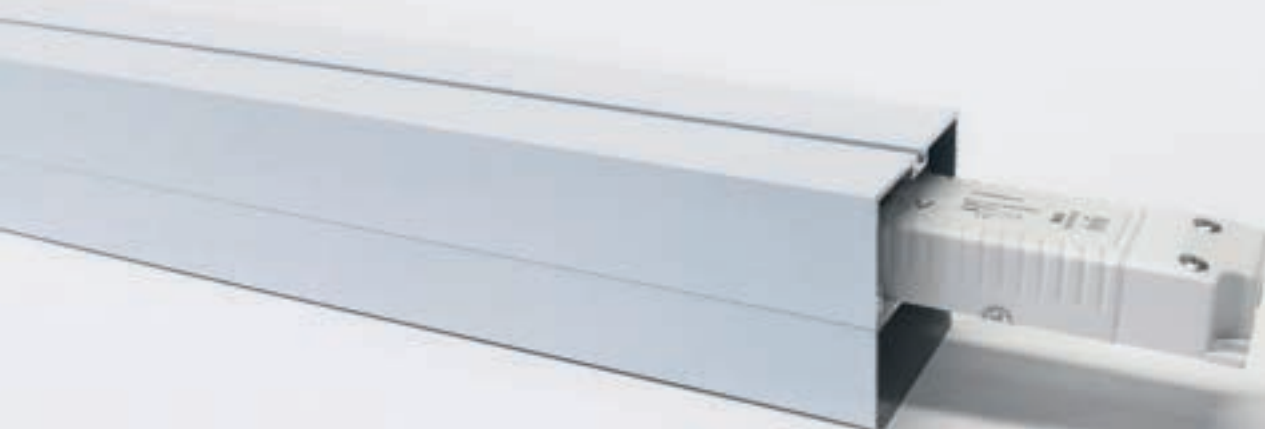

Dimensioni: 310 x 30 x h 18 mm

CODICE	TIPOLOGIA	CONSUMO	TENSIONE	IP	LISTINO
TR24100/CL2/S	TRASFORMATORE SLIM CLASSE II	100W	24V	20	132,50 €

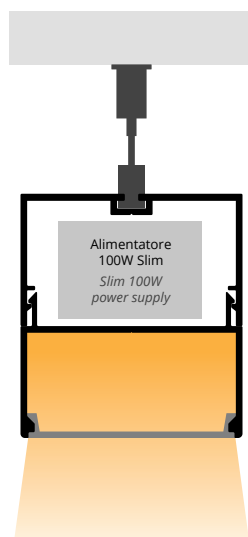
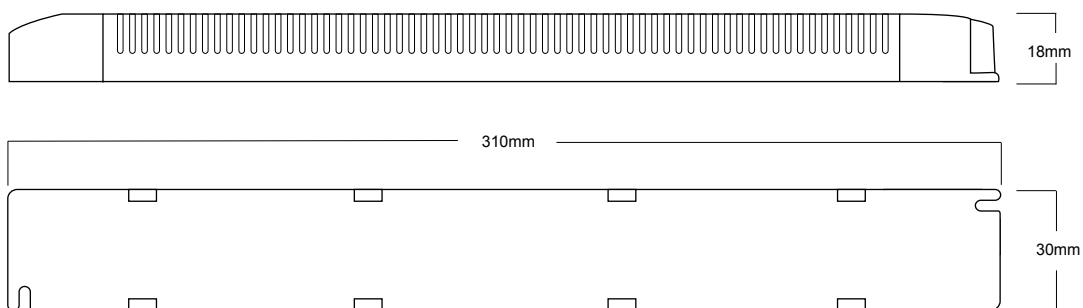





Dimensioni: 205 x 70 x h 36 mm

CODICE	CONSUMO	TENSIONE	IP	LISTINO
TR24150/CL2	150W	24V	20	100 €

## TRASFORMATORE CLASSE II 150W

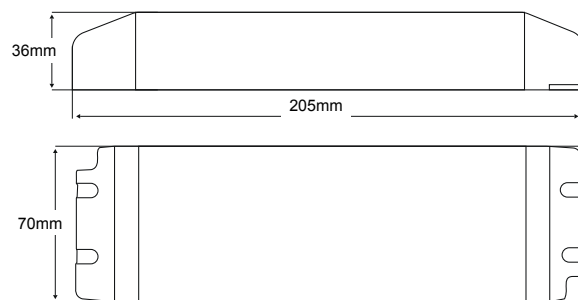

## TRASFORMATORE CLASSE II 180W



Dimensioni: 340 x 50 x h 36 mm

CODICE	CONSUMO	TENSIONE	IP	LISTINO
TR24180/CL2	180W	24V	20	100 €

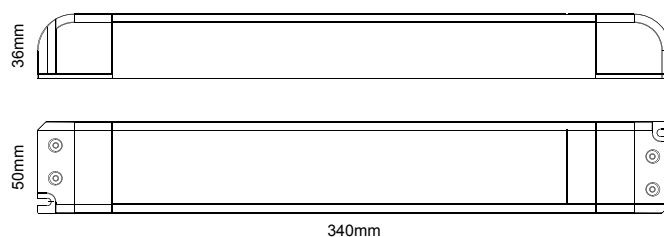

## TRASFORMATORE CLASSE II 200W



Dimensioni: 205 x 70 x h 36 mm

CODICE	CONSUMO	TENSIONE	IP	LISTINO
TR24200/CL2	200W	24V	20	127 €

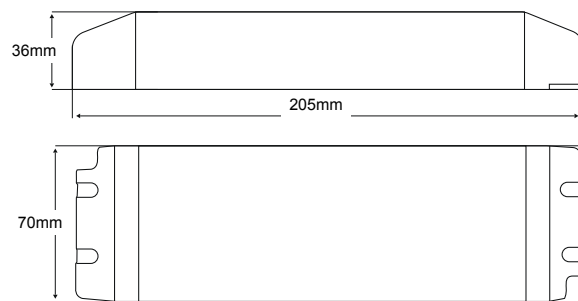

## TRASFORMATORE CLASSE II 250W



Dimensioni: 205 x 70 x h 36 mm

CODICE	CONSUMO	TENSIONE	IP	LISTINO
TR24250/CL2	250W	24V	20	145 €

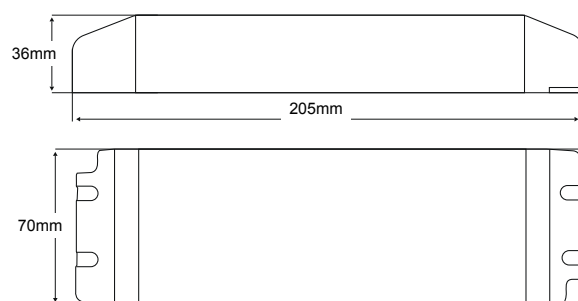

# TRASFORMATORE DIMM. DALI 24V 200W

DIMMABLE DALI POWER SUPPLY 24V 200W



Trasformatore compatibile con strip LED 24V monocromatiche, RGB e RGB.W per controllo DALI. Dimmerabile anche tramite Push.

*DALI Power Supply for 24V monochromatic, RGB and RGB.W LED strips.  
Dimmable also with Push button.*



Dimensioni: 270 x 79 x h 39 mm

CODICE	TIPOLOGIA	CONSUMO	TENSIONE	IP	LISTINO
TR24200/D	TRASFORMATORE DALI	200W	24V	20	320 €

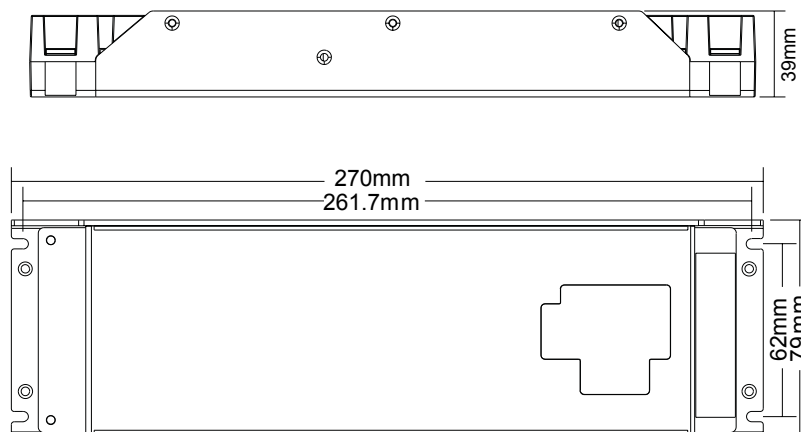



# CENTRALE BLUETOOTH MESH

La tecnologia bluetooth mesh permette la creazione di impianti multizona con il solo utilizzo del tuo smartphone

*The bluetooth mesh technology allows the creation of multizone systems with just the use of your smartphone*

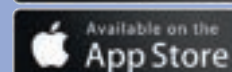



## CT580/BLE

Centralina bluetooth mesh gestibile con telecomando RF, push, app smartphone dedicata e assistenti vocali.

*Bluetooth mesh RGBW control unit*



### RE500 - € 105

Telecomando in radiofrequenza per controllo della centralina CT580/BLE

*Radio frequency remote control for control of the CT580/BLE control unit*



### CT580/BLE - € 170

- Con questa centralina potrai gestire e dimmerare tutti i tipi di strip LED 12V/24V/48V anche RGB, RGBW e Bianca Dinamica.
- Può essere controllata tramite il telecomando RF RE500, pulsante push, app smartphone con sistema IOS o ANDROID e con assistenti vocali Google Home e Alexa
- Uscita: 5CH / max 8A x CH

*• With this control unit you can manage and dim all types of 12V/24V/48V LED strips, including RGB and RGBW*

*• It can be controlled via the RE500 RF remote control, via smartphone app with IOS or ANDROID system or with the Google Home and Alexa voice assistants*

*• Output: 5CH / max 8A x CH*

## SCARICA L'APP



Scegli la modalità di accensione | Choose the control mode



**Telecomando**  
*Remote control*



**Pulsante push**  
*Push button*



**Smartphone**



**Assistenti vocali**  
*Voice assistants*



## DM500/BLE

Dimmer bluetooth mesh gestibile con telecomando RF, push, app smartphone dedicata e assistenti vocali.



**DM500/BLE** - € 120

- Con questo prodotto potrai dimmerare tutti i tipi di strip LED 12V/24V monocromatiche
- Può essere controllato tramite il telecomando RF RE500, pulsante push, app smartphone con sistema IOS o ANDROID e con assistenti vocali Google Home e Alexa
- Uscita: 1CH max 8A

- *With this product you can dim all types of 12V / 24V monochromatic LED strips*
- *Can be controlled via the RE500 RF remote control, push button, smartphone app with IOS or ANDROID system and with Google Home and Alexa voice assistants*
- *Output: 1CH max 8A*



**RE500** - € 105

Telecomando in radiofrequenza per controllo della centralina DM500/BLE

*Radio frequency remote control for control of the DM500/BLE control unit*

## SCARICA L'APP



Scegli la modalità di accensione | Choose the control mode



**Telecomando**  
Remote control



**Pulsante push**  
Push button



**Smartphone**



**Assistenti vocali**  
Voice assistants

## CENTRALE BLUETOOTH MESH BLUETOOTH MESH CONTROL UNIT



### CT360/B

Centralina bluetooth mesh  
*Mesh bluetooth control unit*

Con questa centralina puoi:

- Dimmerare strip tradizionali;
- Dimmerare bianco dinamico;
- Controllare RGB.

*With this control unit you can:*

- *Dimming traditional strips;*
- *Dynamic white dimming;*
- *Manage RGB.*

- Per il controllo occorre uno smartphone con sistema IOS o ANDROID
- Compatibile con tutti i tipi di strip led 12V /24V
- Uscita: max 5A x CH
- *A smartphone with IOS or ANDROID system is required for control*
- *Compatible with all types of 12V / 24V led strips*
- *Output: max 5A x CH*



CT360/B - € 100



**MULTIFUNZIONE  
MULTIFUNCTION**



Istruzioni  
configurazione  
*Instructions of  
configuration*



# SMART CONTROL WIFI MULTIFUNZIONE E MULTIZONA

## SMART CONTROL WIFI MULTIFUNCTION / MULTIZONE



### CT550 MULTIFUNZIONE/MULTIZONA PER STRIP 12V/24V

### MULTIFUNCTION / MULTIZONE FOR 12V / 24V STRIP



**CT550** - € 116,50  
Centrale Multifunzione  
Multifunctional control unit

Compatibile con:  
Compatible with:



Istruzioni configurazione  
Instructions of configuration

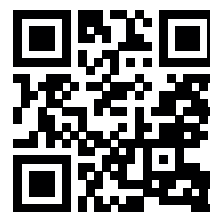

- Smart control wifi, per il controllo completo occorre uno smartphone con sistema IOS o ANDROID
- Compatibile tutti i tipi di strip led 12V / 24
- Con questa centralina puoi:
  - dimmerare strip tradizionali
  - dimmerare bianco dinamico
  - utilizzare RGB o RGB. white
- Uscita: 5\*4A

- *Smart control wifi, for complete control you need a smartphone with IOS or ANDROID system*
- *Compatible with all types of 12V / 24 led strips*
- *With this control unit you can:*
  - *dimming traditional strips*
  - *dimming dynamic white*
  - *use RGB or RGB. white*
- *Output: 5 \* 4A*

Istruzioni configurazione  
Instructions of configuration



**CT650** - € 110  
Centrale RGB data  
Control unit RGB data

- Smart control wifi, per il controllo completo occorre uno smartphone con sistema IOS o ANDROID
- Controllo di ogni singola zona
- Compatibile solo con strip RGB Dati

### CT650 SMART CONTROL PER STRIP RGB DATA SMART CONTROL FOR RGB DATA STRIP



- *Smart control wifi, for complete control you need a smartphone with IOS or ANDROID system*
- *Control of every single zone*
- *Compatible with RGB Data strips only*

# CENTRALE MULTIZONA ECO

## MULTIZONE ECO CONTROL UNIT



FINO A  
**4**  
ZONE CON UN SOLO  
CONTROLLER

UP TO  
**4**  
ZONES WITH ONLY ONE  
CONTROLLER

### SERIE ECO



**CT780** - € 55  
Ricevitore Multizona Eco  
*Multizone Eco Receiver*

- Centrale per il controllo di massimo 4 zone, telecomando RF a scelta tra quegli elencati.
- Controllo di ogni singola zona
- Multifunzione: può comandare strip 12V/24V monocromatiche, dinamiche, RGB
- Uscita: 3AX3CH
- *Control unit for controlling up to 4 zones, RF remote control to be chosen from those listed.*
- *Control of every single zone*
- *Multifunction: it can control 12V / 24V monochromatic, dynamic, RGB strips*
- *Output: 3AX3CH*

Per il funzionamento della serie ECO basta un telecomando a scelta tra il CT770, CT760 o CT750 e un ricevitore CT780 per ogni zona da controllare, fino a un massimo di 4.

*For the operation of the ECO series, a remote control of your choice between the CT770, CT760 or CT750 and a CT780 receiver is sufficient for each zone to be controlled, up to a maximum of 4.*



**CT770** - € 75  
Telecomando RGB  
*RGB remote control*



**CT760** - € 75  
Telecomando Bianco Dinamico  
*Dynamic white remote control*



**CT750** - € 75  
Telecomando Dimmer  
*Dimmer remote control*







# ACCESSORI

## *ACCESSORIES*

## CONTROLLER RGB IN RADIOFREQUENZA

## RGB CONTROLLER IN RADIOFREQUENCY

**CENTRALINA RF RGB BASIC**

Controllo a distanza tramite radio frequenza, trasmette fino a 50 metri in campo aperto

*Radio frequency remote control until 50m in open field*

CODICE	USCITA	LISTINO
CT100	4A X 3CH	41,50 €

**CENTRALINA RF RGB PRO 1**

Controllo a distanza tramite radio frequenza con telecomando touch

*Radio frequency control, with a remote with touch technology*

CODICE	USCITA	LISTINO
CT200	3A X 3CH	85 €

**CENTRALINA RF RGB PRO 2**

Controllo a distanza tramite radio frequenza con telecomando

*Radio frequency remote control until 50m in open field*

CODICE	USCITA	LISTINO
CT300	3A X 3CH	85 €

**CT500**

Centralina con telecomando RF specifico per strip RGB.W consente un controllo totale della nuova tecnologia RGB con il 4° chip da 3000K o 4000K si può ottenere il meglio della RGB senza rinunciare alla luce calda.

*Control unit with specific RF remote control for RGB.W strip allows total control of the new RGB technology with the 4th 3000K or 4000K chip you can get the best of RGB without giving up warm light.*

CODICE	USCITA	LISTINO
CT500	3A X 4CH	127 €

**CT600**

Centralina con telecomando RF specifico per strip RGB.D con circuiti integrati.

Consente il comando delle nostre strip RGB Data con controllo del colore di ogni settore e giochi di luce unici e scenari memorizzabili.

*Control unit with specific RF remote control for RGB.D strip with integrated circuits.*

*It allows the control of our RGB Data strips with color control of each sector and unique light effects and storable scenarios.*

CODICE	USCITA	LISTINO
CT600	MAX 10A	127 €

**CT900**

Centralina con telecomando RF specifico per strip Bianco Dinamico consente un controllo totale della temperatura del colore, passando da 2700 a 6000 K.

*Control unit with specific RF remote control for Dynamic White strip allows total control of the color temperature, going from 2700 to 6000 K.*

CODICE	USCITA	LISTINO
CT900	3A X 3CH	85 €

**CENTRALE DMX**

**DMX CONTROL UNIT**

- Utilizzabile con le STRIP RGB DATA
- Può controllare fino a 105 metri di led
- Compatibile con mixer luci e software DMX

- *Can be used with RGB DATA STRIPES*
- *It can control up to 105 meters of LEDs*
- *Compatible with lighting mixer and DMX software*

Fronte  
Front



**CT600X** - € 500  
Centrale DMX  
DMX control unit

Retro  
Back



Ingresso alimentazione / Power input

Ingresso DMX RJ45 / DMX RJ45 input

Ingresso DMX Cannon / Cannon DMX input



**Telecomando**  
Incluso  
**Remote controller**  
Included



Maggiori informazioni su funzioni e installazione attraverso il nostro ufficio tecnico [tecnico@ledcoitalia.it](mailto:tecnico@ledcoitalia.it)

**FULLY PROGRAMMABLE**  
More about functions and installation through our technical department [tecnico@ledcoitalia.it](mailto:tecnico@ledcoitalia.it)

## DIMMER

**CENTRALINA DIMMER RF BASIC**

Controllo a distanza tramite radio frequenza trasmette fino a 50 metri in campo aperto

*Radio frequency remote control until 50m in open field*

CODICE	USCITA	LISTINO
DM100	MAX 20A	40 €

**CENTRALINA DIMMER RF PRO**

Controllo a distanza tramite radio frequenza trasmette fino a 50 metri in campo aperto. Pulsanti configurabili

*Radio frequency remote control until 50m in open field, with personalized buttons*

CODICE	USCITA	LISTINO
DM200	3A X 3CH	85 €



40 mm

**MINI DIMMER PUSH**

Mini Dimmer per il controllo della luminosità della strip led a 12/24 V, questo dispositivo può essere controllato con un pulsante normalmente aperto.

*Mini Dimmer for controlling the brightness of the 12/24 V led strip, this device can be controlled with a normally open button*

CODICE	USCITA	LISTINO
DM550	MAX 8A	37 €



40 mm

**DIMMER TOUCH**

Mini Dimmer per il controllo della luminosità della strip led a 12/24 V, questo dispositivo può essere controllato tramite sensore capacitivo, per utilizzare il prodotto occorre un profilo di alluminio dove alloggiarlo

*Mini Dimmer for controlling the brightness of the 12/24 V led strip, this device can be controlled by a capacitive sensor, to use the product you need an aluminum profile to house it*

CODICE	USCITA	LISTINO
DM550/T	MAX 5A	32 €

**SENSORE IR**

Sensore ad infrarossi  
*Infrared sensor*

CODICE	LISTINO
SENSORE IR	27 €

**SENSORE ONDE CONVOGLIATE**

Sensore multifunzione per installazioni ad incasso o superficie. Controlla strip monocromatiche.

- Funzione accensione all'apertura dell'anta
- Funzione accensione al passaggio della mano

*Multifunction sensor for recessed or surface installations. Check monochromatic strips.*

- Power on function when the door is opened
- Switch on function when hand passes

CODICE	USCITA	LISTINO
DM551	MAX 3A	45 €



168 mm

**DIMMER DALI**

Dimmer specifico per sistemi DALI, per regolare la luminosità della strip LED monocromatiche a 12/24 V. Questo dispositivo può essere controllato con un pulsante normalmente aperto.

*Specific dimmer for DALI systems, to adjust the brightness of the 12/24 V monochromatic LED strip. This device can be controlled with a normally open button.*

CODICE	USCITA	LISTINO
DM500/D	MAX 10A	120 €

## CONTROLLER PARETE / INCASSO

## WALL / RECESSED CONTROLLER

**DIMMER DA PARETE/INCASSO**

Dimmer da parete per strip led a 12V/24V, con schermo in vetro a sfioramento.

*Wall mounting/recessed dimmer for 12V/24V strip led , with glass touch screen.*

CODICE	USCITA	LISTINO
DM200/P	4A X 2CH	85 €

**CONTROLLER BIANCO DINAMICO**

Controller da parete/incasso per strip dinamiche a 12V/24V, con schermo in vetro a sfioramento.

*Wall mounting/recessed controller for 12V/24V CCT strip led , with glass touch screen.*

CODICE	USCITA	LISTINO
CT900/P	4A X 2CH	85 €

**CONTROLLER RGB**

Controller da parete/incasso per strip RGB a 12V/24V, con schermo in vetro a sfioramento.

*Wall mounting/recessed controller for 12V/24V RGB strip led , with glass touch screen.*

CODICE	USCITA	LISTINO
CT200/P	4A X 3CH	90 €

**CONTROLLER RGB-W**

Controller da parete/incasso per strip RGB.W a 12V/24V, con schermo in vetro a sfioramento.

*Wall mounting/recessed controller for 12V/24V RGB.W strip led , with glass touch screen.*

CODICE	USCITA	LISTINO
CT500/P	3A X 4CH	127 €

**DIMMER 1-10V ROTATIVO**

Dimmer rotativo 1-10V da installazione a parete o incasso. Questo dispositivo va abbinato ad un alimentatore 1-10V per poter funzionare.

*1-10V rotary dimmer for wall or recessed installation. This device must be combined with a 1-10V power supply in order to work.*

CODICE	LISTINO
DM200/P110	160 €

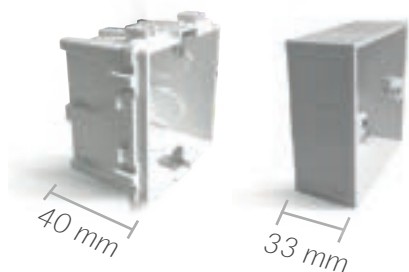
**CASSETTE 86X86 mm**

*Mounting box controller 86x86mm*

CODICE	TIPOLOGIA	LISTINO
PT86I	INCASSO	9 €
PT86	SOVRAPPOSTA	9 €



### CT800

Gateway Multizona Pro, consente di collegare in radiofrequenza i pannelli touch consentendo un controllo da smartphone tramite app dedicata

- Controllo di ogni singola zona
- Controllo locale o remoto
- 2 in 1 control: Wireless RF e connessione wired
- Controllo vocale, supporto di Amazon ECHO

*Multizone gateway Pro, allows you to connect the touch panels by radio frequency and ensuring the control by the smartphone via dedicated app*

- *Control of every single zone*
- *Local or remote control*
- *2 in 1 control: Wireless RF and wired connection*
- *Voice control, support amazon ECHO*

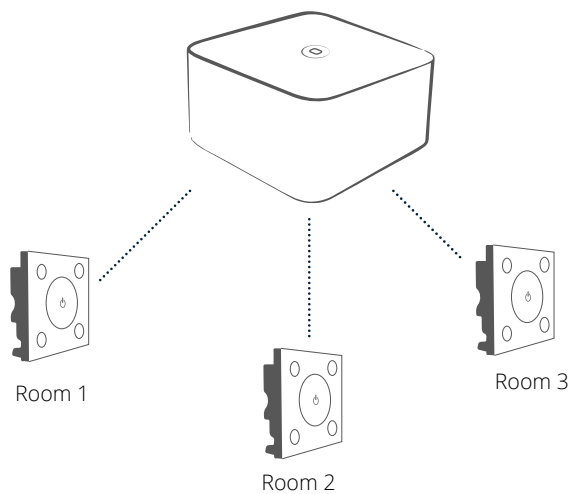

**CT800** - € 800  
Gateway Multizona Pro  
Multizone Receiver Pro

SCARICA L'APP  
DOWNLOAD APP



## AMPLIFICATORI

## AMPLIFYING

**AMPLIFICATORE DIMMER**

Ogni amplificatore può comandare due strip da 5 MT, compatibile con tutti i Dimmer a catalogo.

*Each amplifier can control two 5 meters strip led, compatible with all dimmers in the catalog.*

CODICE	USCITA	LISTINO
DM300	MAX 20A	37 €



177 mm

**AMPLIFICATORE SEGNALE BIANCO DINAMICO**

Amplificatore per centraline bianco dinamico, 12/24v. Compatibile con tutte le centraline bianco dinamico (cct) a catalogo.

*Amplifier for dynamic white control units, 12 / 24v. Compatible with all dynamic white (cct) control units in the catalog.*

CODICE	USCITA	LISTINO
CT910	8A X 2CH	70 €

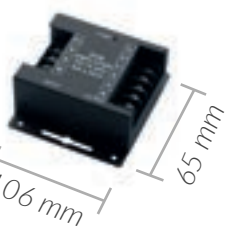

106 mm

65 mm

**AMPLIFICATORE SEGNALE RGB**

Ogni amplificatore può comandare due strip RGB da 5 MT

*Each amplifier can control two 5 meters strip led*

CODICE	USCITA	LISTINO
CT400	6A X 3CH	42,50 €

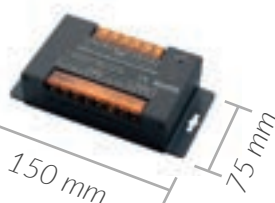

150 mm

75 mm

**AMPLIFICATORE SEGNALE RGB-W**

Amplificatore per centraline rgbw, 4 Canali, 12/24v. Compatibile con tutte le centraline rgbw a catalogo

*Amplifier for rgbw control units, 4 channels, 12 / 24v. Compatible with all rgbw control units in the catalog*

CODICE	USCITA	LISTINO
CT410	8A X 4CH	55 €

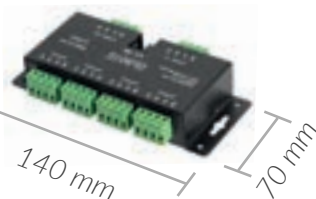

140 mm

70 mm

**AMPLIFICATORE SEGNALE RGB-D**

Amplificatore per centraline rgb dati 12/24V.

*Amplifier for 12 / 24V rgb data controllers.*

CODICE	USCITA	LISTINO
CT420	MAX 12A	55 €



## KIT IN EMERGENZA

## EMERGENCY KIT



CODICE	DURATA*	LISTINO
EM1500	1,5 Ore	100 €
EM3000	3 Ore	130 €

\*esempio con strip SL60

\*\*la durata dipende dalla potenza della strip, fare riferimento alle schede tecniche per maggiori dettagli.

**Kit in emergenza**

Kit inverter e pacco batteria per strip LED 12V / 24V / 48V, con dip switch per selezione corrente in emergenza, batterie integrate e doppio isolamento.

**Emergency Kit**

LED emergency converter with battery pack included, it can be used for 12V/24V strip led.

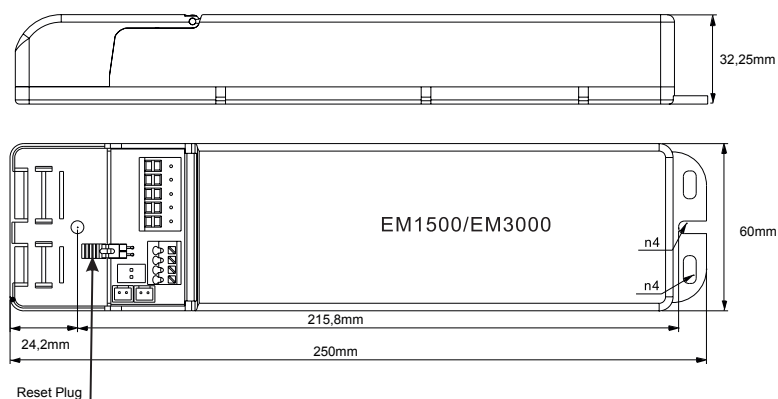

Reset Plug: la spina di reset deve essere sempre inserita durante il funzionamento. Rimuovere la spina in modalità di emergenza, quindi inserire di nuovo la spina, il sistema può essere ripristinato.

Reset Plug: the reset plug need to be always inserted during operation. Remove the plug on emergency mode, then insert the plug again, the system can be reset.

## CONNETTORI RAPIDI

## QUICK CONNECTORS



Connettore singolo strip RGB 10 mm  
con cavo di connessione  
*Single 10 mm RGB strip connector  
with connection cable*

CODICE	LISTINO
CAB810	€ 2



Connettore doppio per strip SL60/  
SL120/SL180 da 10mm IP20  
*Double connector for SL60/SL120/  
SL180 strip IP20*

CODICE	LISTINO
CNT1010	€ 2



Connettore rapido  
per strip SL60/SL120/SL180  
da 10 mm IP20  
*Quick connector for SL60/SL120/SL180  
10 mm IP20 strips*

CODICE	LISTINO
CNT10	€ 2



Connettore per strip RGBW 10mm  
*Strip RGBW 10mm connector*

CODICE	LISTINO
CNT10-5P	€ 2



Connettore doppio per strip  
RGBW 10mm C/Cavo 15 cm  
*Double connector for 10mm  
RGBW strip with 15cm cable*

CODICE	LISTINO
CNT1010-5P	€ 2



Connettore per strip SL200/SL200ES  
*Strip SL200/SL200ES connector*

CODICE	LISTINO
CNT200	€ 2



Connettore per strip SL200/SL200ES  
con cavo da 15cm  
*Connector for SL200/SL200ES strips  
with 15cm cable*

CODICE	LISTINO
CNT200-15	€ 3,50



Connettore singolo per strip IP20 SL60/  
SL120/SL180 da 10 mm  
con cavo di connessione  
*Single connector for 10 mm IP20 SL60/  
SL120/SL180 strip with connection cable*

CODICE	LISTINO
CNT1015	€ 2



Connettore singolo per strip IP65 SL60/  
SL120/SL180 da 10 mm  
con cavo di connessione  
*Single connector for 10 mm IP65 SL60/  
SL120/SL180 strip with connection cable*

CODICE	LISTINO
CNT1015W	€ 2



Connettore rapido per strip SL60/SL120/  
SL180 da 10 mm IP65  
*Quick connector for SL60/SL120/SL180  
10 mm IP65 strips*

CODICE	LISTINO
CNT10W	€ 2



Connettore singolo strip RGBW  
10mm C/Cavo 15 mm  
*Single RGBW 10mm strip connec-  
tor with 15mm cable*

CODICE	LISTINO
CNT1015-5P	€ 2



Connettore rapido per strip RGB  
10mm IP65  
*Quick connector for 10mm IP65  
RGB strips*

CODICE	LISTINO
CNT10-4P	€ 2

## NASTRO ADESIVO ELETTRIFICATO

### ELECTRICAL ADHESIVE TAPE



15mm



CODICE	LISTINO
--------	---------

NE205	11 € / mt
-------	-----------

Nastro elettrico adesivo verniciabile.  
 Due piste da 0,5mm<sup>2</sup>  
 Larghezza 15mm  
 Spessore 0,25mm

*Electrical adhesive tape, paintable.  
 Two 0,5mm<sup>2</sup> tracks  
 Width 15mm  
 Thickness 0,25mm*

Grazie al Next Tape sarà possibile portare un punto elettrico in qualsiasi zona di nostro interesse senza dover realizzare delle tracce nei muri e rompere le pareti creando polvere e disordine.

Regge carichi fino a 48V. Non adatta per 220V.

*Thanks to Next Tape it will be possible to get an electrical point to any area of our interest without having to create traces in the walls and break the walls creating dust and disorder.*

*Load voltage up to 48V. Not suitable for 220V.*

Scopri maggiori informazioni  
 Discover more informations







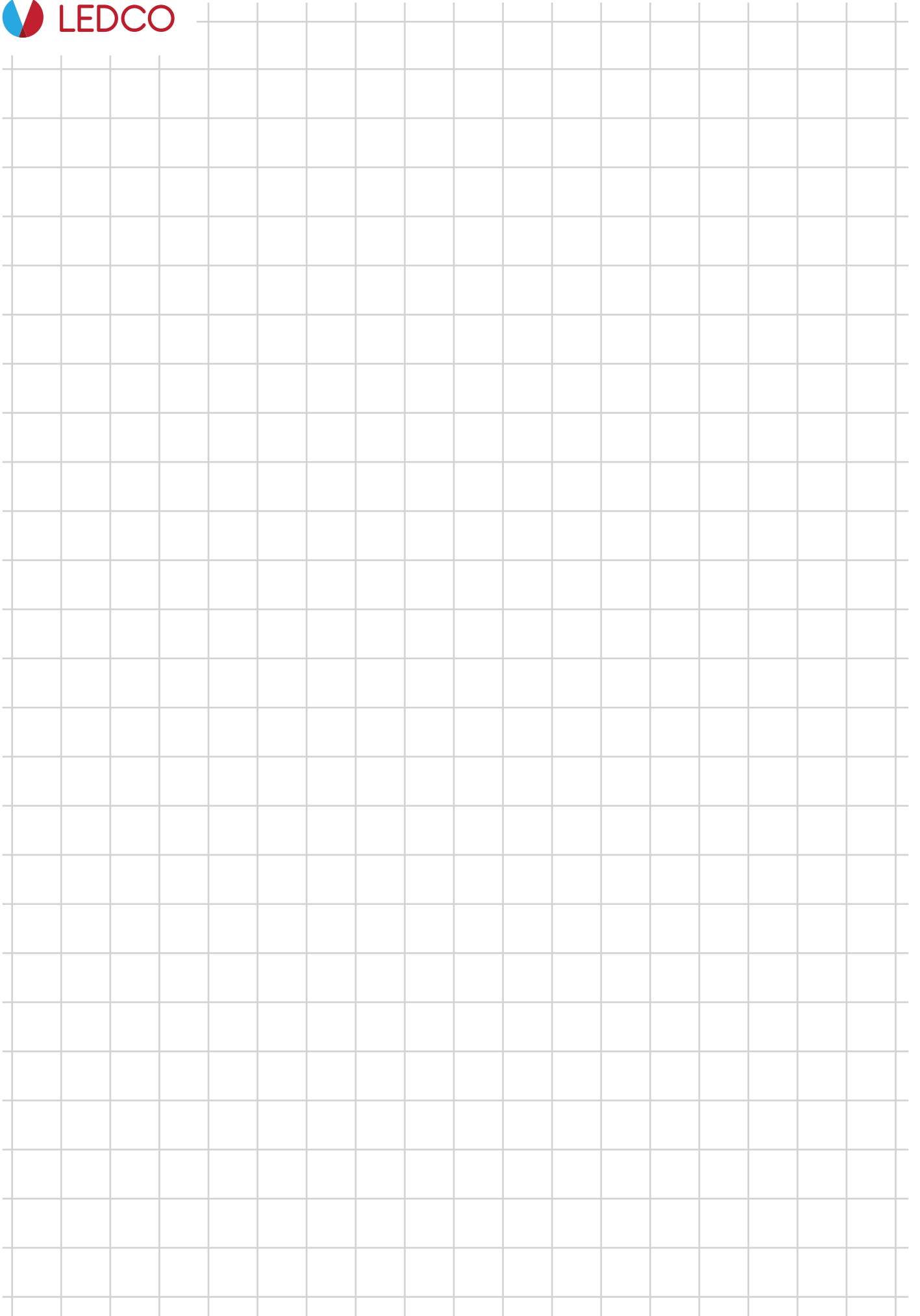



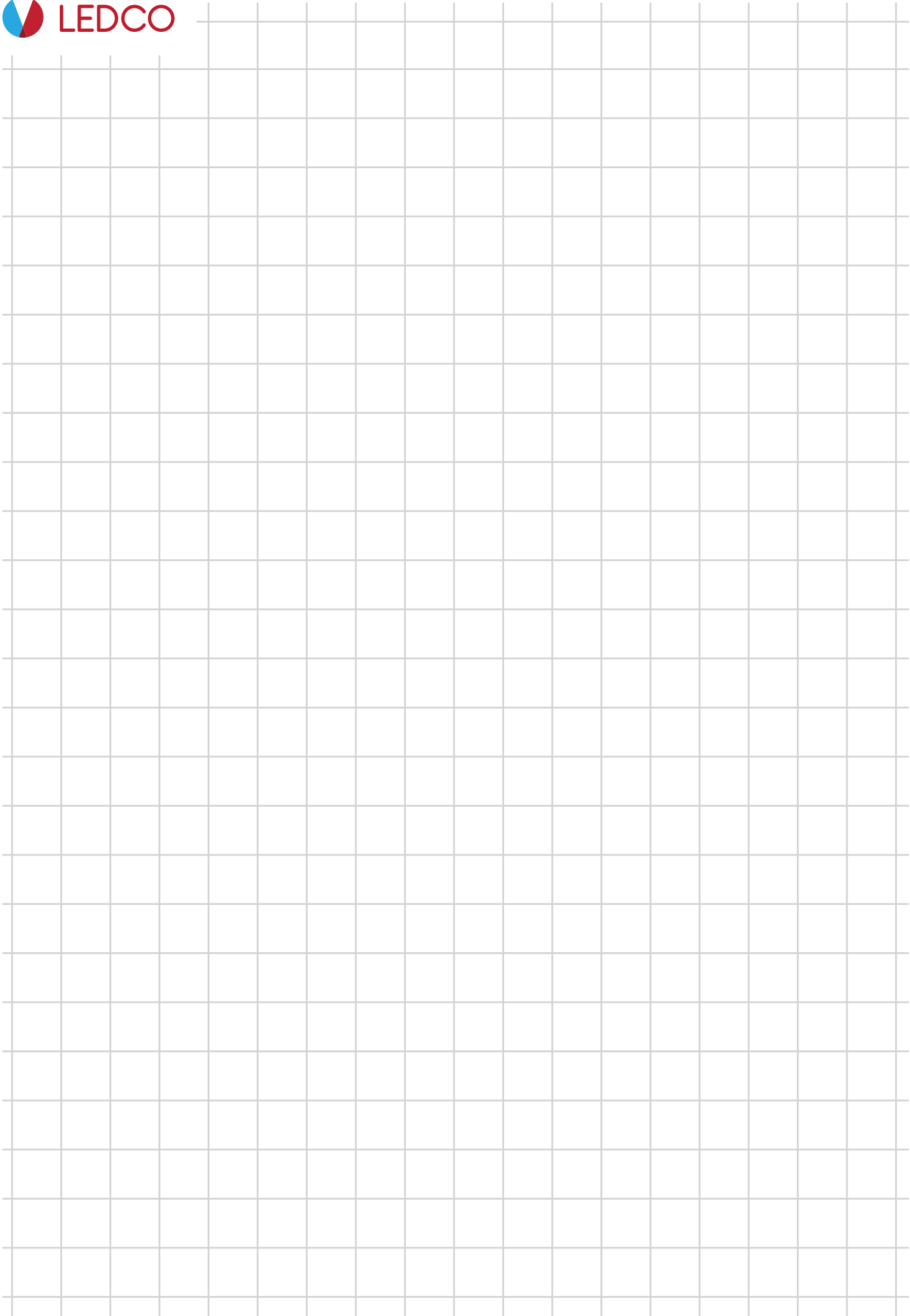



## Art. 1. Prodotti

- 1.1 La LEDCO si riserva la facoltà di apportare, in qualunque momento e senza preavviso, modifiche nella costruzione degli apparecchi luminosi e degli accessori.

## Art. 2. Dichiarazioni dell'acquirente

- 2.1 Ai fini di quanto previsto dall'art. 25 della Legge 06/02/1996 n° 52 di recepimento della direttiva CE n° 93/1993, relativa alle clausole vessatorie, l'acquirente dichiara che provvederà all'acquisto dei prodotti della LEDCO agendo esclusivamente per fini che rientrano nella sua specifica attività professionale imprenditoriale e quindi dichiara di essere a conoscenza dei prodotti, servizi e prezzi offerti al momento della consegna.

## Art. 3. Consegna

- 3.1 Il termine di consegna fissato convenzionalmente è soltanto indicativo e decorre, dall'invio da parte della LEDCO, della conferma d'ordine a condizione che l'acquirente abbia fornito tutti i dati tecnici e tutti i documenti necessari, abbia adempiuto a tutte le obbligazioni contrattuali ed abbia versato l'acconto eventualmente richiesto. La consegna, così come previsto dall'art. 13.1, si intende effettuata alla data di partenza franco spedizioniere.

## Art. 4. Contestazioni

- 4.1 Il Foro di Bari è esclusivamente competente a decidere qualunque controversia dovesse insorgere tra le parti e in particolare quelle relative alle trattative contrattuali, alla conclusione, esecuzione, interpretazione, o risoluzione di tutti i contratti intervenuti ed alla relativa garanzia.

## Art. 5. Esecuzioni speciali

- 5.1 È possibile ottenere esecuzioni speciali in alcune serie di prodotti. Il prezzo, le quantità minime dei prodotti e i tempi di consegna verranno concordati su richiesta.

## Art. 6. Garanzia

- 6.1 Ogni apparecchio viene garantito integralmente per la durata di 24 mesi con decorrenza dalla data di consegna per tutti i possibili difetti di fabbricazione, di materiale e per tutti i guasti non imputabili al cliente.
- 6.2 Sono esclusi dalla garanzia tutti i guasti dovuti a cause di forza maggiore (fulmine, incendio, etc.) nonché tutti i danni causati da un uso improprio dell'apparecchiatura. Sono altresì escluse dalla garanzia le batterie e gli accumulatori.
- 6.3 LA GARANZIA DECADE INDEROGABILMENTE IN CASO DI MANOMISSIONI DEGLI APPARECCHI DA PARTE DI PERSONE O TECNICI NON ESPRESSAMENTE AUTORIZZATI DALLA LEDCO.

## Art. 7. Offerte

- 7.1 Gli agenti o preposti della LEDCO non hanno il potere di vincolare quest'ultima, salvo conferma espressa per iscritto.

## Art. 8. Ordini

- 8.1 Gli ordini dell'acquirente devono essere effettuati per iscritto e, se trattasi di persona giuridica, devono essere sottoscritti da persona all'uopo autorizzata ad impegnare la stessa. In ogni caso l'esistenza del potere di rappresentanza del sottoscrittore si presume a favore della LEDCO.
- 8.2 Ogni eventuale ordine telefonico dovrà essere confermato per iscritto. In difetto l'ordine si ritiene non pervenuto.
- 8.3 La LEDCO si riserva, in ogni caso, il diritto di richiedere, al momento dell'ordine da parte dell'acquirente, un acconto oppure il pagamento integrale della fornitura.

## Art. 9. Pagamento

- 9.1 Il pagamento deve essere effettuato entro il termine convenuto nel modo e col mezzo indicato nell'ordine e al domicilio del venditore (LEDCO) e ciò anche nei casi di ritardo nell'arrivo della merce, o di avarie o perdite totali o parziali verificatesi durante il trasporto, nonché nel caso in cui le merci messe a disposizione dell'acquirente mediante consegna allo spedizioniere, non vengano dall'acquirente stesso ritirate.
- 9.2 La eventuale accettazione, da parte della venditrice, di tratte o di altri effetti di commercio si intenderà avvenuta con la clausola "salvo buon fine".
- 9.3 Sui pagamenti differiti anche cambiari, dalla LEDCO preventivamente accettati, è in ogni caso dovuto l'interesse decorrente dalla data della fattura, secondo il tasso praticato dalle banche sugli scoperti di conto corrente vigente alla data di pagamento.
- 9.4 Eventuali sconti di cassa, nonché abbuoni o premi di qualsiasi natura saranno accordati a condizione che il cliente non abbia pagamenti in sospeso e si intenderanno automaticamente decaduti e revocati in caso di mancato pagamento.
- 9.5 In caso di ritardato pagamento alle scadenze prestabilite, verranno riconosciuti alla Società venditrice LEDCO gli interessi bancari correnti PRIME RATE aumentati di 3 punti. L'inadempienza nei pagamenti relativi a più rate, od anche ad una sola che superi l'ottava parte del prezzo, farà decadere il compratore dal beneficio del termine rateale e darà diritto alla venditrice di richiedere subito il residuo saldo del prezzo, oppure di ritenere senz'altro risolto il contratto con restituzione immediata della merce ed acquisizione, a titolo di indennizzo, delle rate pagate, salvo, comunque, il risarcimento dei danni.

#### **Art. 10. Riserva di proprietà**

- 10.1 Le apparecchiature indicate in ordine ed i relativi accessori sono venduti con RISERVA DI PROPRIETA' a favore della venditrice LEDCO e, quindi, il compratore ne acquisterà la proprietà soltanto al pagamento dell'ultima rata di prezzo, ma ne assume i rischi al momento della consegna (art. 1523 C.C.).
- 10.2 Qualora per opera di terzi venisse operato un sequestro o un pignoramento, l'acquirente si impegna a far inserire, nel relativo verbale di esecuzione redatto dal precedente, la dichiarazione che proprietà in virtù di riservato dominio è la LEDCO, e ad informare immediatamente la stessa perchè possa agire in sede di opposizione di terzo a rituale rivendita, con diritto di rivalsa per tutte le spese relative.

#### **Art. 11. Prezzi ed oneri fiscali**

- 11.1 Sugli ordini verranno applicati i prezzi al pubblico riportati nel "listino prezzi", eventuali condizioni particolari dovranno essere pattuite ed autorizzate dalla LEDCO in maniera scritta.
- 11.2 I prezzi applicati sono suscettibili di essere modificati sino alla conferma dell'ordine da parte della LEDCO. La modifica avviene in relazione alla variazione del rapporto di cambio, dei costi delle materie prime nonché di eventuali tasse o imposte applicabili al contratto.
- 11.3 Il prezzo definitivo, al netto delle tasse e/o imposte è quello riportato sulla conferma d'ordine della LEDCO e si intende per merce resa franco spedizioniere.
- 11.4 Valgono inoltre le seguenti condizioni:  
- consegne franco fabbrica per ordini al valore netto inferiore a € 500 per l'Italia;  
- consegne franco destino per l'Italia per ordini di valore netto superiori a € 500 per l'Italia;  
- consegne EX-Works per l'estero.
- 11.5 Valore minimo fatturabile: € 200 .

#### **Art. 12. Reclami**

- 12.1 Eventuali reclami per vizi o difetti della merce ci vanno comunicati con lettera raccomandata entro e non oltre 8 giorni dalla scoperta del difetto, sotto pena di decadenza di ogni azione di garanzia.

#### **Art. 13. Trasporti**

- 13.1 La merce viaggia sempre a rischio e pericolo dell'acquirente.
- 13.2 Qualora la LEDCO provveda a stipulare il contratto di trasporto con il vettore, agirà sempre per conto e con spese a carico dell'acquirente, con le conseguenze di cui all'art. 13.1. In tal caso, il prezzo dei prodotti sarà comprensivo dei costi del trasporto.
- 13.3 La LEDCO non è tenuta a concludere alcun contratto di assicurazione contro i rischi di trasporto.
- 13.4 In caso di avarie, rotture, furti o manomissioni della merce durante il trasporto o nel caso di ritardi di consegna imputabili allo spedizioniere e/o al vettore, l'acquirente potrà rivalersi nei confronti dello spedizioniere e/o del vettore incaricato, essendo esclusa qualsivoglia responsabilità della LEDCO al riguardo.
- 13.5 Il cliente deve accertare peso e condizioni della merce all'atto della consegna.
- 13.6 La LEDCO si riserva la scelta del mezzo di trasporto, salvo pattuizione scritta contraria.

#### **Art. 14. Conclusioni**

- 14.1 Le presenti condizioni generali di vendita sono le sole applicabili nei rapporti tra la LEDCO e l'acquirente; in particolare è esclusa l'applicazione delle condizioni generali o particolari di contratto dell'acquirente, a meno che la LEDCO non le abbia accettate per iscritto.
- 14.2 Le parti espressamente dichiarano di escludere la applicazione della Convenzione di Vienna del 11/04/1980 (ratificata dallo Stato italiano con L. 11/12/1985 n° 765) in conformità a quanto previsto dall'art. 6 della stessa.
- 14.3 Per tutto quanto non previsto dalle presenti condizioni si applicano, ai singoli contratti, le norme sui contratti in generale (art. 1321 e ss.) e sul contratto di compravendita in particolare (art. 1470 e ss.) contemplate dal codice civile italiano.

**Non ci assumiamo responsabilità per errori di stampa.**

**La società si riserva il diritto di apportare modifiche sui prodotti qui illustrati, in qualsiasi momento, senza preavviso. Sono vietate riproduzioni o copie senza autorizzazione.**

**We are not responsible for printing errors, wrong dimensions.**

**The company reserves the right to amend all products herein detailed, any time and without prior notice.**

**Unauthorized reproductions and copies are prohibited.**

Per le condizioni commerciali estere contattare il numero 0039 0805046806 o visitare il sito [www.ledcoitalia.it](http://www.ledcoitalia.it)

*For the export general sale condition please visit the website [www.ledcoitalia.it](http://www.ledcoitalia.it)*





**Sede / Headquarters**

Via Nicola Ruffo, 27 - 70124 Bari - Italy

Tel. +39 080 504 6806

[www.ledcoitalia.it](http://www.ledcoitalia.it) | [info@ledcoitalia.it](mailto:info@ledcoitalia.it)