



Decorative





index



AFRODITE.320
AGNESE.428
ALICE KIT.128
ALICE.122
APRILIA.36
BABOL.296
BARBIE.258
BILBAO.356
BILDE.352
BLANCA.254
BONELLA.250
CAMILLA.442
CHRISTINE.312
CINZIA.262
CLEOFE.138
CRISEIDE.186
DAFNE.62
DHARMA.314
DIVA.210
DOHA.302
EMILY.238
ENILA.284
ERIKA.176
FILLY.148
FIRENZE.12
FLASH FLIP FLUTE KIT.158
FLASH FLIP FLUTE.154
FLOR.268
FORTUNA.288
FRIDA.436
GAETA S.26
GAETA.18
GAP ARCO.376
GAP LINEA.378
GENOVA.38
GISELLE.360
GORIZIA.34
GUYA.54
HELENA.70
IOLE.196
ISOTTA.364
JESI.42
JULIETTE.244
KRIZIA.222
LARA.448
LECCE.454
LIVORNO S.43
LORETO S.44
LUNA.370
MAGIS.388
MELANIA.316
MICHELA.418
MODENA.40
NARDÒ S.45
NARDÒ.39
NEKKAR.400
NEREIDE.422
NICOLE.404
NUMA.108
NUNKI.402
OFELIA.74
ONE.394
PING-PONG.412
PIXEL.348
PLUG.292
POINT.336
POLAR.380
RAIKA.94
RAKE.274
RING.384
SFERA.170
SHEILA.282
STEP.338
TESSA.328
TOSCA.332
TULLIA.324
YARA.232
YOANA.300
YPSILON.408



COSTRUIRE IL FUTURO BUILDING THE FUTURE

Più che una mission è una vocazione quella di Lucia, Enrico e Antonio, i tre fratelli a capo di GEA LUCE, fondata 30 anni fa, che portano avanti il pensiero originario di unire estetica e funzionalità all'avanguardia nei prodotti d'illuminazione. Cambiano gli stili, subentrano nuovi materiali e applicazioni, ma la filosofia di base è sempre la stessa: creare soluzioni d'illuminazione che siano efficienti, a basso consumo, facili da installare e belle da guardare. GEA LUCE è prospettiva, è visione, è futuro, per dare sempre a tutti la luce giusta.

More than just a mission, it is a calling that Lucia, Enrico and Antonio, the three siblings at the head of GEA LUCE, founded 30 years ago, carrying on the original idea of combining aesthetics and functionality at the forefront of lighting products. Styles change, with new materials and applications, but the underlying philosophy is always the same: to create lighting solutions that are effective, energy-efficient, easy to install and aesthetically pleasing. GEA LUCE is perspective, it is vision, it is the future, always providing everyone with the right light.





LA TUA LUCE

YOUR LIGHT

GEA LUCE è un'azienda orientata al futuro, capace di offrire soluzioni d'illuminazione all'avanguardia, dove design, stile e tecnologia sono un tutt'uno. Un'offerta molto ampia per dare risposte tecniche, non solo estetiche, al tema del benessere abitativo. Perché sappiamo che, oggi più che mai, la giusta illuminazione negli ambienti, sempre più polifunzionali e dinamici, è un punto cruciale della progettazione degli spazi. Con GEA LUCE le persone scelgono ciò che piace ed emoziona, con la garanzia di avere un prodotto dalle grandi prestazioni illuminotecniche, ottimizzate e progettate per durare, grazie all'uso della tecnologia LED.

GEA LUCE is a future-oriented company that offers cutting-edge lighting solutions combining design, style and technology. Our wide range provides technical and aesthetic solutions for visual comfort in the home. Because we know that today more than ever, having the right lighting in our increasingly multipurpose and dynamic environments is crucial when it comes to interior design. With GEA LUCE, people can choose what they like and what excites them, with the added guarantee of a product that has great lighting performance, optimal design and is made to last, thanks to LED technology.



Tutti i luoghi dove si vive bene hanno in comune una cosa: l'armonia. E quando si arreda un'ambiente, progettare la giusta illuminazione è un elemento chiave per raggiungere un risultato armonioso. Con GEA LUCE progettare è facile, perché c'è una risposta ad ogni tipo di situazione: luce diretta o indiretta, d'accento o d'ambiente, diffusa o d'atmosfera, sono tantissimi i prodotti a disposizione. La luce si fa così personale e personalizzabile, con tante soluzioni componibili e modulari, dal design sempre accattivante. Ma con GEA LUCE progettare è facile anche grazie al suo ufficio tecnico, un team di specialisti, giovane e dinamico, sempre pronto ad aiutare il cliente nel trovare la soluzione ideale alle sue necessità illuminotecniche.

All feel-good homes have one thing in common: harmony. When you are furnishing a space, designing the right lighting is key to achieving a harmonious result. With GEA LUCE, designing is easy. We have an answer for any setting: direct or indirect, accent or ambient, diffused or atmospheric lighting, there are many products available. Lighting becomes personal and customisable thanks to our many modular, adaptable solutions: all with a captivating design. Designing with GEA LUCE is also easy for another reason: our technical office. Our team of dynamic young specialists is always ready to help customers find the ideal solution to their lighting needs.

**IL TUO
PROGETTO**
YOUR PROJECT

LAMPADE A SOSPENSIONE

SUSPENSION LAMPS



AGNESE 428



ALICE 122



BARBIE 258



BLANCA 254



BONELLA 250



CAMILLA 442



CINZIA 262



CLEOFE 138



NEW

CRISEIDE 186



DAFNE 62



DIVA 210



EMILY 238



NEW

ERIKA 176



FILLY 148



FLASH 154



FLIP 154



FLUTE 154



GISELLE 360



GUYA 54



HELENA 70



IOLE 196



ISOTTA 364



NEW

JULIETTE 244



KRIZIA 222



LUNA 370



NEREIDE 422

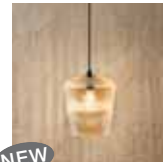

NEW

NUMA 108



NEW

OFELIA 74



NEW

RAIKA 94



SFERA 170



YARA 232

LAMPADE A SOFFITTO

CEILING LAMPS



AFRODITE 320



AGNESE 428



BILBAO 356



BILDE 352



CAMILLA 442

NEW
CHRISTINE 312NEW
DHARMA 314

DIVA 210



DOHA 302



EMILY 238

NEW
FLOR 268

FRIDA 436



GISELLE 360



ISOTTA 364



KRIZIA 222



LARA 448



LECCE 454



LUNA 370



MELANIA 316



MICHELA 418



NEREIDE 422



PIXEL 348



POINT 336



RAKE 274

NEW
SHEILA 282

STEP 338



TESSA 328



TOSCA 332



TULLIA 324



YARA 232

LAMPADE A PARETE

WALL LAMPS

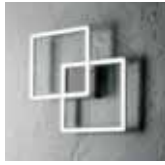

AFRODITE 320



AGNESE 428



BABOL 296



CAMILLA 442



NEW

DIVA 210



DOHA 302



NEW

ENILA 284



NEW

FORTUNA 288



FRIDA 436



NEW

GAP ARCO 376



NEW

GAP LINEA 378



LARA 448



LECCE 454



MAGIS 388



MICHELA 418



NEREIDE 422



ONE 394



PLUG 292



POINT 336



POLAR 380

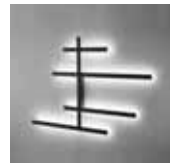

RAKE 274



RING 384



STEP 338

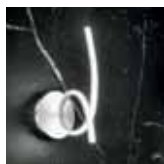

TOSCA 332



TULLIA 324



NEW

YOANA 300

LAMPADE DA TERRA

FLOOR LAMPS



IOLE 196



PING-PONG 412



YPSILON 408

LAMPADE DA TAVOLO

TABLE LAMPS



AGNESE 428



CAMILLA 442



DIVA 210



IOLE 196



NICOLE 404



NEKKAR 400



NEREIDE 422



NUNKI 402

SISTEMI A BINARIO

TRACK SYSTEMS



NEW
APRILIA 36

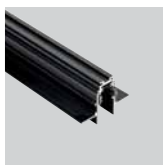

FIRENZE 12



GAETA 18



NEW
GAETA S 26

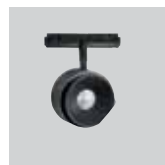

GENOVA 38



NEW
GORIZIA 35

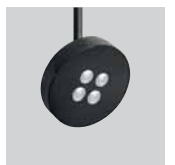

JESI 42



LIVORNO S 43



LORETO S 44



MODENA 40

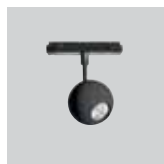

NARDÒ 39



NARDÒ S 45

A black track lighting system is shown against a dark background. The track is a thick black line that forms a large triangle. A gold cylindrical light fixture is mounted on the top arm of the triangle. Two black cylindrical light fixtures are mounted on the bottom arm of the triangle. The gold fixture is illuminated, casting a warm glow. The black fixtures are also illuminated, casting a cooler glow.

I SISTEMI A BASSISSIMA TENSIONE FIRENZE E GAETA, REALIZZATI CON PROFILI MAGNETICI PERMETTONO UN FACILE ALLOGGIAMENTO DI APPARECCHI DI ILLUMINAZIONE LINEARI, PROIETTORI E LUCI A SOSPENSIONE INSTALLABILI IN QUALSIASI PUNTO DEL BINARIO.

THE ULTRA LOW VOLTAGE FIRENZE AND GAETA SYSTEMS, BUILT WITH MAGNETIC PROFILES, CAN EASILY FIT LINEAR LIGHTING FIXTURES, FLOODLIGHTS, AND PENDANT LIGHTS, WHICH CAN BE INSTALLED ANYWHERE ON THE TRACK.



FILA CONTINUA

FIRENZE



Il binario da incasso permette un'integrazione totale con l'architettura dell'ambiente indoor grazie al suo design moderno, minimalista, sobrio. Il binario da incasso si può installare a controparete o controsoffitto in cartongesso con spessore da 12,5 mm.

Con il binario magnetico da incasso si possono realizzare una infinità di soluzioni per l'illuminazione degli spazi interni con la raffinatezza e la discrezione di un sistema dall'effetto architettonico sorprendente.

Recessed tracks allow total integration with the architecture of the indoor environment thanks to their modern, minimalist, sober design. Recessed tracks can be installed on a false wall or false plasterboard ceiling with a thickness of 12.5 mm. Using recessed magnetic tracks, you can create endless solutions for lighting interior spaces, with the refinement and discretion of a system that offers a surprising architectural effect.

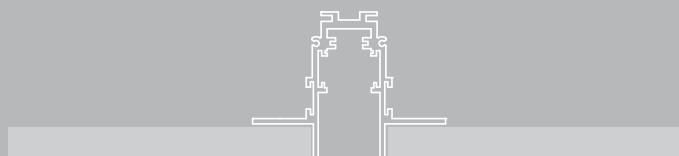

Sistema binario magnetico 48Vdc da incasso.
48Vdc recessed magnetic track system.







FIRENZE

Facile, versatile, fantasioso
Easy, versatile, fantasious



CORPI ILLUMINANTI LIGHTING FIXTURES

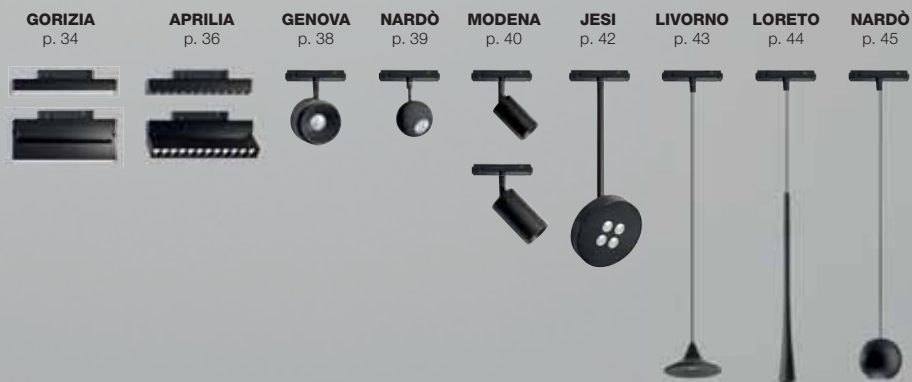

Disegna sentieri luminosi, utilizzando specifici accessori grazie ai quali potrai raggiungere angoli o posizioni a te gradite collegando in un'unica linea continua le pareti con il soffitto, permettendo di posizionare a piacere i punti luce.

Con il sistema binario magnetico da incasso avrai sempre la possibilità di modificare nel tempo la posizione delle sorgenti e creare sempre nuovi scenari luminosi.

Design light paths using specific accessories to reach the desired corners or positions, connecting walls with the ceiling in a single continuous line to produce your preferred lighting arrangement.

The recessed magnetic track system allows changing the lighting configuration anytime to produce entirely new lighting scenarios at will.



GAETA

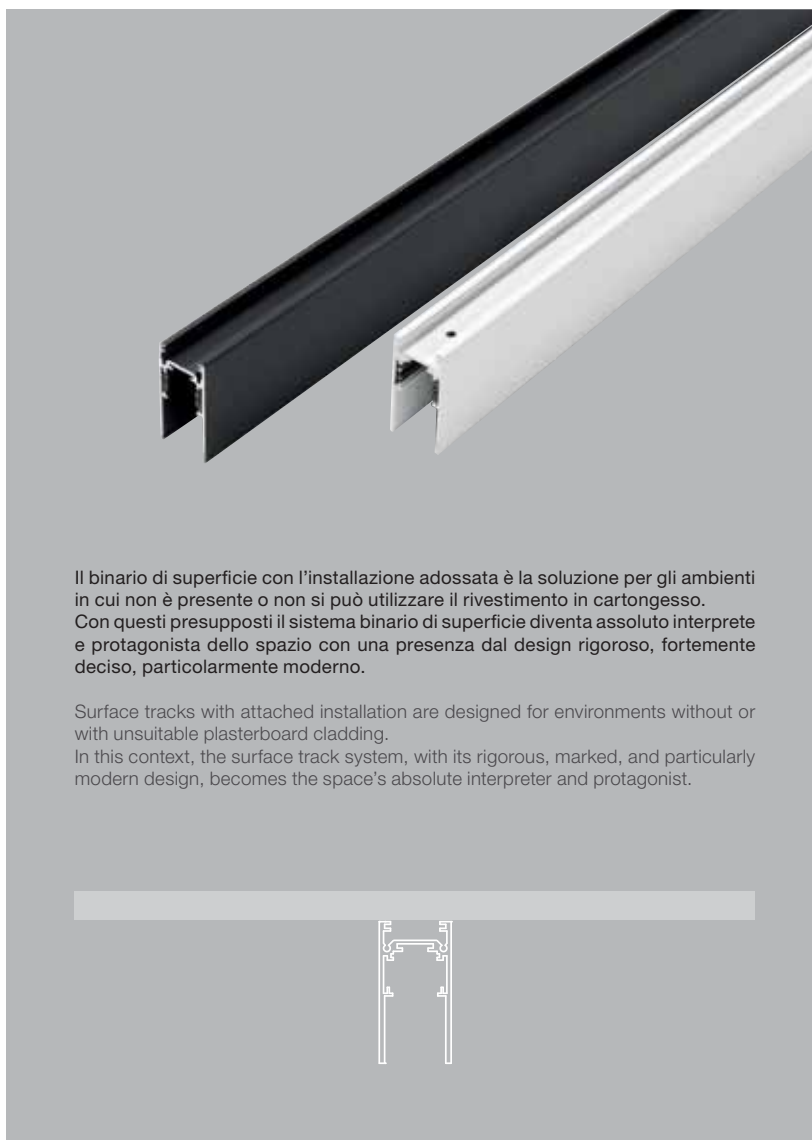

Il binario di superficie con l'installazione adossata è la soluzione per gli ambienti in cui non è presente o non si può utilizzare il rivestimento in cartongesso. Con questi presupposti il sistema binario di superficie diventa assoluto interprete e protagonista dello spazio con una presenza dal design rigoroso, fortemente deciso, particolarmente moderno.

Surface tracks with attached installation are designed for environments without or with unsuitable plasterboard cladding.

In this context, the surface track system, with its rigorous, marked, and particularly modern design, becomes the space's absolute interpreter and protagonist.

Sistema binario magnetico 48Vdc di superficie.
48Vdc surface magnetic track system.





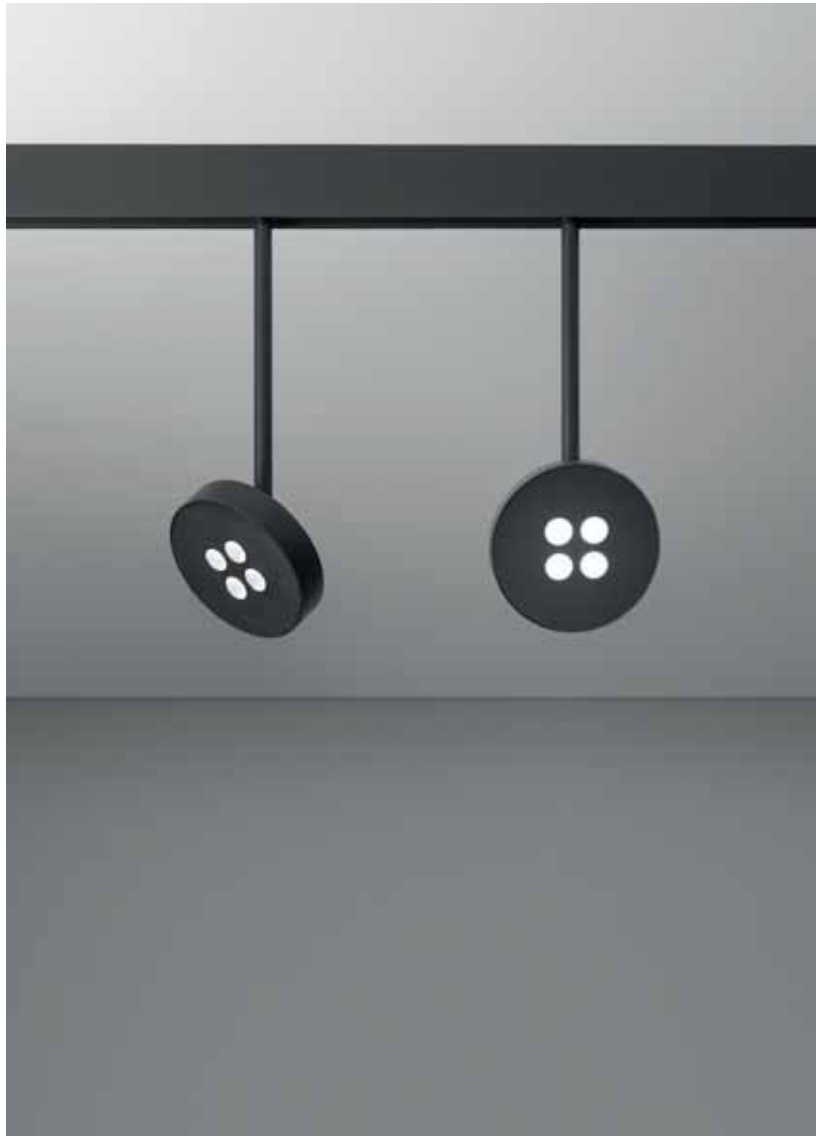

GAETA

Smart, agevole, semplice
Smart, easy, simple



CORPI ILLUMINANTI LIGHTING FIXTURES



Spazio alla creatività, progetta e configura un percorso di luci alternativo, speciale, personalizzato dove inserire luci dal design pulito, minimalista, essenziale con forme e colori diversi, che ben si prestano a coesistere in maniera armonica e funzionale, rendendo l'architettura dei tuoi interni unica e ricercata.

As a tool for creativity, the system serves to design and configure an alternative, special, and personalised lighting path, where you can insert lights with a clean, minimalist, essential design featuring diverse shapes and colours. A visual variety that blends in naturally, in a harmonious and functional way, making your interior spaces unique and sophisticated.







BINARIO IN SOSPENSIONE



GAETA S



Sistema binario magnetico 48Vdc di superficie.
48Vdc surface magnetic track system.







IDEALE ANCHE PER AMBIENTI DALLE METRATURE GENEROSE E SOFFITTATURE CON ALTEZZE IMPORTANTI, GRAZIE ALLA VERSATILITÀ DEGLI ACCESSORI IN DOTAZIONE E ALLE TIGES DI SOSPENSIONE DEL BINARIO GAETA SI POSSONO STRUTTURARE DEI GRIGLIATI PER UNA MAGGIOR E MIGLIORE DISTRIBUZIONE DELLA LUCE SCEGLIENDO I CORPI ILLUMINANTI TRA LA VASTA GAMMA DI PRODOTTI DISPONIBILI.

ALSO IDEAL FOR LARGE SPACES AND HIGH CEILINGS. WITH THE VERSATILE ACCESSORIES AND SUSPENSION TIGES ON THE GAETA TRACK, GRATINGS CAN BE STRUCTURED TO ENHANCE LIGHT DISTRIBUTION, BY CHOOSING LUMINAIRES FROM THE WIDE RANGE AVAILABLE.



TIGES PER SOSPENSIONI TIGES FOR SUSPENSIONS



Le nuove tiges disponibili in due altezze 750mm o 450mm, nelle versioni con rosone o senza. Si inseriscono e scorrono nell'apposita cava del binario diventando un corpo unico.

The new tiges are available in two heights, 750 mm or 450 mm, with or without ceiling canopy. They simply slide into the appropriate slot on the track, becoming a single unit.

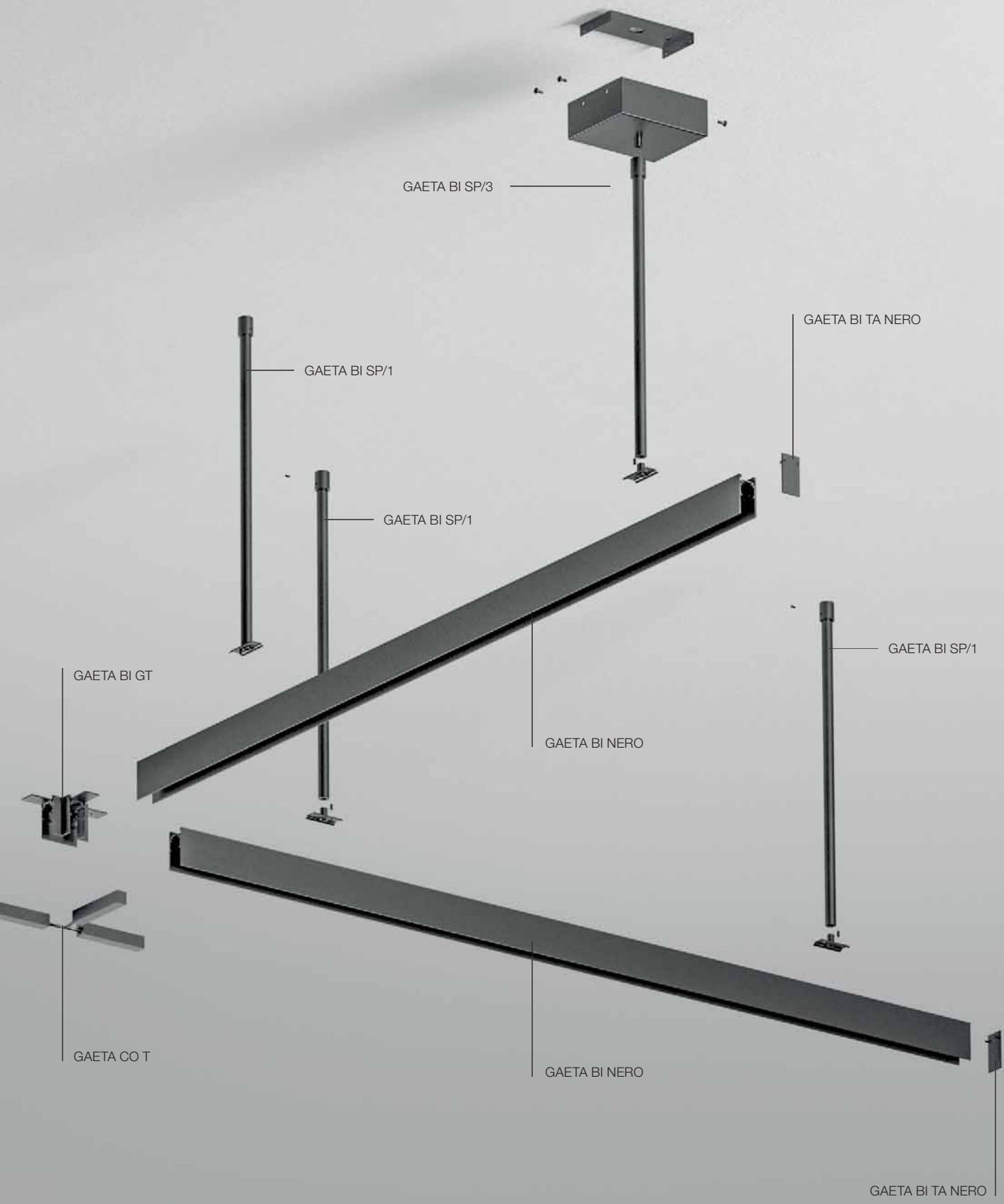



PROIETTORI BINARIO

Si possono inserire ed installare a binario, prodotti d'illuminazione di tipo lineare, spot proiettori, ed articoli a sospensione con una semplice pressione sulle due estremità dell'adattatore. Si possono far scorrere i prodotti fino al punto desiderato del binario con la massima sicurezza. Una gamma eterogenea di prodotti d'illuminazione con diverse specifiche e caratteristiche d'illuminamento: dalla luce d'accento alla luce diffusa, apparecchi che sapranno soddisfare qualsiasi esigenza di stile, forma e funzione.

Lighting tracks can fit linear lighting products, spotlights, floodlights, and pendant lamps - all inserted and installed by simply pressing the two ends of the adapter. Slide the products to the desired track point with maximum safety. A broad range of lighting products with different specifications and features: from accent lighting to diffused lighting, luminaires to meet any style, shape and functional requirement.

GORIZIA



Modulo di illuminazione LED non dimmerabile lineare a luce diffusa. Sistema ad incastro magnetico installabile nei binari 48V. Non è possibile installare il corpo illuminante negli angoli. Finiture: bianco o nero opaco.

Non dimmable linear LED lighting module with diffused light. Magnetic interlocking system that can be installed in 48V tracks. It is not possible to install the luminaire in corners. Finishes: matt white or black.



GORIZIA RE/P

Power: **7,2W**
 Input: **48V**
 Lumen: **335Lm**
 Optic: **120°**
 CRI: **>90**
 Light temp.: **3000°K**
 Pack: **0,0013 m³**

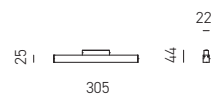

GORIZIA RE/M

Power: **14,4W**
 Input: **48V**
 Lumen: **732Lm**
 Optic: **120°**
 CRI: **>90**
 Light temp.: **3000°K**
 Pack: **0,0023 m³**

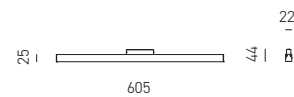

GORIZIA RE/G

Power: **28,8W**
 Input: **48V**
 Lumen: **1280Lm**
 Optic: **120°**
 CRI: **>90**
 Light temp.: **3000°K**
 Pack: **0,0045 m³**

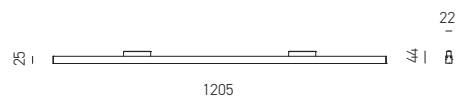

NEW

GORIZIA



Modulo di illuminazione LED non dimmerabile lineare regolabile a luce diffusa. Sistema ad incastro magnetico installabile nei binari 48V. Non è possibile installare il corpo illuminante negli angoli.
 Finiture: bianco o nero opaco.

Adjustable non dimmable linear LED lighting module with diffused light. Magnetic interlocking system that can be installed in 48V tracks. It is not possible to install the luminaire in corners.
 Finishes: matte white or black.

**GORIZIA RE/RP**

Power: **12W**
 input: **48V**
 Lumen: **370Lm**
 Beam Angle: **120°**
 CRI: **>90**
 Ligh. temp: **3000°K**
 Pack: **0,0009 m³**

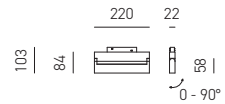

NEW

APRILIA



Modulo di illuminazione LED non dimmerabile lineare antiabbagliamento a luce diffusa. Sistema ad incastro magnetico installabile nei binari 48V. Non è possibile installare il corpo illuminante negli angoli. Finiture: bianco o nero opaco.

Non dimmable linear anti-glare LED lighting module with diffused light. Magnetic interlocking system that can be installed in 48V tracks. It is not possible to install the luminaire in corners. Finishes: matte white or black.

**APRILIA RE/P**

Power: **10W**
 input: **48V**
 Lumen: **880Lm**
 Beam Angle: **36°**
 CRI: **>90**
 Ligh. temp: **3000°K**
 Pack: **0,0003 m³**



NEW

APRILIA



Modulo di illuminazione LED non dimmerabile lineare regolabile antiabbagliamento a luce diffusa. Sistema ad incastro magnetico installabile nei binari 48V. Non è possibile installare il corpo illuminante negli angoli.
Finiture: bianco o nero opaco.

Adjustable non dimmable linear anti-glare LED lighting module with diffused light. Magnetic interlocking system that can be installed in 48V tracks. It is not possible to install the luminaire in corners.
Finishes: matte white or black.



APRILIA RE/RP

Power: **12W**
input: **48V**
Lumen: **880Lm**
Beam Angle: **36°**
CRI: **>90**
Ligh. temp: **3000°K**
Pack: **0,0009 m³**

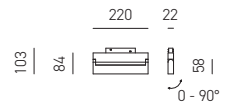

GENOVA



Modulo di illuminazione LED non dimmerabile con rotazione ed inclinazione regolabile. Sistema ad incastro magnetico installabile nei binari 48V. Non è possibile installare il corpo illuminante negli angoli. Finiture Genova: bianco o nero opaco.

Non dimmable LED lighting module with adjustable rotation and inclination. Magnetic interlocking system that can be installed in 48V tracks. It is not possible to install the luminaire in corners. Finishes Genova: matt white or black.



GENOVA SP

Power: **8,5W**
 Input: **48V**
 Lumen: **410Lm**
 Beam Angle: **40°**
 CRI: **>90**
 Light temp.: **3000°K**
 Pack: **0,0018 m³**

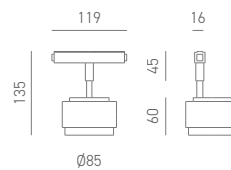

NARDÒ



Modulo di illuminazione LED non dimmerabile con rotazione ed inclinazione regolabile. Sistema ad incastro magnetico installabile nei binari 48V. Non è possibile installare il corpo illuminante negli angoli. Finiture Nardò: bianco o nero opaco, rame, oro o cromo.

Non dimmable LED lighting module with adjustable rotation and inclination. Magnetic interlocking system that can be installed in 48V tracks. It is not possible to install the luminaire in corners.

Finishes Nardò: matt white or black, copper, gold or chrome.



NARDÒ SP

Power: **8,5W**
 Input: **48V**
 Lumen: **410Lm**
 Beam Angle: **24°**
 CRI: **>90**
 Light temp.: **3000°K**
 Pack: **0,0017 m³**

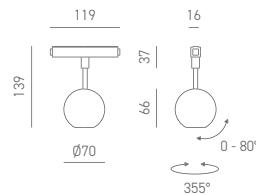

MODENA



Modulo di illuminazione LED non dimmerabile con rotazione ed inclinazione regolabile. Sistema ad incastro magnetico installabile nei binari 48V. Non è possibile installare il corpo illuminante negli angoli. Finiture Modena: bianco o nero opaco, oro o cromo

Non dimmable LED lighting module with adjustable rotation and inclination. Magnetic interlocking system that can be installed in 48V tracks. It is not possible to install the luminaire in corners.

Finishes Modena: matt white or black, gold or chrome.



MODENA SP/P

Power: **8W**
 Input: **48V**
 Lumen: **502Lm**
 Beam Angle: **24°**
 CRI: **>90**
 Light temp.: **3000°K**
 Pack: **0,0010 m³**

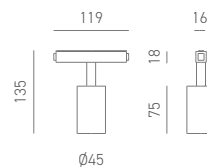

MODENA



Modulo di illuminazione LED non dimmerabile con rotazione ed inclinazione regolabile. Sistema ad incastro magnetico installabile nei binari 48V. Non è possibile installare il corpo illuminante negli angoli. Finiture Modena: bianco o nero opaco, oro o cromo

Non dimmable LED lighting module with adjustable rotation and inclination. Magnetic interlocking system that can be installed in 48V tracks. It is not possible to install the luminaire in corners.

Finishes Modena: matt white or black, gold or chrome.



MODENA SP/G

Power: **15W**
 Input: **48V**
 Lumen: **970Lm**
 Beam Angle: **24°**
 CRI: **>90**
 Light temp.: **3000°K**
 Pack: **0,0014 m³**

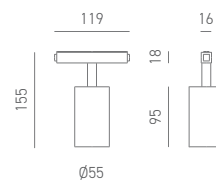

JESI



Modulo di illuminazione LED non dimmerabile con rotazione ed inclinazione regolabile. Sistema ad incastro magnetico installabile nei binari 48V. Non è possibile installare il corpo illuminante negli angoli. Finiture Jesi: bianco o nero opaco

Non dimmable LED lighting module with adjustable rotation and inclination. Magnetic interlocking system that can be installed in 48V tracks. It is not possible to install the luminaire in corners. Finishes Jesi: matt white or black



JESI SP

Power: **12W**
 Input: **48V**
 Lumen: **915Lm**
 Beam Angle: **38°**
 CRI: **>90**
 Light temp.: **3000°K**
 Pack: **0,0060 m³**

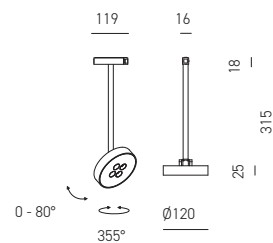

LIVORNO S



Moduli di illuminazione LED non dimmerabile a sospensione con cavo di lunghezza regolabile. Sistema ad incastro magnetico installabile nei binari 48V. Non è possibile installare il corpo illuminante negli angoli. Finiture Livorno: bianco o nero opaco, oro.

Non dimmable suspended LED lighting modules with adjustable length cable. Magnetic interlocking system that can be installed in 48V tracks. It is not possible to install the luminaire in corners. Finishes Livorno: matt white or black, gold.



LIVORNO S

Power: **7W**
 Input: **48V**
 Lumen: **325Lm**
 Beam Angle: **38°**
 CRI: **>90**
 Light temp.: **3000°K**
 Pack: **0,0019 m³**

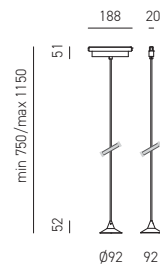

LORETO S



Moduli di illuminazione LED non dimmerabile a sospensione con cavo di lunghezza regolabile. Sistema ad incastro magnetico installabile nei binari 48V. Non è possibile installare il corpo illuminante negli angoli. Finiture Loreto: bianco o nero opaco, oro.

Non dimmable suspended LED lighting modules with adjustable length cable. Magnetic interlocking system that can be installed in 48V tracks. It is not possible to install the luminaire in corners. Finishes Loreto: matt white or black, gold.



LORETO S

Power: **7W**
 Input: **48V**
 Lumen: **213Lm**
 Beam Angle: **38°**
 CRI: **>90**
 Light temp.: **3000°K**
 Pack: **0,0033 m³**

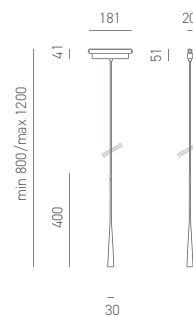

NARDÒ S



Moduli di illuminazione LED non dimmerabile a sospensione con cavo di lunghezza regolabile. Sistema ad incastro magnetico installabile nei binari 48V. Non è possibile installare il corpo illuminante negli angoli. Finiture Nardò: bianco o nero opaco, rame, oro o cromo

Non dimmable suspended LED lighting modules with adjustable length cable. Magnetic interlocking system that can be installed in 48V tracks. It is not possible to install the luminaire in corners. Finishes Nardò: matt white or black, copper, gold or chrome.



NARDÒ S

Power: **8,5W**
 Input: **48V**
 Lumen: **410Lm**
 Beam Angle: **36°**
 CRI: **>90**
 Light temp.: **3000°K**
 Pack: **0,0018 m³**

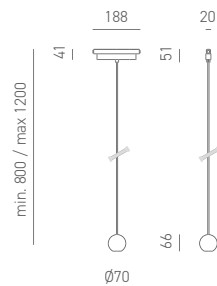

TECHNICAL INFORMATION

Sistema a binario modulare elettromeccanico 48V in alluminio sezionabile per installazione ad incasso. Lunghezza 2m. Finitura: bianco o nero opaco. Accessori non inclusi.

48V electromechanical modular track system in sectionable aluminium for recessed. Length 2m. Matt white or black finish. Accessories not included.



FIRENZE BI

Input: **48V**

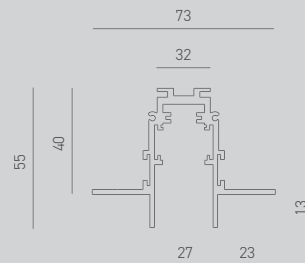

Angolo meccanico a 90° in alluminio per installazione soffitto/soffitto del sistema a binario modulare FIRENZE. Dotato già di giunti lineari per l'ancoraggio al binario. Finitura: bianco o nero opaco.

90° mechanical corner in aluminium for ceiling/ceiling installation of the FIRENZE modular track system. Already fitted with linear joints for coupling to the track. Matt white or black finish.

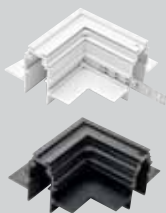

FIRENZE BI AV

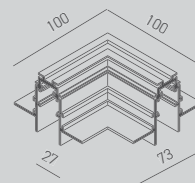

Angolo meccanico a 90° in alluminio per installazione parete/soffitto del sistema a binario modulare FIRENZE. Dotato già di giunti lineari per l'ancoraggio al binario. Finitura: bianco o nero opaco.

90° mechanical corner in aluminium for wall/ceiling installation of the FIRENZE modular track system. Already fitted with linear joints for coupling to the track. Matt white or black finish.



FIRENZE BI AO

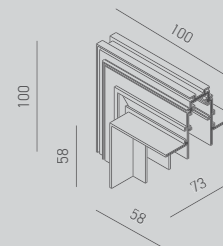

Giunzione meccanica a T in alluminio per installazione soffitto/soffitto o parete/parete del sistema modulare FIRENZE. Dotato già di giunti lineari per l'ancoraggio al binario. Finitura: bianco o nero opaco.

Mechanical aluminium T-joint for ceiling/ceiling or wall/wall installation of the FIRENZE modular system. Already fitted with linear joints for coupling to the track. Matte black or white finish.



FIRENZE BI GT

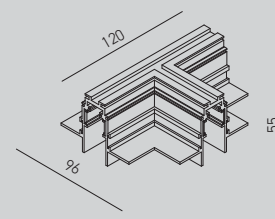

Giunto lineare in metallo galvanizzato per l'ancoraggio del sistema a binario modulare FIRENZE. Utilizzare 2 staffe per ogni ancoraggio di 2 binari.

Linear joint in galvanised metal for anchoring the FIRENZE modular track system. Use 2 brackets for each 2 track anchor.



FIRENZE BI ST

Copertura ad incastro per l'alimentatore
ad incastro diretto GAETA TR.
Lunghezza 27 cm.
Finiture: bianco o nero opaco.

Interlocking cover for the GAETA TR
interlocking direct power supply.
Length 27 cm.
Finishes: matt white or black.



GAETA COV



Copertura ad incasso per binario.
Lunghezza 2 metri.
Finiture: bianco o nero opaco.

Interlocking cover for track.
Length 2 meters.
Finishes: matt white or black.

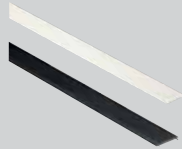

GAETA COV 2



Tappe di chiusura singolo in metallo per
sistema a binario modulare FIRENZE.
Finiture: bianco o nero opaco.

Single metal closing cap for FIRENZE
modular track system.
Finishes: matt white or black.



FIRENZE BI TA



TECHNICAL INFORMATION

Sistema a binario modulare elettromeccanico 48V in alluminio sezionabile per installazione di superficie. Lunghezza 2m. Finitura: bianco o nero opaco. Accessori non inclusi.

48V electromechanical modular track system in sectionable aluminium for surface installation. Length 2m. Matt white or black finish. Accessories not included.



GAETA BI

Input: **48V**

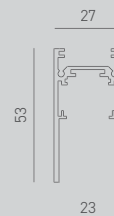

Angolo meccanico a 90° in alluminio per installazione soffitto/soffitto del sistema a binario modulare GAETA. Dotato già di giunti lineari per l'ancoraggio al binario. Finitura: bianco o nero opaco.

90° mechanical corner in aluminium for ceiling/ceiling installation of the GAETA modular track system. Already fitted with linear joints for coupling to the track. Matt white or black finish.



GAETA BI AV

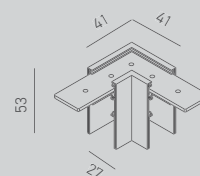

Angolo meccanico a 90° in alluminio per installazione parete/soffitto del sistema a binario modulare GAETA. Finitura: bianco o nero opaco.

90° mechanical corner in aluminium for wall/ceiling installation of the GAETA modular track system. Matt white or black finish.



GAETA BI AO

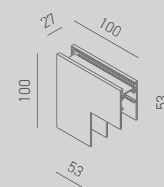

Giunzione meccanica a T in alluminio per installazione soffitto/soffitto o parete/parete del sistema modulare GAETA. Dotato già di giunti lineari per l'ancoraggio al binario. Finitura: bianco o nero opaco.

Mechanical aluminium T-joint for ceiling/ceiling or wall/wall installation of the GAETA modular system. Already fitted with linear joints for coupling to the track. Matte black or white finish.



GAETA BI GT

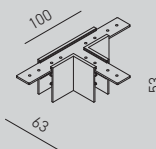

Giunto lineare in metallo per l'ancoraggio del sistema a binario modulare GAETA. Utilizzare 1 staffa per ogni ancoraggio di 2 binari. Finitura: bianco o nero opaco.

Linear joint in galvanised metal for anchoring the GAETA modular track system. Use 1 bracket for each 2 track anchor. Matt white or black finish.



GAETA BI ST



Copertura ad incastro per l'alimentatore ad incastro diretto GAETA TR. Lunghezza 27 cm. Finiture: bianco o nero opaco.

Interlocking cover for the GAETA TR interlocking direct power supply. Length 27 cm. Finishes: matt white or black.

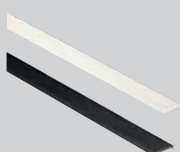

GAETA COV



Copertura ad incasso per binario. Lunghezza 2 metri. Finiture: bianco o nero opaco.

Interlocking cover for track. Length 2 meters. Finishes: matt white or black.

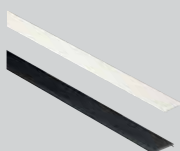

GAETA COV 2



Tappo di chiusura singolo in metallo per sistema a binario modulare GAETA.
Finiture: bianco o nero opaco.

Single metal closing cap for GAETA modular track system.
Finishes: matt white or black.



GAETA BI TA



Kit tiges singolo da 45cm senza rosone per sospensione binario GAETA.
Da abbinare con un GAETA SP/3.
Finiture: bianco o nero opaco.

45 cm single tiges kit without ceiling rose for GAETA track suspension.
To be matched with a GAETA SP/3.
Finishes: matt white or black.



GAETA BI SP/1

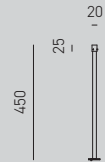

Kit tiges singolo da 75cm senza rosone per sospensione binario GAETA.
Da abbinare con un GAETA SP/4.
Finiture: bianco o nero opaco.

75 cm single tiges kit without ceiling rose for GAETA track suspension.
To be matched with a GAETA SP/4.
Finishes: matt white or black.

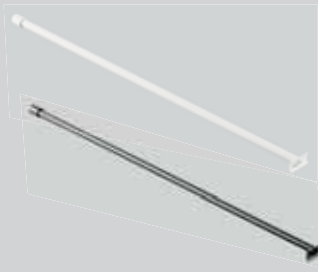

GAETA BI SP/2



Kit tiges singolo da 45cm con rosone per sospensione binario GAETA.
Da abbinare con un GAETA SP/1.
Indispensabile l'utilizzo di alimentatori in remoto e GAETA CO S.
Finiture: bianco o nero opaco.

45 cm single tiges kit with ceiling rose for GAETA track suspension.
To be matched with a GAETA SP/1.
It is essential to use remote power supplies and GAETA CO S.
Finishes: matt white or black.



GAETA BI SP/3

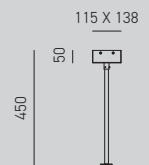

Kit tiges singolo da 75cm con rosone per sospensione binario GAETA.
Da abbinare con un GAETA SP/2.
Indispensabile l'utilizzo di alimentatori in remoto e GAETA CO S.
Finiture: bianco o nero opaco.

Single 75 cm tiges kit with ceiling rose for GAETA track suspension.
To be matched with a GAETA SP/2.
It is essential to use remote power supplies and GAETA CO S.
Finishes: matt white or black.

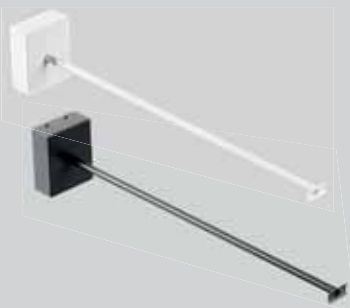

GAETA BI SP/4

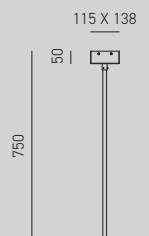

TECHNICAL INFORMATION

Modulo di connessione elettrica per alimentazione in remoto con cavo da 80cm. Indispensabile per il funzionamento degli alimentatori GAETA TR R1 o GAETA TR R2. Finiture: bianco o nero opaco.

Electrical connection module for remote power supply with 80 cm cable. Essential for the operation of power supplies GAETA TR R1 or GAETA TR R2. Finishes: matt white or black.



GAETA CO S

Input: **48V**

Modulo di connessione elettrica di 2 binari FIRENZE o GAETA per installazione lineare o angolare. Finiture: bianco o nero opaco.

Electrical connection module of 2 FIRENZE or GAETA tracks for linear or corner installation. Finishes: matt white or black.

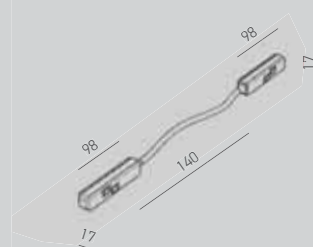

GAETA CO D

Input: **48V**

Modulo di connessione elettrica di 3 binari FIRENZE o GAETA per installazione lineare o angolare. Finiture: bianco o nero opaco.

Electrical connection module of 3 FIRENZE or GAETA tracks for linear or corner installation. Finishes: matt white or black.

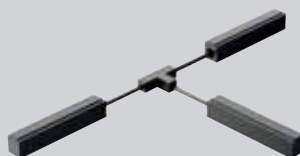

GAETA CO T

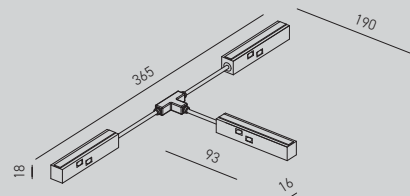

Alimentatore ad incastro magnetico diretto per binari FIRENZE o GAETA.

Direct magnetic interlocking power supply for FIRENZE or GAETA tracks.



GAETA TR

Input
V **220-240V**
A **0,4 A**
Hz **50/60 Hz**
Output
W **60 W**
V **48 V dc**
A **1,25 A**

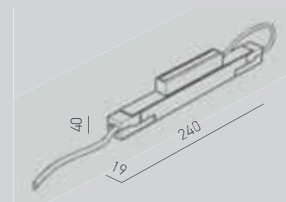

Alimentatore in remoto per binari FIRENZE o GAETA. Indispensabile per il funzionamento il connettore GAETA CO S.

Remote power supply for FIRENZE or GAETA tracks. The GAETA CO S connector is essential for operation.



GAETA TR R1

Input
V **220-240V**
A **350-380mA**
Hz **50/60 Hz**
Output
W **75W**
V **48 V**
A **1,563 A**

GAETA TR R2

Input
V **550-600mA**
A **0,5A**
Hz **50/60 Hz**
Output
W **120W**
V **48 V**
A **4,8 A**

GAETA TR R1



GAETA TR R2

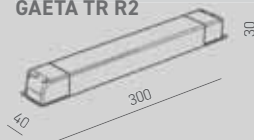

Alimentatore ad incastro magnetico diretto per binari FIRENZE o GAETA. Non è possibile utilizzare il GAETA COV o il GAETA COV 2 per coprirlo.

Direct magnetic interlocking power supply for FIRENZE or GAETA tracks. GAETA COV or GAETA COV 2 cannot be used to cover it.



GBITR1

Input
V **220-240V**
A **0,5 A**
Hz **50/60 Hz**
Output
W **100W**
V **48V**
A **2 A**

GBITR2

Input
V **220-240V**
A **1 A**
Hz **50/60 Hz**
Output
W **200W**
V **48V**
A **4 A**

GBITR1

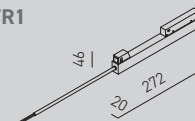

GBITR2

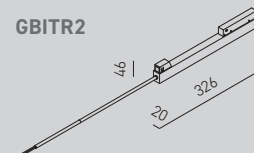

BINARIO MAGNETICO B.T. DA INCASSO LOW VOLTAGE MAGNETIC RECESSED TRACK

Alimentazione e connessione sono elementi indispensabili per il corretto funzionamento del sistema binario da incasso. Nelle immagini qui a lato ne raffiguriamo un sintetico e corretto utilizzo.

The power supply unit and the connection are required for the proper operation of the recessed track system. Check the figures on the side for a proper use scheme.



BINARIO MAGNETICO B.T. DI SUPERFICIE LOW VOLTAGE MAGNETIC SURFACE TRACK

Abbina la miglior soluzione degli alimentatori e delle connessioni in base allo sviluppo ed alla configurazione del tuo sistema binario.

Collega tra loro due o più barre di binario, utilizzando i nostri componenti dedicati, collegando l'alimentazione dalla testa o da qualsiasi altro punto del binario, come illustrato nelle immagini a fianco.

Match the best power supply unit and connection to the development and configuration of your track system. Connect several track bars together using our dedicated components, connecting the power supply unit from the head or from any other track point, as shown in the side figures.







COORDINATI

GUYA

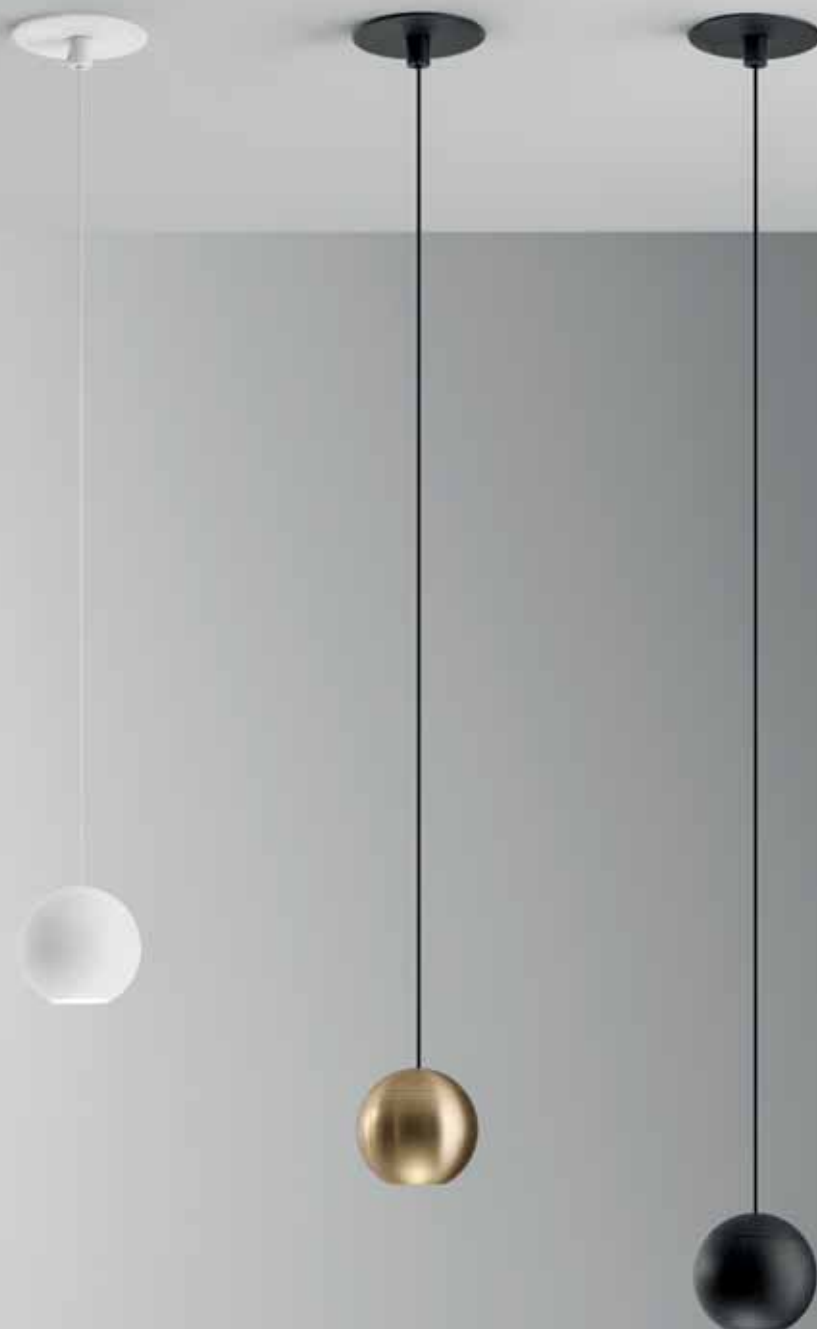

Luce d'accento a tutto tondo
All-round accent light









IL SUO DESIGN
SODDISFA OGNI
RICHIESTA DI STILE
CONTEMPORANEO
O TRADIZIONALE
GRAZIE AD UNA
FORMA GEOMETRICA
PRATICAMENTE
VERSATILE E PERFETTA.

ITS DESIGN SATISFIES
ANY REQUEST FOR
CONTEMPORARY
OR TRADITIONAL
STYLE THANKS TO
A PRACTICALLY
VERSATILE AND PERFECT
GEOMETRIC SHAPE.





GUYA

Sospensione singola con montatura in alluminio disponibile da incasso o con rosone.

Sospensione multipla lineare a 3 luci.
 Finiture: bianco satinato con rosone bianco satinato; nero satinato con rosone nero satinato; oro con rosone nero satinato.
 Sorgente luminosa led non dimmerabile ed alimentatore inclusi.

Single suspension with aluminum frame available as recessed or with canopy.
 Finishes: satin white with satin white canopy; satin black with satin black canopy; gold with satin black canopy.
 Non dimmable LED light source and driver included.

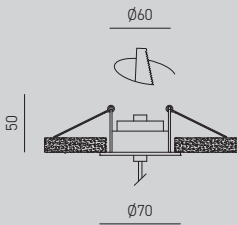

GUYA S/1

Socket: **1 modulo LED**
 Power: **8,5W**
 input: **220/240V**
 Lumen: **410Lm**
 Beam angle: **36°**
 CRI: **>90**
 Light temp.: **3000°K**
 Pack: **0,0018 m³**

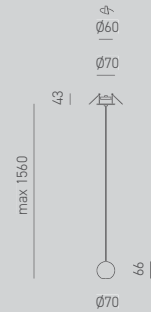

GUYA S/1

Socket: **1 modulo LED**
 Power: **8,5W**
 input: **220/240V**
 Lumen: **410Lm**
 Beam angle: **36°**
 CRI: **>90**
 Light temp.: **3000°K**
 Pack: **0,002 m³**

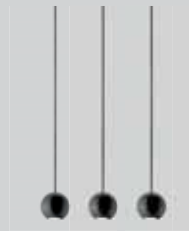

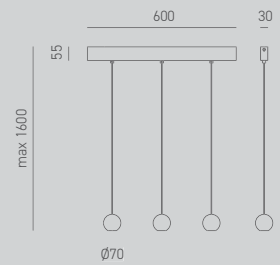

GUYA S/3

Socket: **3 moduli LED**
 Power: **24W**
 input: **220/240V**
 Lumen: **1525Lm**
 Beam angle: **36°**
 CRI: **>90**
 Light temp.: **3000°K**
 Pack: **0,007 m³**



FINISHING

 **Bianco Satinato - Bianco Satinato**
 Satin White - Satin White

 **Nero Satinato - Nero Satinato**
 Satin Black - Satin Black

 **Oro - Nero Satinato**
 Gold - Satin Black

DAFNE



Una sottile eleganza in sospensione
An elegant pendant lamp





LA SUA LUCE DIRETTA,
MA NON INVASIVA
ASSICURA UN CONFORT
VISIVO IDEALE PER
QUALSIASI SUA
INSTALLAZIONE.

ITS DIRECT BUT
NON-INVASIVE LIGHT
ENSURES IDEAL VISUAL
COMFORT ON ANY
INSTALLATION.



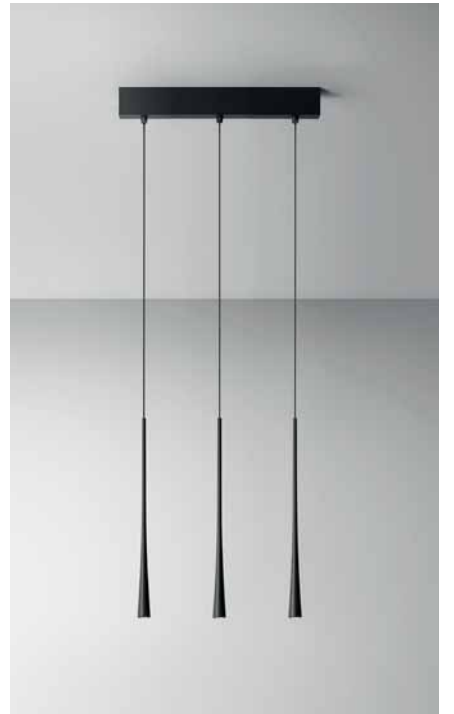





DAFNE

Sospensione singola con montatura in alluminio disponibile da incasso o con rosone.

Sospensione multipla lineare a 3 luci.
 Finiture: bianco satinato con rosone bianco satinato; nero satinato con rosone nero satinato; oro con rosone nero satinato.
 Sorgente luminosa led non dimmerabile ed alimentatore inclusi.

Single suspension with aluminum frame available as recessed or with canopy.
 Finishes: satin white rose; satin black with satin black rose; gold with satin black rose.
 Non dimmable LED light source and driver included.

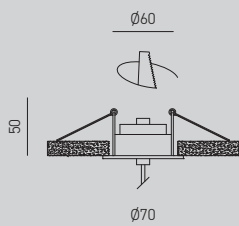

DAFNE SP/I

Socket: **1 modulo LED**
 Power: **7W**
 input: **220/240V**
 Lumen: **213Lm**
 Optic: **38°**
 CRI: **>90**
 Light temp.: **3000°K**
 Pack: **0,008 m³**



DAFNE S/P

Socket: **1 modulo LED**
 Power: **7W**
 input: **220/240V**
 Lumen: **213Lm**
 Optic: **38°**
 CRI: **>90**
 Light temp.: **3000°K**
 Pack: **0,003 m³**



DAFNE S/G

Socket: **1 modulo LED**
 Power: **7W**
 Input: **220/240V**
 Lumen: **213Lm**
 Optic: **38°**
 CRI: **>90**
 Light temp.: **3000°K**
 Pack: **0,005 m³**

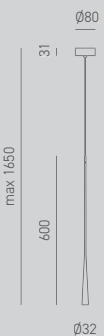



DAFNE S/3P

Socket: **3 moduli LED**
 Power: **16,5W**
 input: **220/240V**
 Lumen: **612Lm**
 Optic: **38°**
 CRI: **>90**
 Light temp.: **3000°K**
 Pack: **0,008 m³**



FINISHING

 **Bianco Satinato - Bianco Satinato**
 Satin White - Satin White

 **Nero Satinato - Nero Satinato**
 Satin Black - Satin Black

 **Oro - Nero Satinato**
 Gold - Satin Black

HELENA



Piccole dimensioni, grande design
Small size with a great design





UNA PICCOLA
SOSPENSIONE
MINIATURIZZATA,
UNA GRANDE ANIMA
LUMINOSA CHE SAPRÀ
CARATTERIZZARRE I
VOSTRI SPAZI.

A SMALL
MINIATURISED
PENDANT LIGHT
WITH A LARGE AND
LUMINOUS SOUL TO
FLOOD YOUR SPACES.

HELENA

Sospensioni con montatura in alluminio.
 Finiture: bianco satinato con rosone
 bianco satinato; nero satinato con rosone
 nero satinato;
 Sorgente luminosa led non dimmerabile ed
 alimentatore inclusi.

Suspension lighting with aluminium frame.
 Finishes: satin white with satin white canopy;
 satin black with satin black canopy;
 Non dimmable LED light source and driver
 included.



HELENA S/1

Socket: **1 modulo LED**
 Power: **7W**
 Input: **220/240V**
 Lumen: **325Lm**
 Optic: **38°**
 CRI: **>90**
 Light temp.: **3000°K**
 Pack: **0,002 m³**



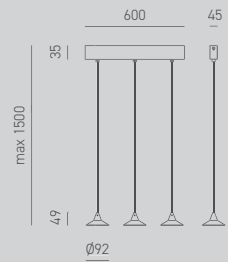

HELENA S/3

Socket: **3 moduli LED**
 Power: **16,5W**
 Input: **220/240V**
 Lumen: **920Lm**
 Optic: **38°**
 CRI: **>90**
 Light temp.: **3000°K**
 Pack: **0,009 m³**



FINISHING

 **Bianco Satinato - Bianco Satinato**
 Satin White - Satin White

 **Nero Satinato - Nero Satinato**
 Satin Black - Satin Black

NEW

OFELIA



**Originalità della tecnica realizzativa
per un design innovativo**
An original manufacturing technique creates this
innovative design









FORME ESSENZIALI, CARATTERIZZATE DALLA LAVORAZIONE DI DUE TIPI DI VETRO CHE SI AVVOGONO E RICOPRONO. UN DESIGN INNOVATIVO CHE CONVINCE ED ATTRAIE PER ORIGINALITÀ E TECNICA REALIZZATIVA. UN VETRO INTERNO SATINATO CHE DIFFONDE OMOGENEAMENTE LA LUCE, PROTETTO E RIVESTITO DA UN SECONDO VETRO TRASPARENTE, COLORATO TRASPARENTE O CON FINITURA SPECCHIO.

ESSENTIAL FORMS MADE FROM TWO TYPES OF GLASS THAT ENVELOP AND COVER EACH OTHER. AN INNOVATIVE DESIGN WITH CAPTIVATING ORIGINALITY AND TECHNICAL REALISATION. THE FROSTED INTERNAL GLASS EVENLY DIFFUSES THE LIGHT, PROTECTED AND COVERED BY A SECOND TRANSPARENT PANE, EITHER COLOURED TRANSPARENT OR WITH A MIRROR FINISH.









SPENTO O ACCESO,
È BELLO DI GIORNO
E STUPEFACENTE DI
NOTTE. LE FINITURE
SPECCHIO NEI COLORI
ORO, CROMO E RAME
CHE, SOLO DA ACCESE,
RIVELANO LA PRESENZA
DEL CONO DI LUCE
INTERNO, ESALTANO
CROMATICAMENTE
QUESTA COLLEZIONE
E REGALANO UN
ORIGINALE DETTAGLIO,
DA SCOPRIRE AL
MOMENTO GIUSTO.

OFF OR ON, IT'S
BEAUTIFUL BY DAY AND
AMAZING BY NIGHT.
THE MIRROR FINISHES
IN GOLD, CHROME OR
COPPER - WHICH ONLY
REVEAL THE INNER
LIGHT CONE WHEN THE
LIGHT IS SWITCHED
ON - ADD A TOUCH
OF COLOUR TO THE
COLLECTION AND ARE
AN ORIGINAL DETAIL TO
BE DISCOVERED AT THE
RIGHT TIME.









LA VERSIONE TRASPARENTE
COLORATA, SEMBRA RICORDARE
UNA FINITURA AD ACQUARELLO,
TINTE TENUI E DELICATE,
ARMONICAMENTE COMBinate
NEL MIX DELLE COMBINAZIONI
MULTIPLE.

THE TRANSPARENT COLOURED
VERSION GIVES A WATERCOLOUR
EFFECT WITH ITS SOFT AND DELICATE
COLOURS, HARMONIOUSLY
MERGED IN A MIX OF MULTIPLE
COMBINATIONS.







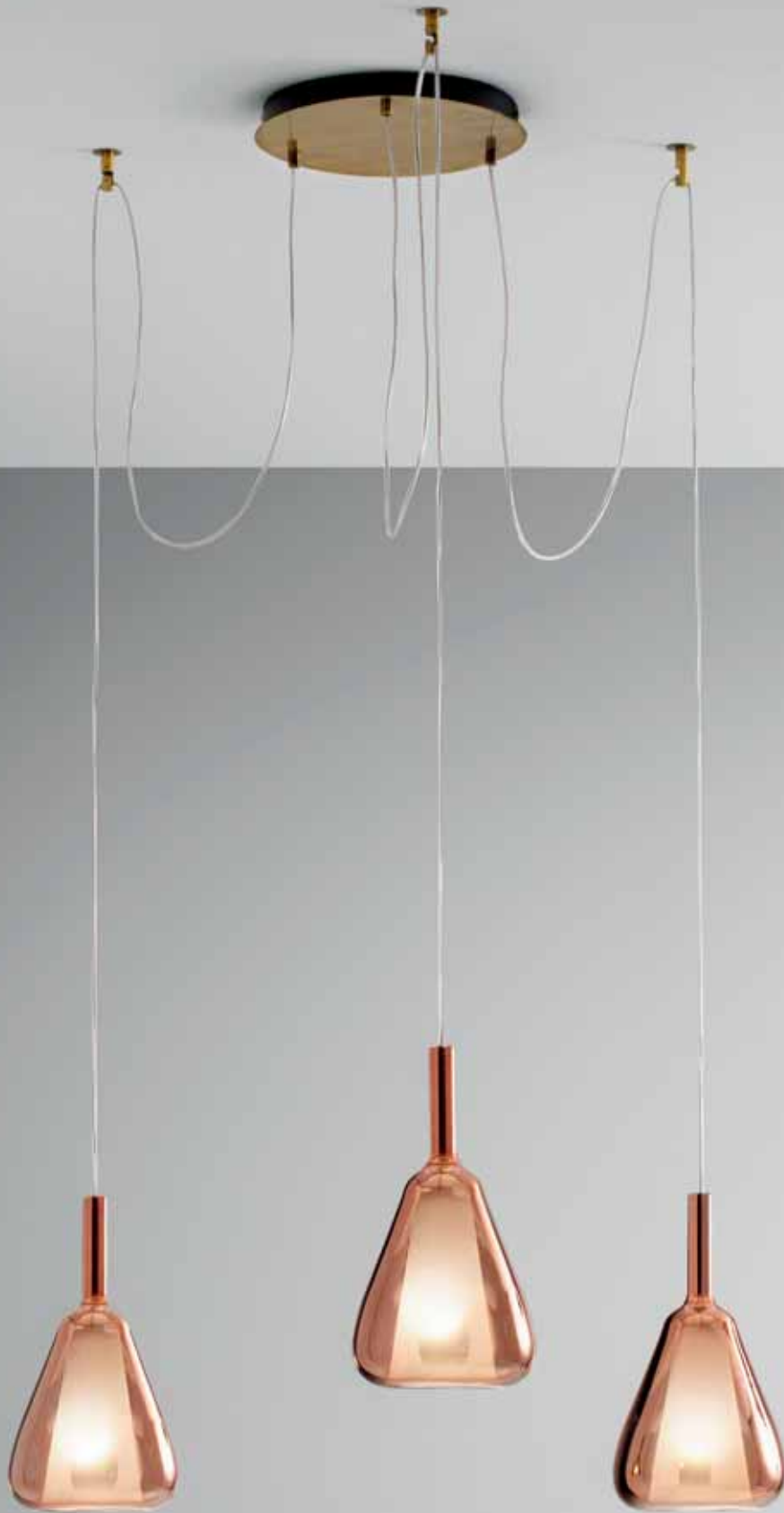





OFELIA KIT

Vetro borosilicato con incluso portalampade E27 bianco e cavo in PVC trasparente lunghezza 3 metri.

Non incluso di rosone.

Finiture: Trasparente, Blu trasparente, Verde trasparente, Ambra trasparente, Rame specchiato, Cromo specchiato o Oro specchiato.

Lampadina non inclusa.

Borosilicate glass with white E27 lamp-holder and transparent 3-metre-long PVC cable included. Ceiling rose not included.

Finishes: Clear, Clear blue, Clear green, Clear amber, Mirrored copper, Mirrored chrome or Mirrored gold.

Bulb not included.



OFELIA S/10

Socket: **1xE27**
Power: **max 60W**
input: **220/240V**
Pack: **0,031 m³**

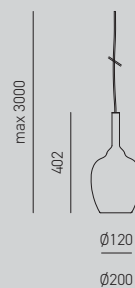

OFELIA S/11

Socket: **1xE27**
Power: **max 60W**
input: **220/240V**
Pack: **0,031 m³**

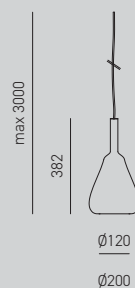

OFELIA S/12

Socket: **1xE27**
Power: **max 60W**
input: **220/240V**
Pack: **0,035 m³**



ESEMPIO ORDINE

ESEMPIO ORDINE



1 ALICE B T/6
x 1 pz.









2 GSUBL11
x 6 pz.



3 OFELIA S/10
x 2 pz.
OFELIA S/11
x 2 pz.
OFELIA S/12
x 2 pz.



GLASSES

-  **Trasparente / Clear**
-  **Blu Trasparente / Clear Blue**
-  **Verde Trasparente / Clear Green**
-  **Ambra Trasparente / Clear Amber**
-  **Rame Specchiato / Mirrored Copper**
-  **Cromo Specchiato / Mirrored Chrome**
-  **Oro Specchiato / Mirrored Gold**

OFELIA KIT

Rosone tondo ad un foro in metallo con staffa e accessori per il fissaggio inclusi. Incluso di pressacavo e morsettiera elettrica. Finiture: bianco opaco, ottone o nero opaco.

Round one-hole metal ceiling rose with bracket and fixing accessories included. Includes cable gland and electrical terminal block. Finishes: matte white, brass or matte black.



ALICE B/1

Pack: **0,0005 m³**



Rosone rettangolare a tre fori in metallo con staffa ed accessori per il fissaggio inclusi. Inclusi tre pressacavi e morsettiera elettrica. Finiture: Bianco opaco, ottone o nero opaco.

Three-hole, rectangular metal ceiling rose with bracket and fixing accessories included. Includes three cable glands and electrical terminal block. Finishes: Matt white; brass or matt black.

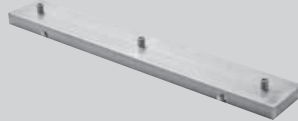

ALICE B R/3

Pack: **0,0059 m³**

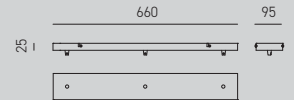

Rosone a tre fori in metallo con staffa ed accessori per il fissaggio inclusi. Inclusi tre pressacavi e morsettiera elettrica. Finiture: Bianco opaco, ottone o nero opaco.

Three-hole metal ceiling rose with bracket and fixing accessories included. Includes three cable glands and electrical terminal block. Finishes: Matt white; brass or matt black.



ALICE B T/3

Pack: **0,0092 m³**

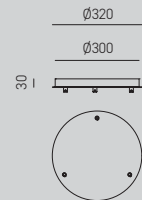

Rosone a sei fori in metallo con staffa ed accessori per il fissaggio inclusi. Inclusi tre pressacavi e morsettiera elettrica. Finiture: Bianco opaco, ottone o nero opaco.

Six-hole metal ceiling rose with bracket and fixing accessories included. Includes six cable glands and electrical terminal block. Finishes: Matt white; brass or matt black.



ALICE B T/6

Pack: **0,027 m³**

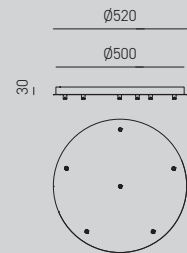

Decentratore in metallo con aggancio e fissaggio con grano per cavi 2x0,75mm. Finiture: Bianco opaco, ottone o nero opaco.

Metal decentralizer with hook and dowel fitting for 2x0.75mm cables. Finishes: Matt white; brass or matt black.



GSOBL10 Bianco Opaco / White Matt

GSOBL11 Nero Opaco / Black Matt

GSOBL12 Ottone / Brass

Pack: **0,00019 m³**



Decentratore in metallo con regolazione per cavi elettrici.

Metal decentralizations with adjustment for electric cables.



GSOBL01 Bianco Opaco / White Matt

GSOBL02 Nero Opaco / Black Matt

GSOBL03 Ottone / Brass

Pack: **0,00002 m³**



 Bianco Opaco / Matt White

 Nero Opaco / Matt Black

 Ottone / Brass

NEW

RAIKA



Trasparenze di magiche atmosfere d'oriente
Transparencies with a magical Oriental mood























RAIKA KIT

Vetro soffiato con decorazione a coste verticali disponibile in 2 misure: diametro 12cm o 15cm.

Finiture: Trasparente, Blu trasparente, Verde trasparente, Ambra trasparente, Bianco opale, Rame specchiato, Cromo specchiato o Oro specchiato. Lampadina non inclusa.

Blown glass with vertical ribbed decoration available in 2 sizes: 12 cm or 15 cm diameter. Finishes: Clear, Clear blue, Clear green, Clear amber, Opal white, Mirrored copper, Mirrored chrome or Mirrored gold. Bulb not included.



RAIKA V/P

Pack: **0,013 m³**



RAIKA V/G

Pack: **0,016 m³**



Montatura in plastica ed alluminio senza rosone dotata di cavo elettrico 2x0,75mm rivestito in stoffa. Lunghezza 3 metri.

Finitura: bianco o nero.

Plastic and aluminium frame without ceiling rose fitted with 2x0.75 mm cloth-covered electrical cable. Length 3 metres. Matte white or black finish.



NUMA M SR

Socket: **1xE27**
Power: **max 60W**
input: **220/240V**
Pack: **0,0012 m³**



ESEMPIO ORDINE

ESEMPIO ORDINE

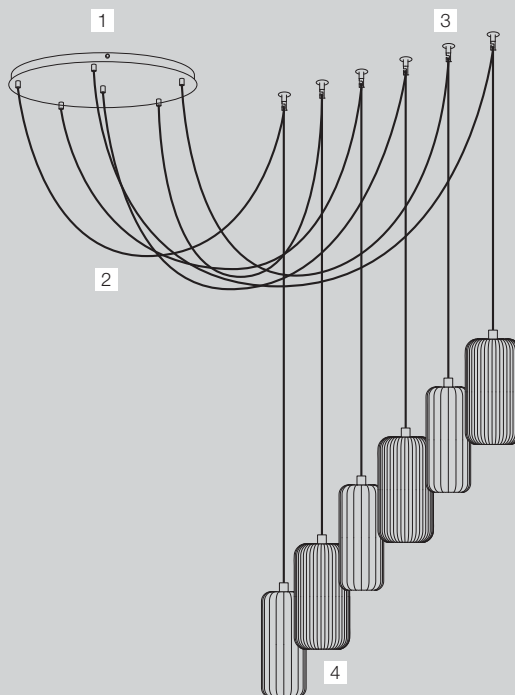

1 ALICE B T/6
x 1 pz.



2 NUMA M SR
x 6 pz.



3 GS0BL11
x 6 pz.











4 RAIKA V/P
x 3 pz.



RAIKA V/G
x 3 pz.

GLASSES

-  **Trasparente / Clear**
-  **Blu Trasparente / Clear Blue**
-  **Verde Trasparente / Clear Green**
-  **Ambra Trasparente / Clear Amber**
-  **Bianco Opale / Opal White**
-  **Rame Specchiato / Mirrored Copper**
-  **Cromo Specchiato / Mirrored Chrome**
-  **Oro Specchiato / Mirrored Gold**

RAIKA KIT

Rosone tondo ad un foro in metallo con staffa e accessori per il fissaggio inclusi. Incluso di pressacavo e morsettiera elettrica. Finiture: bianco opaco, ottone o nero opaco.

Round one-hole metal ceiling rose with bracket and fixing accessories included. Includes cable gland and electrical terminal block. Finishes: matte white, brass or matte black.



ALICE B/1

Pack: **0,0005 m³**



Rosone rettangolare a tre fori in metallo con staffa ed accessori per il fissaggio inclusi. Inclusi tre pressacavi e morsettiera elettrica. Finiture: Bianco opaco, ottone o nero opaco.

Three-hole, rectangular metal ceiling rose with bracket and fixing accessories included. Includes three cable glands and electrical terminal block. Finishes: Matt white; brass or matt black.

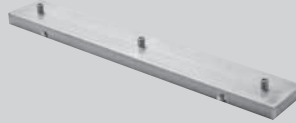

ALICE B R/3

Pack: **0,0059 m³**

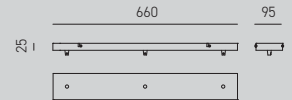

Rosone a tre fori in metallo con staffa ed accessori per il fissaggio inclusi. Inclusi tre pressacavi e morsettiera elettrica. Finiture: Bianco opaco, ottone o nero opaco.

Three-hole metal ceiling rose with bracket and fixing accessories included. Includes three cable glands and electrical terminal block. Finishes: Matt white; brass or matt black.



ALICE B T/3

Pack: **0,0092 m³**

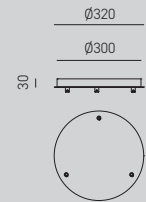

Rosone a sei fori in metallo con staffa ed accessori per il fissaggio inclusi. Inclusi tre pressacavi e morsettiera elettrica. Finiture: Bianco opaco, ottone o nero opaco.

Six-hole metal ceiling rose with bracket and fixing accessories included. Includes six cable glands and electrical terminal block. Finishes: Matt white; brass or matt black.



ALICE B T/6

Pack: **0,027 m³**

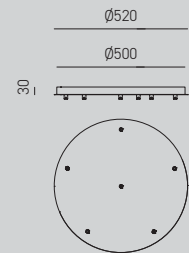

Decentratore in metallo con aggancio e fissaggio con grano per cavi 2x0,75mm. Finiture: Bianco opaco, ottone o nero opaco.

Metal decentralizer with hook and dowel fitting for 2x0.75mm cables. Finishes: Matt white; brass or matt black.



GSOBL10 Bianco Opaco / White Matt

GSOBL11 Nero Opaco / Black Matt

GSOBL12 Ottone / Brass

Pack: **0,00019 m³**



Decentratore in metallo con regolazione per cavi elettrici.

Metal decentralizations with adjustment for electric cables.



GSOBL01 Bianco Opaco / White Matt

GSOBL02 Nero Opaco / Black Matt

GSOBL03 Ottone / Brass

Pack: **0,00002 m³**



FINISHING

 Bianco Opaco / Matt White

 Nero Opaco / Matt Black

 Ottone / Brass

NEW

NUMA



Romantic trasparenze dal sapore retrò
Romantic transparencies with a retro feel























NUMA KIT

Vetro con decorazione a coste verticali.
 Finiture: Trasparente, Blu trasparente,
 Verde trasparente, Ambra trasparente o
 Bianco opale.
 Lampadina non inclusa.

Glass with vertical ribbed decoration.
 Finishes: Clear, Clear blue, Clear green,
 Clear Amber or Opal white.
 Bulb not included.

Montatura in plastica ed alluminio senza
 rosone dotata di cavo elettrico 2x0,75mm
 rivestito in stoffa. Lunghezza 3 metri.
 Finitura: bianco o nero.

Plastic and aluminium frame without ceiling
 rose fitted with 2x0.75 mm cloth-covered
 electrical cable. Length 3 metres.
 Matte white or black finish.



NUMA V/P

Pack: **0,025 m³**

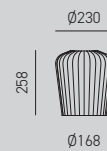

NUMA M SR

Socket: **1xE27**
 Power: **max 60W**
 input: **220/240V**
 Pack: **0,0012 m³**



ESEMPIO ORDINE ESEMPIO ORDINE

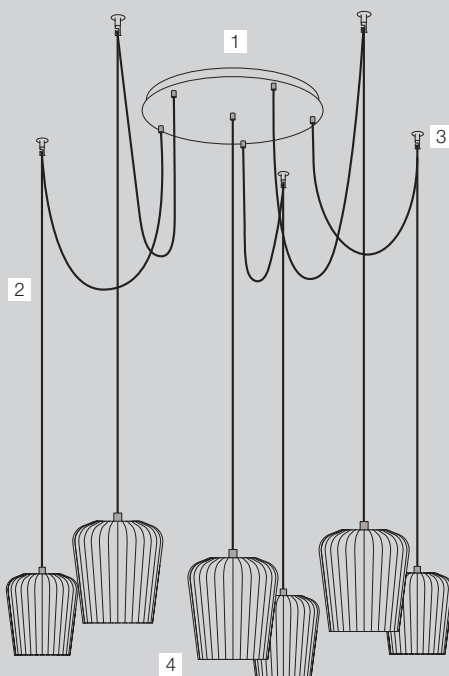

1 ALICE B T/6
 x 1 pz.



2 NUMA M SR
 x 6 pz.



3 GSOBL11
 x 6 pz.



4 NUMA VP
 x 6 pz.



GLASSES

-  **Trasparente / Clear**
-  **Blu Trasparente / Clear Blue**
-  **Verde Trasparente / Clear Green**
-  **Ambra Trasparente / Clear Amber**
-  **Bianco Opale / Opal White**

NUMA KIT

Rosone tondo ad un foro in metallo con staffa e accessori per il fissaggio inclusi. Incluso di pressacavo e morsettiera elettrica. Finiture: bianco opaco, ottone o nero opaco.

Round one-hole metal ceiling rose with bracket and fixing accessories included. Includes cable gland and electrical terminal block. Finishes: matte white, brass or matte black.



ALICE B/1

Pack: **0,0005 m³**

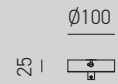

Rosone rettangolare a tre fori in metallo con staffa ed accessori per il fissaggio inclusi. Inclusi tre pressacavi e morsettiera elettrica. Finiture: Bianco opaco, ottone o nero opaco.

Three-hole, rectangular metal ceiling rose with bracket and fixing accessories included. Includes three cable glands and electrical terminal block. Finishes: Matt white; brass or matt black.

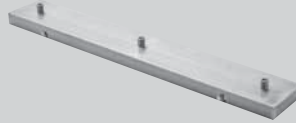

ALICE B R/3

Pack: **0,0059 m³**

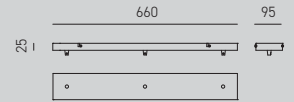

Rosone a tre fori in metallo con staffa ed accessori per il fissaggio inclusi. Inclusi tre pressacavi e morsettiera elettrica. Finiture: Bianco opaco, ottone o nero opaco.

Three-hole metal ceiling rose with bracket and fixing accessories included. Includes three cable glands and electrical terminal block. Finishes: Matt white; brass or matt black.



ALICE B T/3

Pack: **0,0092 m³**

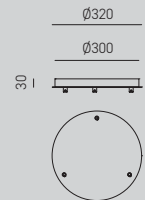

Rosone a sei fori in metallo con staffa ed accessori per il fissaggio inclusi. Inclusi tre pressacavi e morsettiera elettrica. Finiture: Bianco opaco, ottone o nero opaco.

Six-hole metal ceiling rose with bracket and fixing accessories included. Includes six cable glands and electrical terminal block. Finishes: Matt white; brass or matt black.



ALICE B T/6

Pack: **0,027 m³**

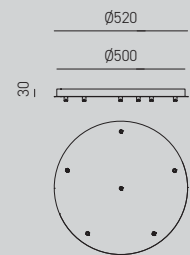

Decentratore in metallo con aggancio e fissaggio con grano per cavi 2x0,75mm. Finiture: Bianco opaco, ottone o nero opaco.

Metal decentralizer with hook and dowel fitting for 2x0.75mm cables. Finishes: Matt white; brass or matt black.



GSOBL10 Bianco Opaco / White Matt

GSOBL11 Nero Opaco / Black Matt

GSOBL12 Ottone / Brass

Pack: **0,00019 m³**



Decentratore in metallo con regolazione per cavi elettrici.

Metal decentralizations with adjustment for electric cables.



GSOBL01 Bianco Opaco / White Matt

GSOBL02 Nero Opaco / Black Matt

GSOBL03 Ottone / Brass

Pack: **0,00002 m³**



FINISHING

 Bianco Opaco / Matt White

 Nero Opaco / Matt Black

 Ottone / Brass

A L I C E

**La tradizione del Balloton messa in risalto
da finiture ricercate**

**The Balloton tradition enhanced
with a refined finish**









ALICE

Sospensioni con montatura in metallo. Finiture: Bianco opaco; Ottone; Nero opaco. Vetro con decorazione a sfumare trasparente.

Finiture: Bianco; Ambra; Grigio fumè. Lampadine non incluse.

N.B. La montatura piccola (ALICE M S/P) è da abbinare al vetro piccolo (ALICE V/P). La montatura grande (ALICE M S/G) è da abbinare al vetro grande (ALICE V/G).

Suspension with metal frame. Glass with faded and transparent decorations. Available finishes: white; amber; smoky grey. Bulbs not included.

N.B. The small frame (Alice M S/P) is to be combined with the small glass (Alice V/P).

The large frame (Alice M S/G) is to be combined with the large glass (Alice V/G).



ALICE V/P

Pack: **0,0279 m³**



ALICE M S/P

Socket: **1xE27**
Power: **max 60W**
input: **220/240V**
Pack: **0,0037 m³**

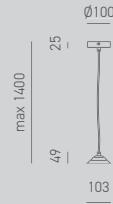

ALICE V/G

Pack: **0,088 m³**

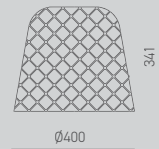

ALICE M S/G

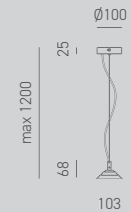

Socket: **1xE27**
Power: **max 60W**
input: **220/240V**
Pack: **0,0037 m³**



FINISHING

-  Ottone / Brass
-  Nero Opaco / Matt Black
-  Bianco Opaco / Matt White

GLASSES

-  Ambra / Amber
-  Fumè / Smoked
-  Bianco / White

Nessuna montatura è abbinata ai vetri, sono a libera scelta

No frame is combined with the glasses, they can be chosen freely.

ALICE KIT



La creatività che si esprime attraverso la luce
Creativity expressed through light











IL SISTEMA MODULARE È UN MODO DI FARE ILLUMINAZIONE SEMPRE PIÙ APPREZZATO. PERMETTE INFATTI DI INSTALLARE A SOFFITTO PIÙ PUNTI LUCE CON LA POSSIBILITÀ DI CREARE COMPOSIZIONI SIMMETRICHE O ASIMMETRICHE, QUESTE ULTIME PERMETTONO ANCHE DI SPOSTARE E DECENTRARE

THE MODULAR SYSTEM IS AN INCREASINGLY POPULAR WAY OF ILLUMINATING A SPACE, AS YOU CAN INSTALL MULTIPLE LIGHT POINTS ON THE CEILING IN SYMMETRICAL OR ASYMMETRICAL COMPOSITIONS. WITH ASYMMETRICAL COMPOSITIONS, THE LIGHT CAN BE MOVED AND DECENTRALISED FOR A TRULY BESPOKE FINISH.





ALICE KIT

Vetro con decorazione a sfumare trasparente.
Finiture: Bianco; Ambra; Grigio fumè.

Glass with faded and transparent effects.
Available finishes: white; amber; smoky grey.



ALICE V/P

Pack: **0,0279 m³**



ESEMPIO ORDINE ESEMPIO ORDINE

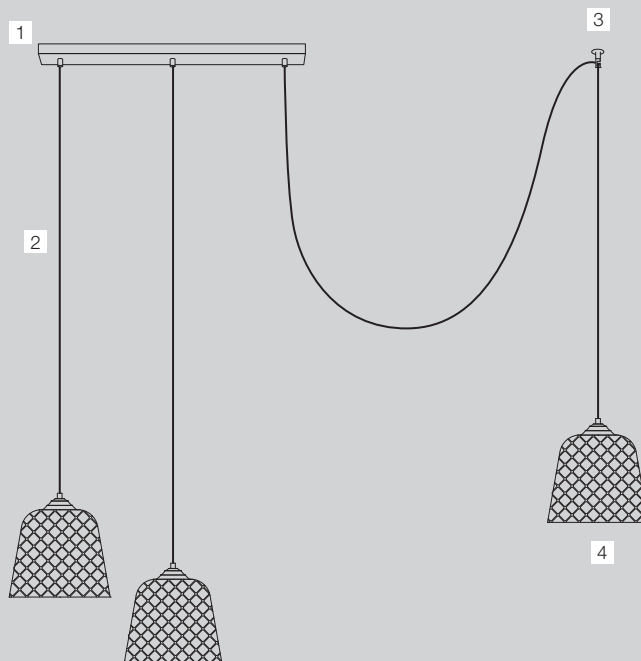

1 ALICE B R/3
x 1 pz.

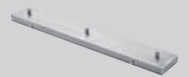

2 ALICE M SR/P
x 3 pz.





3 GSOBL12
x 1 pz.



4 ALICE V/P
x 3 pz.



GLASSES

-  Bianco / White
-  Ambra / Amber
-  Fumè / Smoked

ALICE KIT

Montatura in metallo senza rosone dotata di cavo elettrico di lunghezza 3 metri. Lampadina non inclusa. Finitura: Bianco opaco, ottone o nero opaco.

Metal frame without canopy equipped with 3 meter long electric cable. Bulb not included.

Finishes: Matt white; brass or matt black.



ALICE M SR/P

Socket: **1xE27**
Power: **max 60W**
input: **220/240V**
Pack: **0,0025 m³**

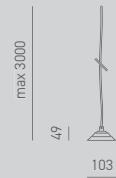

Rosone rettangolare a tre fori in metallo con staffa ed accessori per il fissaggio inclusi. Inclusi tre pressacavi e morsettiera elettrica. Finiture: Bianco opaco, ottone o nero opaco.

Three-hole, rectangular metal ceiling rose with bracket and fixing accessories included. Includes three cable glands and electrical terminal block.

Finishes: Matt white; brass or matt black.

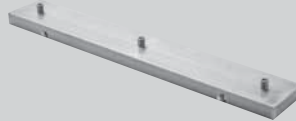

ALICE B R/3

Pack: **0,0059 m³**

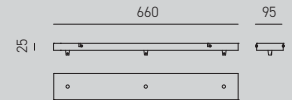

Rosone a tre fori in metallo con staffa ed accessori per il fissaggio inclusi. Inclusi tre pressacavi e morsettiera elettrica. Finiture: Bianco opaco, ottone o nero opaco.

Three-hole metal ceiling rose with bracket and fixing accessories included. Includes three cable glands and electrical terminal block.

Finishes: Matt white; brass or matt black.



ALICE B T/3

Pack: **0,0092 m³**

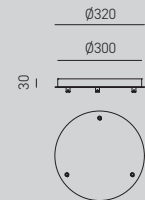

Rosone a sei fori in metallo con staffa ed accessori per il fissaggio inclusi. Inclusi tre pressacavi e morsettiera elettrica. Finiture: Bianco opaco, ottone o nero opaco.

Six-hole metal ceiling rose with bracket and fixing accessories included. Includes six cable glands and electrical terminal block.

Finishes: Matt white; brass or matt black.



ALICE B T/6

Pack: **0,027 m³**

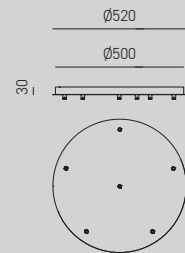

Decentratore in metallo con aggancio e fissaggio con grano per cavi 2x0,75mm. Finiture: Bianco opaco, ottone o nero opaco.

Metal decentralizer with hook and dowel fitting for 2x0.75mm cables.

Finishes: Matt white, brass or matt black.



GSOBL10 Bianco Opaco / White Matt
GSOBL11 Nero Opaco / Black Matt
GSOBL12 Ottone / Brass
Pack: **0,00019 m³**



Decentratore in metallo con regolazione per cavi elettrici.

Metal decentralizations with adjustment for electric cables.



GSOBL01 Bianco Opaco / White Matt
GSOBL02 Nero Opaco / Black Matt
GSOBL03 Ottone / Brass
Pack: **0,00002 m³**



FINISHING

-  Bianco Opaco / Matt White
-  Nero Opaco / Matt Black
-  Ottone / Brass

CLEOFE



Una raffinata texture per creare eleganti atmosfere
A refined texture that creates elegant atmospheres















UNA VERA CASCATA
DI LUCI E FORME
DIFFERENTI
ACCOMUNATE DA
UNA PARTICOLARE
LAVORAZIONE
ARTISTICA DEL VETRO
CON LA DECORAZIO IN
RILIEVO SVILUPPATA A
SPINA DI PESCE.

A TRUE CASCADE OF
VARYING LIGHTS AND
SHAPES UNITED BY
A SPECIAL ARTISTIC
PROCESSING
TECHNIQUE, WHERE THE
GLASS IS DECORATED
WITH A HERRINGBONE
PATTERN IN RELIEF.

CLEOFE

Sospensioni con montatura in metallo.
 Finiture: Metallo bianco opaco con vetro bianco opale; Metallo nero opaco con vetro cobalto trasparente; Metallo ottone con vetro ambra trasparente; Metallo cromo con vetro ocra trasparente. Lampadine non incluse.

Suspension lighting with metal frame.
 Finishes: Matt white metal with opal white glass; Matt black metal with transparent cobalt glass; Brass metal with transparent amber glass; Chrome metal with transparent ochre glass. Bulbs not included.



CLEOFE S/10

Socket: **1xE27**
 Power: **max 60W**
 Input: **220/240V**
 Pack: **0,035 m³**

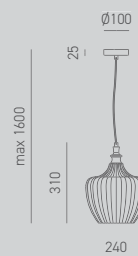

CLEOFE S/11

Socket: **1xE27**
 Power: **max 60W**
 Input: **220/240V**
 Pack: **0,028 m³**

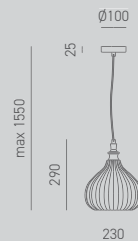

CLEOFE S/12

Socket: **1xE27**
 Power: **max 60W**
 Input: **220/240V**
 Pack: **0,025 m³**

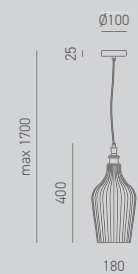

FINISHING

-  Bianco Opaco / Matt White
-  Nero Opaco / Matt Black
-  Ottone / Brass
-  Cromo / Chrome

GLASSES

-  Bianco Opale / Opal White
-  Cobalto / Cobalt
-  Ambra Trasparente / Transparent Amber
-  Ocra / Ochre

CLEOFE

Sospensioni con montatura in metallo.
Finiture: Metallo bianco opaco con vetri bianco opale; Metallo ottone con vetri ambra trasparente; Metallo nero opaco con 1 vetro ambra trasparente, 1 vetro ocra ed 1 vetro cobalto. Le combinazioni di vetri e montature sono quelle illustrate e non sono modificabili. Lampadine non incluse.

Suspension lighting with metal frame.
Finishes: Matt white metal with opal white glass; Brass metal with transparent amber glasses; Matt black metal with 1 transparent amber glass, 1 ochre glass and 1 cobalt glass. The combinations of glasses and frames are those shown and cannot be changed.



CLEOFE S/3



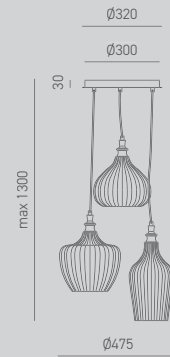

Socket: **3xE27**
Power: **max 3x60W**
Input: **220/240V**
Pack: **0,142 m³**



FINISHING

-  Bianco Opaco / White Matt
-  Ottone / Brass
-  Nero Opaco / Black Matt

GLASSES

-  Bianco Opale / Opal White
-  Ambra Trasparente / Transparent Amber
-  Ocra / Ochre
-  Cobalto / Cobalt
-  Ambra Trasparente / Transparent Amber

Sospensioni con montatura in metallo.
Finiture: Metallo bianco opaco con vetri bianco opale; Metallo nero opaco con 2 vetri ambra trasparente, 2 vetri ocra e 2 vetri cobalto. Le combinazioni di vetri e montature sono quelle illustrate e non sono modificabili. Lampadine non incluse.

Suspension lighting with metal frame.
Finishes: Matt white metal with opal white glass; Matt black metal with transparent amber glass x 2, ochre glass x 2 and cobalt glass x 2. The combinations of glasses and frames are those shown and cannot be changed. Bulbs not included.





CLEOFE S/6

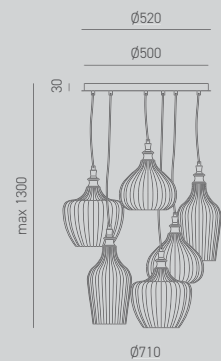



Socket: **6xE27**
Power: **max 6x60W**
Input: **220/240V**
Pack: **0,251 m³**



FINISHING

-  Bianco Opaco / Matt White
-  Nero Opaco / Matt Black

GLASSES

-  Bianco Opale / Opal White
-  Ocra / Ochre
-  Cobalto / Cobalt
-  Ambra Trasparente / Transparent Amber

FILLY



Solo essenziale che arreda è visibile agli occhi
Only the essential design features are visible
to the eyes







FILLY KIT

Sospensioni senza rosoni dotati di cavo elettrico rivestito in tessuto 3m, sezione 2x0,75mm. Portalampane E27. Lampadina non inclusa.

Finiture: Bianco satinato con cavo in tessuto bianco; Nero satinato con cavo in tessuto nero; Ottone con cavo in tessuto oro; Rame con cavo in tessuto marrone; Nickel satinato con cavo in tessuto grigio; Grigio cemento con cavo in tessuto grigio

Pendant lights without canopy equipped with a fabric sheathed, 3m electric cable, 2x0.75mm section. Lampholder E27. Bulb not included. Available finishes: satin white with white fabric cable; satin black with black fabric cable; brass with gold fabric cable; copper with brown fabric cable; satin nickel with grey fabric cable; concrete grey with grey fabric cable.



GSOS01 Bianco Satinato/Sand White

GSOS02 Nero Satinato/Sand Black

GSOS03 Ottone/Brass

GSOS04 Rame/Copper

GSOS05 Nickel Satinato/Satin Nickel

GSOS06 Grigio Cemento/Concrete Grey

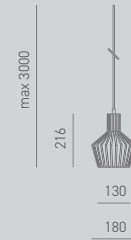

Socket: **1xE27**

Power: **max 40W**

input: **220/240V**

IP: **20**

Pack: **0,0086 m³**

GSOB40

Rosone rettangolare a tre fori in metallo con staffa ed accessori per il fissaggio inclusi.

Inclusi tre pressacavi e morsettiere elettrica.

Finiture: Bianco satinato; Nero satinato;

Ottone; Rame; Nickel satinato; Grigio cemento

Three-hole, rectangular metal ceiling rose with bracket and fixing accessories included. Includes three cable glands and electrical terminal block. Finishes: Matt white; Matt black; Brass; Copper; Matt nickel; Slate grey.



GSOB40 Bianco Satinato/Sand White

GSOB41 Nero Satinato/Sand Black

GSOB42 Ottone/Brass

GSOB43 Rame/Copper

GSOB44 Nickel Satinato/Satin Nickel

GSOB45 Grigio Cemento/Concrete Grey

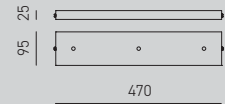

GSOB20

Rosone rettangolare a cinque fori in metallo con staffa ed accessori per il fissaggio inclusi.

Inclusi cinque pressacavi e morsettiere elettrica.

Finiture: Bianco satinato; Nero satinato; Ottone;

Rame; Nickel satinato; Grigio cemento

Five-hole, rectangular metal ceiling rose with bracket and fixing accessories included. Includes five cable glands and electrical terminal block. Finishes: Matt white; Matt black; Brass; Copper; Matt nickel; Slate grey.

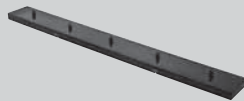

GSOB20 Bianco Satinato/Sand White

GSOB21 Nero Satinato/Sand Black

GSOB22 Ottone/Brass

GSOB23 Rame/Copper





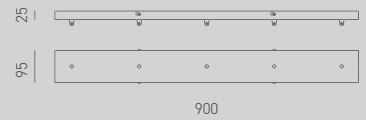

GSOB24 Nickel Satinato/Satin Nickel

GSOB25 Grigio Cemento/Concrete Grey



ESEMPIO ORDINE ESEMPIO ORDINE

FINISHING

-  Bianco Satinato / Satin White
-  Nero Satinato / Satin Black
-  Ottone / Brass
-  Rame / Copper
-  Nickel Satinato / Satin Nickel
-  Grigio Cemento / Concrete Grey

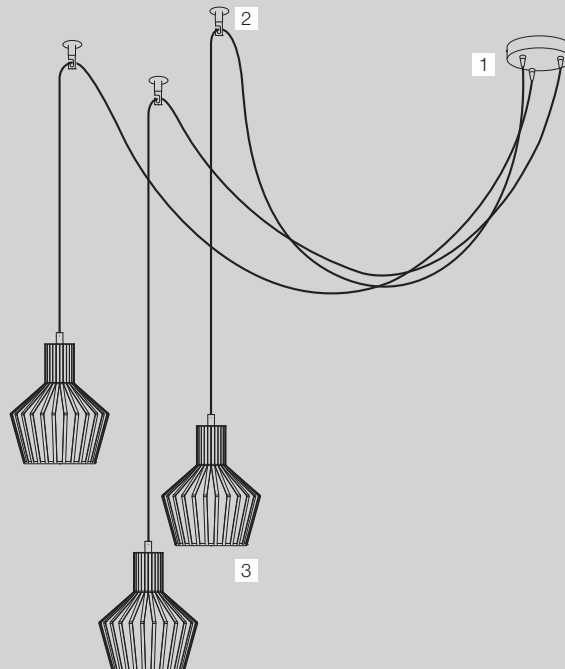

1 **GSOB31**
x 1 pz.



2 **GSOBL11**
x 3 pz.



3 **GSOS01**
x 3 pz.



FILLY KIT

Rosone ad un foro in metallo con staffa ed accessori per il fissaggio inclusi. Incluso un pressacavo e morsettiere elettrica.
Finiture: Bianco satinato; Nero satinato; Ottone; Rame; Nickel satinato; Grigio cemento.

One-hole metal ceiling rose with bracket and fixing accessories included. Includes a cable gland and electrical terminal block. Finishes: Matt white; Matt black; Brass; Copper; Matt nickel; Slate grey.



GSOB10 Bianco Satinato/Sand White
GSOB11 Nero Satinato/Sand Black
GSOB12 Ottone/Brass
GSOB13 Rame/Copper
GSOB14 Nickel Satinato/Satin Nickel
GSOB15 Grigio Cemento/Concrete Grey



Rosone a tre fori in metallo con staffa ed accessori per il fissaggio inclusi. Inclusi tre pressacavi e morsettiere elettrica.
Finiture: Bianco satinato; Nero satinato; Ottone; Rame; Nickel satinato; Grigio cemento.

Three-hole metal ceiling rose with bracket and fixing accessories included. Includes three cable glands and electrical terminal block. Finishes: Matt white; Matt black; Brass; Copper; Matt nickel; Slate grey.



GSOB30 Bianco Satinato/Sand White
GSOB31 Nero Satinato/Sand Black
GSOB32 Ottone/Brass
GSOB33 Rame/Copper
GSOB34 Nickel Satinato/Satin Nickel
GSOB35 Grigio Cemento/Concrete Grey

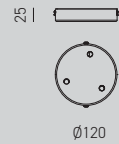

Rosone a cinque fori in metallo con staffa ed accessori per il fissaggio inclusi. Inclusi cinque pressacavi e morsettiere elettrica.
Finiture: Bianco satinato; Nero satinato; Ottone; Rame; Nickel satinato; Grigio cemento.

Five-hole metal ceiling rose with bracket and fixing accessories included. Includes five cable glands and electrical terminal block. Finishes: Matt white; Matt black; Brass; Copper; Matt nickel; Slate grey.



GSOB50 Bianco Satinato/Sand White
GSOB51 Nero Satinato/Sand Black
GSOB52 Ottone/Brass
GSOB53 Rame/Copper
GSOB54 Nickel Satinato/Satin Nickel
GSOB55 Grigio Cemento/Concrete Grey

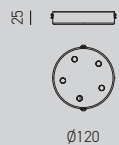

Rosone a dodici fori laterali in metallo con staffa ed accessori per il fissaggio inclusi. Inclusi dodici pressacavi e morsettiere elettriche.
Finiture: Bianco satinato; Nero satinato; Ottone; Rame; Nickel satinato; Grigio cemento.

Metal ceiling rose with twelve lateral holes, includes bracket and fixing accessories. Twelve cable glands and electrical terminal blocks included. Finishes: Matt white; Matt black; Brass; Copper; Matt nickel; Slate grey.



GSOB01 Bianco Satinato/Sand White
GSOB02 Nero Satinato/Sand Black
GSOB03 Ottone/Brass
GSOB04 Rame/Copper
GSOB05 Nickel Satinato/Satin Nickel
GSOB06 Grigio Cemento/Concrete Grey

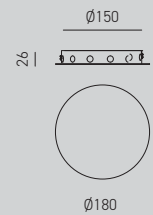

Decentratore in metallo con aggancio e fissaggio con grano per cavi in stoffa 2x0,75mm.
Finiture: Bianco satinato; Nero satinato; Ottone; Rame; Nickel satinato; Grigio cemento.

Metal decentralizer with hook and dowel fitting for 2x0.75mm fabric cables. Finishes: Matt white; Matt black; Brass; Copper; Matt nickel; Slate grey.



GSOBL10 Bianco Satinato/Sand White
GSOBL11 Nero Satinato/Sand Black
GSOBL12 Ottone/Brass
GSOBL13 Rame/Copper
GSOBL14 Nickel Satinato/Satin Nickel
GSOBL15 Grigio Cemento/Concrete Grey



Decentratore in metallo con regolazione per cavi in stoffa 2x0,75mm.
Finiture: Bianco satinato; Nero satinato; Ottone; Rame; Nickel satinato; Grigio cemento.

Metal decentraliser with adjustment for 2x0.75mm fabric cables. Finishes: Matt white; Matt black; Brass; Copper; Matt nickel; Slate grey.



GSOBL01 Bianco Satinato/Sand White
GSOBL02 Nero Satinato/Sand Black
GSOBL03 Ottone/Brass
GSOBL04 Rame/Copper
GSOBL05 Nickel Satinato/Satin Nickel
GSOBL06 Grigio Cemento/Concrete Grey



FLASH FLIP FLUTE



La luce industrial dal sapore retro chic
Retro-chic industrial lighting





FLASH FLIP FLUTE

Pendente assemblato con cavo in stoffa 2m, sezione 2x0,75mm. Portalampane E27. Incluso di rosone ed accessori per il fissaggio a sospensione. Lampadina non inclusa. Disponibile nei seguenti colori: Bianco satinato con cavo in stoffa bianco; Nero satinato con cavo in stoffa nero; Ottone con cavo in stoffa oro; Rame con cavo in stoffa marrone; Nickel satinato con cavo in stoffa grigio; Grigio cemento con cavo in stoffa grigio.

Pendant mounted with 2m fabric cable, 2x0.75mm section. Lampholder E27. Includes rose and accessories for suspension fitting. Bulb not included. Available in the following colours: Matt white with white fabric cable; Matt black with black fabric cable; Brass with gold fabric cable; Copper with brown fabric cable; Matt nickel with grey fabric cable; Slate grey with grey fabric cable.

FLUTE



- GS0070** Bianco Satinato/Sand White
- GS0071** Nero Satinato/Sand Black
- GS0072** Ottone/Brass
- GS0073** Rame/Copper
- GS0074** Nickel Satinato/Satin Nickel
- GS0075** Grigio Cemento/Concrete Grey

Socket: **1xE27**
 Power: **max 40W**
 input: **220/240V**
 IP: **20**
 Pack: **0,0010 m³**

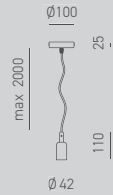

FLIP



- GS0080** Bianco Satinato/Sand White
- GS0081** Nero Satinato/Sand Black
- GS0082** Ottone/Brass
- GS0083** Rame/Copper
- GS0084** Nickel Satinato/Satin Nickel
- GS0085** Grigio Cemento/Concrete Grey

Socket: **1xE27**
 Power: **max 40W**
 input: **220/240V**
 IP: **20**
 Pack: **0,0010 m³**

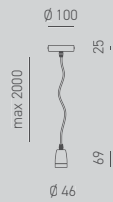

FLASH







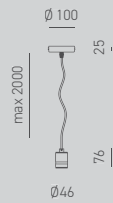

- GS0090** Bianco Satinato/Sand White
- GS0091** Nero Satinato/Sand Black
- GS0092** Ottone/Brass
- GS0093** Rame/Copper
- GS0094** Nickel Satinato/Satin Nickel
- GS0095** Grigio Cemento/Concrete Grey

Socket: **1xE27**
 Power: **max 40W**
 input: **220/240V**
 IP: **20**
 Pack: **0,0010 m³**



FINISHING

-  Bianco Satinato / Satin White
-  Nero Satinato / Satin Black
-  Ottone / Brass
-  Rame / Copper
-  Nickel Satinato / Satin Nickel
-  Grigio Cemento / Concrete Grey

FLASH FLIP FLUTE



**La creatività appesa ad un filo
per composizioni costum**
Creativity hanging by a wire,
for custom compositions













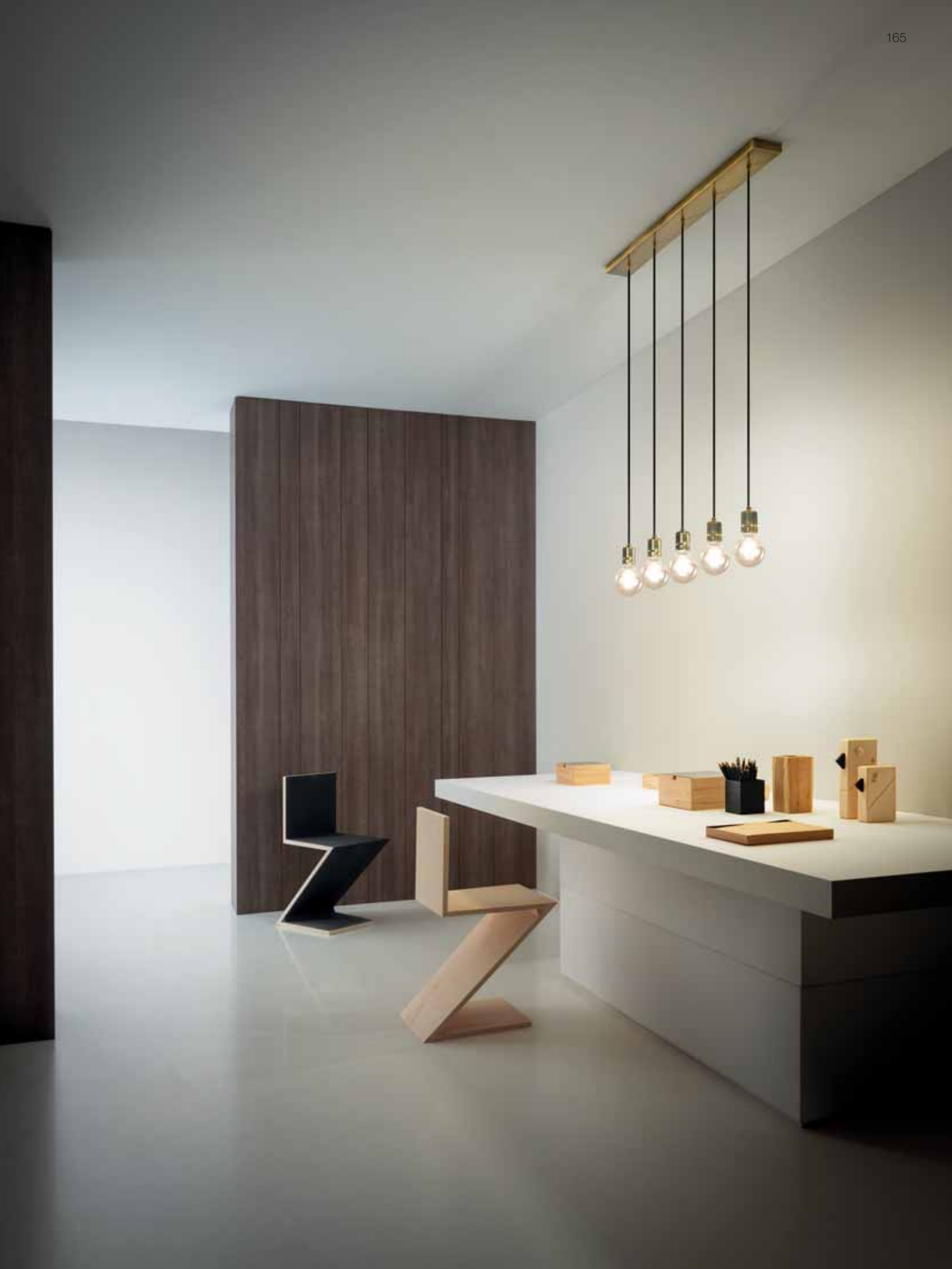

FLASH FLIP FLUTE KIT

PORTALAMPADE / LAMPHOLDER

Portalampe in metallo con pressacavo incluso. Finiture: Bianco satinato; Nero satinato; Ottone; Rame; Nickel satinato; Grigio cemento.

Metal lamp holder with cable gland included.

Finishes: satin white; satin black; brass; copper; satin nickel; concrete grey.



GSOP70 Bianco Satinato/Sand White
GSOP71 Nero Satinato/Sand Black
GSOP72 Ottone/Brass
GSOP73 Rame/Copper
GSOP74 Nickel Satinato/Satin Nickel
GSOP75 Grigio Cemento/Concrete Grey

Socket: **1xE27**

Power: **max 40W**

input: **220/240V**

IP: **20**

Pack: **0,00034 m³**



GSOP80 Bianco Satinato/Sand White
GSOP81 Nero Satinato/Sand Black
GSOP82 Ottone/Brass
GSOP83 Rame/Copper
GSOP84 Nickel Satinato/Satin Nickel
GSOP85 Grigio Cemento/Concrete Grey

Socket: **1xE27**

Power: **max 40W**

input: **220/240V**

IP: **20**

Pack: **0,0034 m³**



GSOP90 Bianco Satinato/Sand White
GSOP91 Nero Satinato/Sand Black
GSOP92 Ottone/Brass
GSOP93 Rame/Copper
GSOP94 Nickel Satinato/Satin Nickel
GSOP95 Grigio Cemento/Concrete Grey

Socket: **1xE27**

Power: **max 40W**

input: **220/240V**

IP: **20**

Pack: **0,0034 m³**



ROSONI RETTANGOLARI /

RECTANGULAR CEILING ROSE

Rosone rettangolare a 3 o 5 fori in metallo con staffa ed accessori per il fissaggio inclusi. Inclusi 3 o 5 pressacavi e morsettiera elettrica.

Finiture: Bianco satinato; Nero satinato; Ottone; Rame; Nickel satinato; Grigio cemento.

3 or 5 holes, rectangular metal ceiling rose with bracket and fixing accessories included.

Includes 3 or 5 cable glands and electrical terminal block.

Finishes: Matt white; Matt black; Brass; Copper; Matt nickel; Slate grey.



GSOB40 Bianco Satinato/Sand White
GSOB41 Nero Satinato/Sand Black
GSOB42 Ottone/Brass
GSOB43 Rame/Copper
GSOB44 Nickel Satinato/Satin Nickel
GSOB45 Grigio Cemento/Concrete Grey

Pack: **0,00138 m³**

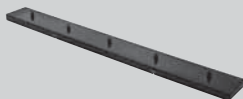
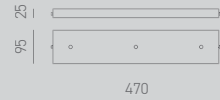

GSOB20 Bianco Satinato/Sand White
GSOB21 Nero Satinato/Sand Black
GSOB22 Ottone/Brass
GSOB23 Rame/Copper
GSOB24 Nickel Satinato/Satin Nickel
GSOB25 Grigio Cemento/Concrete Grey

Pack: **0,00299 m³**

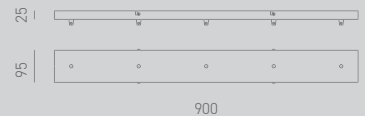

FLASH FLIP FLUTE KIT

Rosone ad 1, 3, 5, 12 fori in metallo con staffa ed accessori per il fissaggio inclusi. Completo di pressacavi e morsettiera elettrica.

Finiture: Bianco satinato; Nero satinato; Ottone; Rame; Nickel satinato; Grigio cemento.

1, 3, 5, 12 hole metal ceiling rose with bracket and fixing accessories included.

Includes a cable gland and electrical terminal block. Finishes: Matt white; Matt black; Brass; Copper; Matt nickel; Slate grey.



GSOB10 Bianco Satinato/Sand White
GSOB11 Nero Satinato/Sand Black
GSOB12 Ottone/Brass
GSOB13 Rame/Copper
GSOB14 Nickel Satinato/Satin Nickel
GSOB15 Grigio Cemento/Concrete Grey
 Pack: **0,00039 m³**



GSOB30 Bianco Satinato/Sand White
GSOB31 Nero Satinato/Sand Black
GSOB32 Ottone/Brass
GSOB33 Rame/Copper
GSOB34 Nickel Satinato/Satin Nickel
GSOB35 Grigio Cemento/Concrete Grey
 Pack: **0,00047 m³**

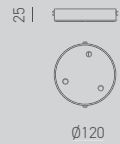

GSOB50 Bianco Satinato/Sand White
GSOB51 Nero Satinato/Sand Black
GSOB52 Ottone/Brass
GSOB53 Rame/Copper
GSOB54 Nickel Satinato/Satin Nickel
GSOB55 Grigio Cemento/Concrete Grey
 Pack: **0,00047 m³**

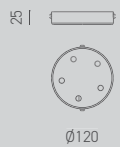

GSOB01 Bianco Satinato/Sand White
GSOB02 Nero Satinato/Sand Black
GSOB03 Ottone/Brass
GSOB04 Rame/Copper
GSOB05 Nickel Satinato/Satin Nickel
GSOB06 Grigio Cemento/Concrete Grey
 Pack: **0,00103 m³**

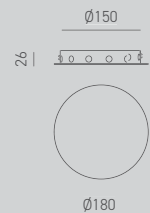

Decentratore in metallo con aggancio e fissaggio con grano per cavi in stoffa 2x0,75mm. Finiture: Bianco satinato; Nero satinato; Ottone; Rame; Nickel satinato; Grigio cemento.

Metal decentralizer with hook and dowel fitting for 2x0.75mm fabric cables. Finishes: Matt white; Matt black; Brass; Copper; Matt nickel; Slate grey.



GSOBL10 Bianco Satinato/Sand White
GSOBL11 Nero Satinato/Sand Black
GSOBL12 Ottone/Brass
GSOBL13 Rame/Copper
GSOBL14 Nickel Satinato/Satin Nickel
GSOBL15 Grigio Cemento/Concrete Grey
 Pack: **0,00019 m³**



Decentratore in metallo con regolazione per cavi in stoffa 2x0,75mm. Finiture: Bianco satinato; Nero satinato; Ottone; Rame; Nickel satinato; Grigio cemento.

Metal decentraliser with adjustment for 2x0.75mm fabric cables. Finishes: Matt white; Matt black; Brass; Copper; Matt nickel; Slate grey.



GSOBL01 Bianco Satinato/Sand White
GSOBL02 Nero Satinato/Sand Black
GSOBL03 Ottone/Brass
GSOBL04 Rame/Copper
GSOBL05 Nickel Satinato/Satin Nickel
GSOBL06 Grigio Cemento/Concrete Grey
 Pack: **0,00002 m³**



FLASH FLIP FLUTE KIT

ESEMPIO ORDINE
ESEMPIO ORDINE

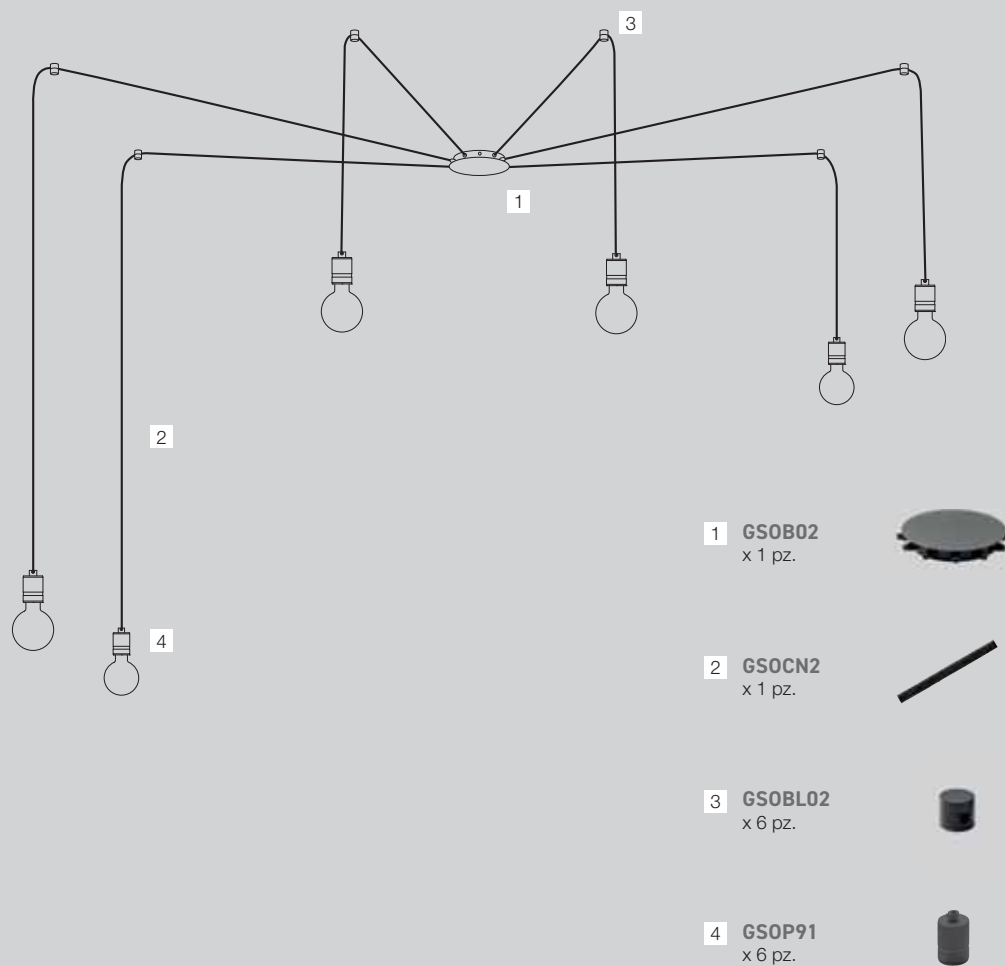

FLASH FLIP FLUTE KIT

Cavo elettrico rivestito in tessuto di sezione 2x0,75mm. Disponibili in bobine da 20 o 50 metri dei seguenti colori: blu, grigio, marrone, nero, oro, rosso, argento, verde, bianco.

Electric cable covered in fabric with 2x0,75mm section. Available in 20 or 50 metre reels in the following colors: blue, grey, brown black, gold, red, silver, green, white.

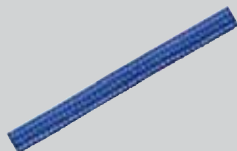

GSOCB2

Meters: **20**
Finished: **Blu/Blue**

GSOCB5

Meters: **50**
Finished: **Blu/Blue**

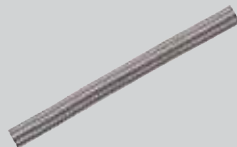

GSOCG2

Meters: **20**
Finished: **Grigio/Grey**

GSOCG5

Meters: **50**
Finished: **Grigio/Grey**



GSOCM2

Meters: **20**
Finished: **Marrone/Brown**

GSOCM5

Meters: **50**
Finished: **Marrone/Brown**



GSOCN2

Meters: **20**
Finished: **Nero/Black**

GSOCN5

Meters: **50**
Finished: **Nero/Black**



GSOC02

Meters: **20**
Finished: **Oro/Gold**

GSOC05

Meters: **50**
Finished: **Oro/Gold**



GSOCR2

Meters: **20**
Finished: **Rosso/Red**

GSOCR5

Meters: **50**
Finished: **Rosso/Red**

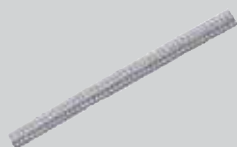

GSOCS2

Meters: **20**
Finished: **Argento/Silver**

GSOCS5

Meters: **50**
Finished: **Argento/Silver**

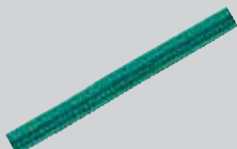

GSOCV2

Meters: **20**
Finished: **Verde/Green**

GSOCV5

Meters: **50**
Finished: **Verde/Green**



GSOCW2

Meters: **20**
Finished: **Bianco/White**

GSOCW5

Meters: **50**
Finished: **Bianco/White**

SFERA



**Metafisica e design si incontrano
nella perfezione della sfera**
The perfect sphere: where metaphysics
meets design









SFERA

Sospensione con montatura in metallo satinato bianco. Diffusore in vetro opale agganciato ad una sfera di cemento con finitura grigio chiaro, grigio scuro o rosso. Lampadina non inclusa. Misura massima della lampadina diam. 19 mm, h 61 mm.

Suspension with satin white metal frame. Opal glass diffuser attached to a concrete sphere with light grey, dark grey or red finish. Bulb not included. Maximum bulb size 19 mm diameter, 61 mm height.

FINISHING

-  Grigio chiaro / Light grey
-  Grigio scuro / Dark grey
-  Rosso / Red

Sospensione con montatura in metallo satinato bianco. Diffusore in vetro opale agganciato ad una sfera di cemento. Finitura: 2 sfere grigio chiaro, 2 sfere grigio scuro e 2 sfere rosso. Le combinazioni di vetri e montature sono quelle illustrate e non sono modificabili. Misura massima della lampadina diam. 19 mm, h 61 mm. Lampadine non incluse.

Suspension with satin white metal frame. Opal glass diffuser attached to a concrete sphere. Finish: 2 light grey spheres, 2 dark grey spheres and 2 red spheres. The combinations of glasses and frames are those shown and cannot be changed. Maximum bulb size 19 mm diameter, 61 mm height. Bulbs not included.

Sospensione con montatura in metallo satinato bianco. Diffusore in vetro opale agganciato ad una sfera di cemento. Finitura: 3 sfere grigio chiaro, 4 sfere grigio scuro e 3 sfere rosso. Le combinazioni di vetri e montature sono quelle illustrate e non sono modificabili. Misura massima della lampadina diam. 19 mm, h 61 mm. Lampadine non incluse.

Suspension with satin white metal frame. Opal glass diffuser attached to a concrete sphere. Finish: 3 light grey spheres, 4 dark grey spheres and 3 red spheres. The combinations of glasses and frames are those shown and cannot be changed. Maximum bulb size 19 mm diameter, 61 mm height. Bulbs not included.



SFERA S

Socket: **1xG9**
 Power: **max 28W (max 7W led)**
 Input: **220/240V**
 Pack: **0,007 m³**



SFERA S/6

Socket: **6xG9**
 Power: **max 6x28W (max 6x7W led)**
 Input: **220/240V**
 Pack: **0,048 m³**

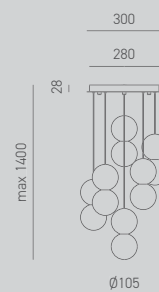

SFERA S/10

Socket: **10xG9**
 Power: **max 10x28W (max 10x7W led)**
 Input: **220/240V**
 Pack: **0,103 m³**

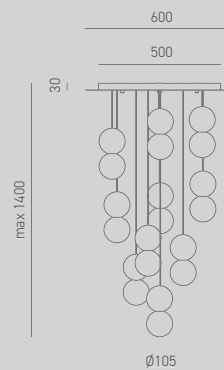

NEW

ERIKA



**Atmosfere soffuse che accolgono
lo sguardo in un abbraccio**
Soft atmospheres with a warm
embracing light

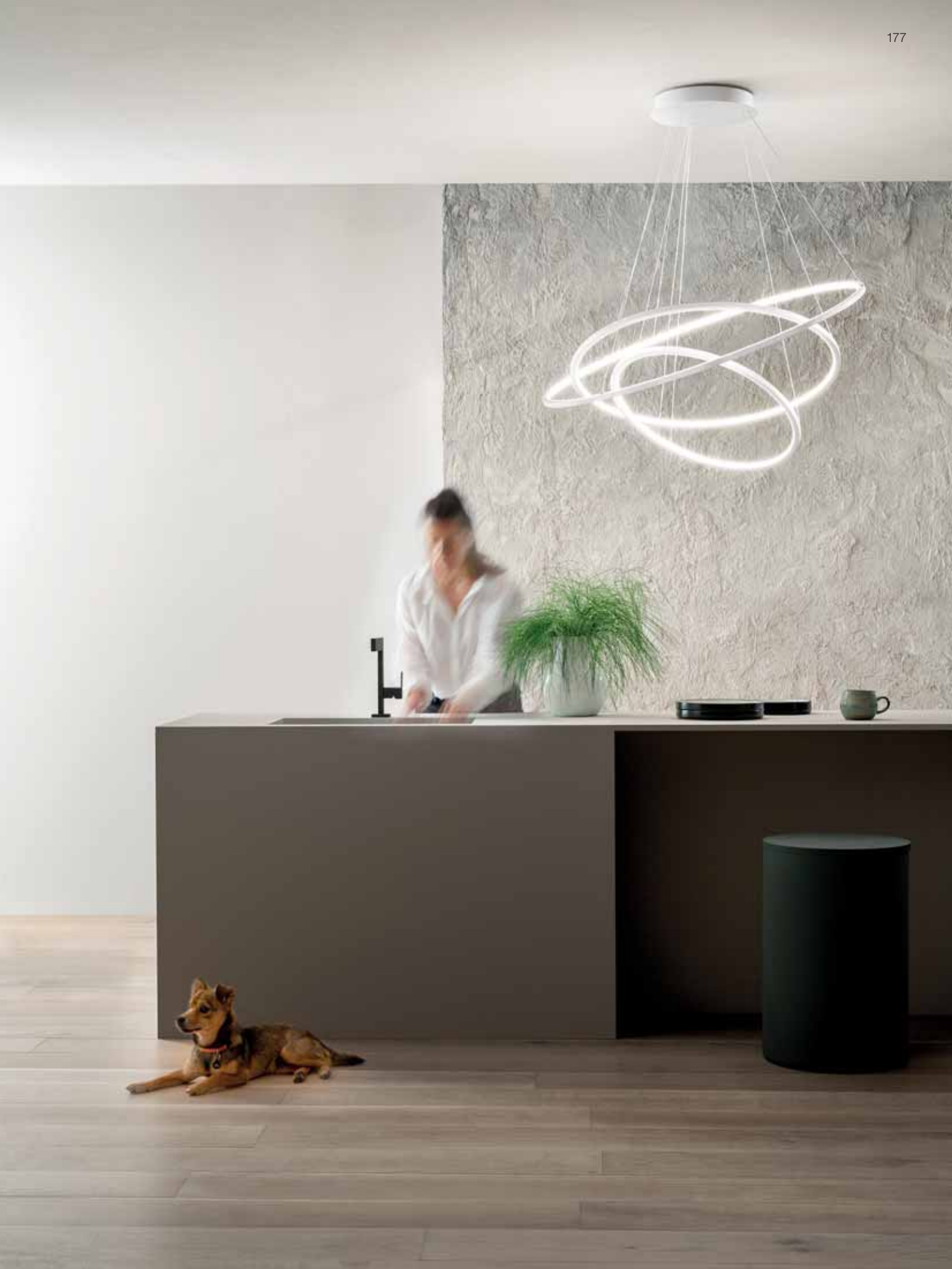

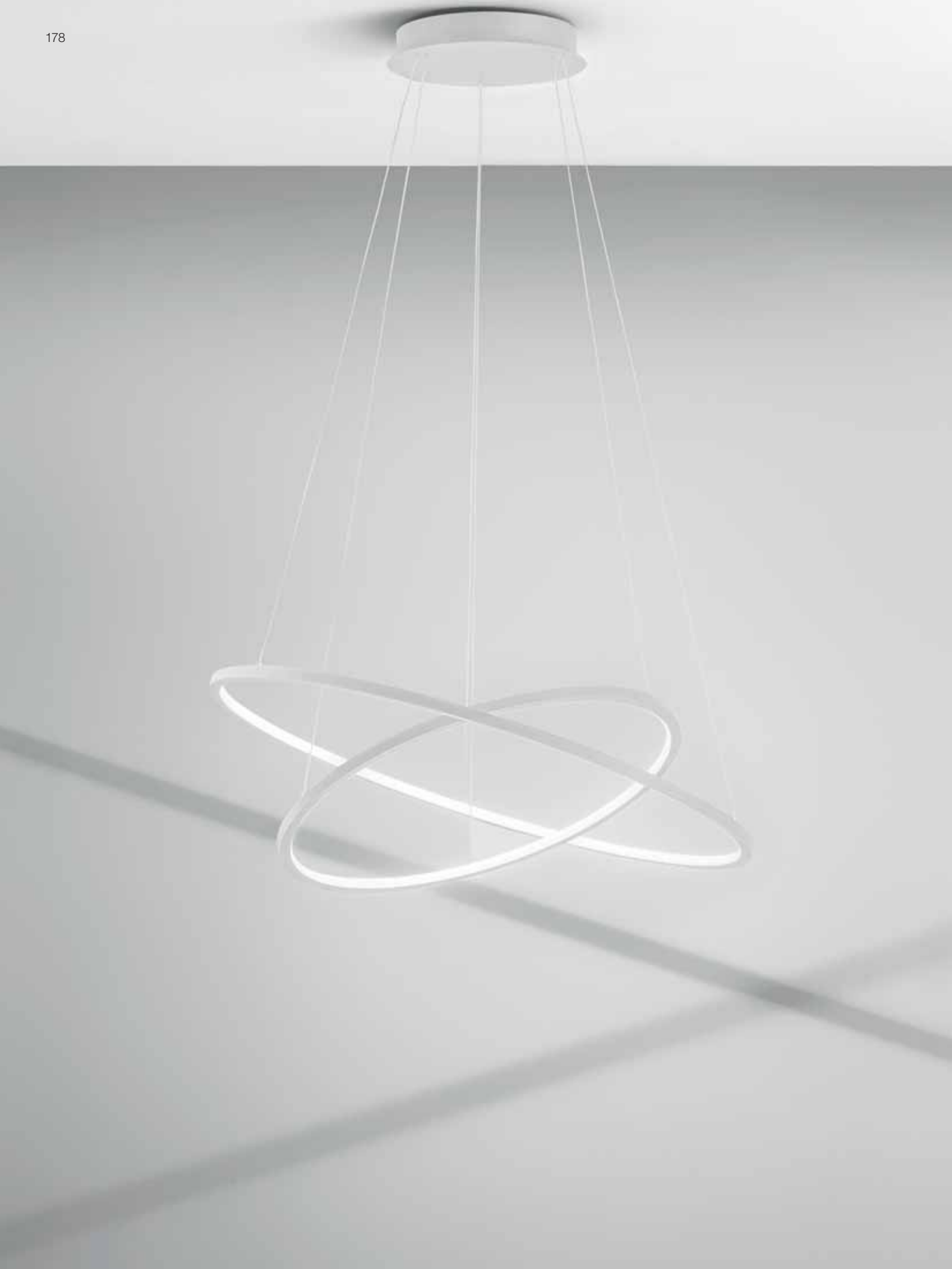







UN SUSSEGUIRSI DI
CIRCONFENZE E
DI ORBITE LUMINOSE
CONFIGURABILI
ALLINEATE O AD ALTEZZE
DIVERSE, DISPONIBILI
NELLE VERSIONI DOPPIA E
TRIPLA SORGENTE.

A SEQUENCE OF
CIRCUMFERENCES
AND LIGHT ORBITS
CONFIGURABLE EITHER
IN-LINE OR AT DIFFERENT
HEIGHTS. AVAILABLE IN
DOUBLE AND TRIPLE-
SOURCE VERSIONS.





ERIKA

Montatura in alluminio satinato bianco.
Diffusore in silicone bianco opale.
Sorgente luminosa led dimmerabile
a taglio di fase tramite dimmer
esterno+push (non inclusi).

White satin-finish aluminium frame.
White opal silicone diffuser. Phase cut
dimmable LED light source via external
dimmer+push (not included).



ERIKA S/P

Socket: **1 modulo LED**
Power: **38W**
input: **220/240V**
Light temp.: **3000°K**
CRI: **>80**
Lumen: **1400Lm**
Pack: **0,035 m³**

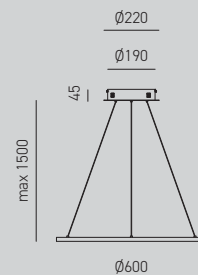

ERIKA S/G

Socket: **1 modulo LED**
Power: **48W**
input: **220/240V**
Light temp.: **3000°K**
CRI: **>80**
Lumen: **1800Lm**
Pack: **0,060 m³**

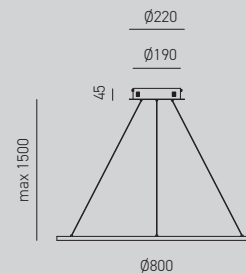

ERIKA S/2

Socket: **2 moduli LED**
Power: **35W+**
45W=80W
input: **220/240V**
Light temp.: **3000°K**
CRI: **>80**
Lumen: **3700Lm**
Pack: **0,060 m³**

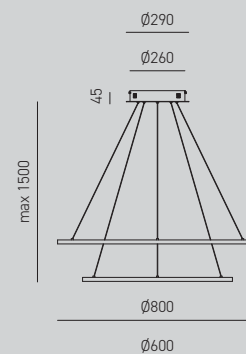

ERIKA S/3

Socket: **3 moduli LED**
Power: **35W+45W+**
48W=128W
input: **220/240V**
Light temp.: **3000°K**
CRI: **>80**
Lumen: **7100Lm**
Pack: **0,090 m³**

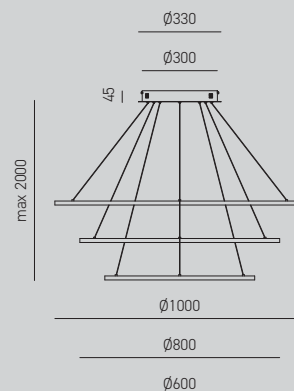

FINISHING



Bianco Satinato - Bianco Satinato
Satin White - Satin White

ERIKA**ERIKA S/2D**

Socket: **2 moduli LED**
 Power: **35W+**
45W=80W
 input: **220/240V**
 Light temp.: **3000°K**
 CRI: **>80**
 Lumen: **3700Lm**
 Pack: **0,060 m³**

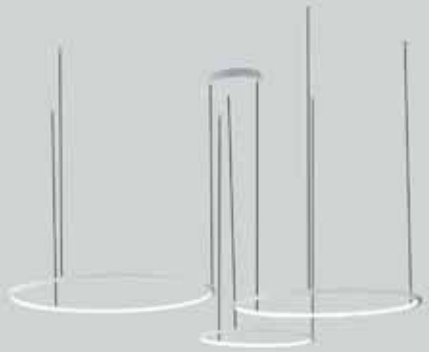
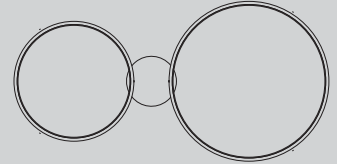
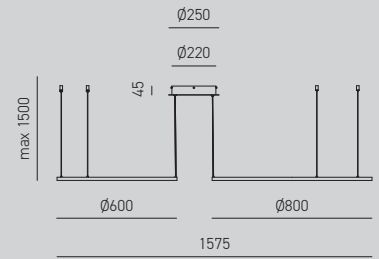
**ERIKA S/3D**

Socket: **3 moduli LED**
 Power: **35W+45W+**
48W=128W
 input: **220/240V**
 Light temp.: **3000°K**
 CRI: **>80**
 Lumen: **7100Lm**
 Pack: **0,090 m³**

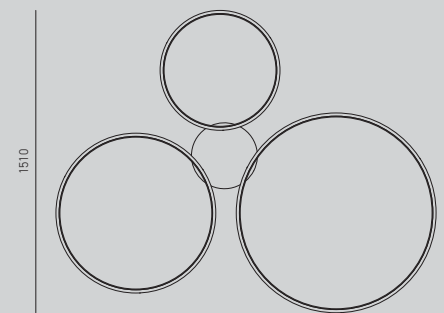
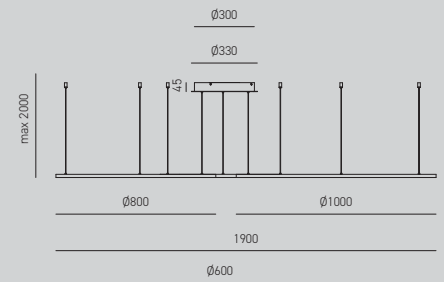

NEW

CRISEIDE



La forma ancestrale del cerchio si veste d'audacia
A bold take on the ancestral circle







CRISEIDE S2 E S3 CON
ROSONE DECENTRATO
CHE PERMETTE DELLE
CONFIGURAZIONI
PERSONALIZZABILI.

CRISEIDE S2 AND S3
WITH DECENTRALISED
CEILING CANOPY
FOR CUSTOM
CONFIGURATIONS.









CRIDEIDE

Montatura in alluminio satinato bianco o oro spazzolato. Diffusore in silicone bianco opale. Sorgente luminosa in biemissione led dimmerabile a taglio di fase tramite dimmer esterno+push (non inclusi).

White satin or brushed gold aluminium frame. White opal silicone diffuser. Dimmable bi-emission LED light source with phase cut via an external dimmer+push (not included).



CRIDEIDE S/P Bianco

Socket: **2 moduli LED**
Power: **60W**
input: **220/240V**
Light temp.: **3000°K**
CRI: **>80**
Lumen: **3200Lm**
Pack: **0,036 m³**

CRIDEIDE S/P Oro

2 moduli LED
60W
220/240V
3000°K
>80
3100Lm
0,036 m³

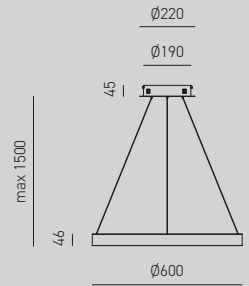

CRIDEIDE S/G Bianco

Socket: **2 moduli LED**
Power: **80W**
input: **220/240V**
Light temp.: **3000°K**
CRI: **>80**
Lumen: **4300Lm**
Pack: **0,061 m³**

CRIDEIDE S/G Oro

2 moduli LED
80W
220/240V
3000°K
>80
4200Lm
0,061 m³

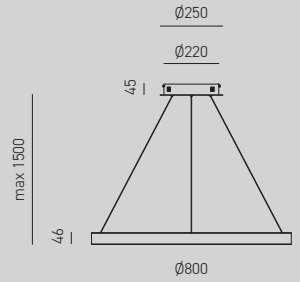

CRIDEIDE S/2P Bianco

Socket: **4 moduli LED**
Power: **40W+**
60W=100W
input: **220/240V**
Light temp.: **3000°K**
CRI: **>80**
Lumen: **5300Lm**
Pack: **0,036 m³**

CRIDEIDE S/2P Oro

4 moduli LED
40W+
60W=100W
220/240V
3000°K
>80
5100Lm
0,036 m³

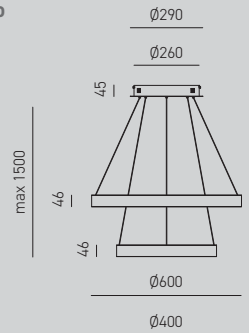

CRIDEIDE S/2G Bianco

Socket: **4 moduli LED**
Power: **60W+**
80W=140W
input: **220/240V**
Light temp.: **3000°K**
CRI: **>80**
Lumen: **7400Lm**
Pack: **0,061 m³**

CRIDEIDE S/2G Oro

4 moduli LED
60W+
80W=140W
220/240V
3000°K
>80
7200Lm
0,061 m³

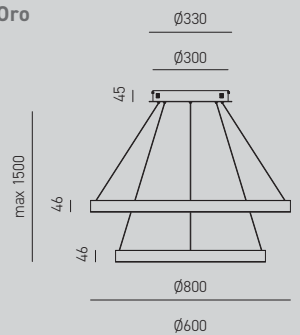

FINISHING

 Bianco Satinato / Satin White

 Oro Spazzolato / Brushed Gold

CRISEIDE

**CRISEIDE S/2D Bianco**

Socket: **4 moduli LED**
 Power: **40W+**
60W=100W
 input: **220/240V**
 Light temp.: **3000°K**
 CRI: **>80**
 Lumen: **5300Lm**
 Pack: **0,036 m³**

CRISEIDE S/2D Oro

Socket: **4 moduli LED**
 Power: **40W+**
60W=100W
 input: **220/240V**
 Light temp.: **3000°K**
 CRI: **>80**
 Lumen: **5100Lm**
 Pack: **0,036 m³**

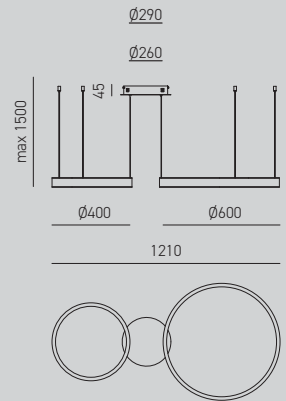
**CRISEIDE S/3D Bianco**

Socket: **6 moduli LED**
 Power: **40W+60W+**
80W=180W
 input: **220/240V**
 Light temp.: **3000°K**
 CRI: **>80**
 Lumen: **9300Lm**
 Pack: **0,065 m³**

CRISEIDE S/3D Oro

Socket: **6 moduli LED**
 Power: **40W+60W+**
80W=180W
 input: **220/240V**
 Light temp.: **3000°K**
 CRI: **>80**
 Lumen: **9100Lm**
 Pack: **0,065 m³**

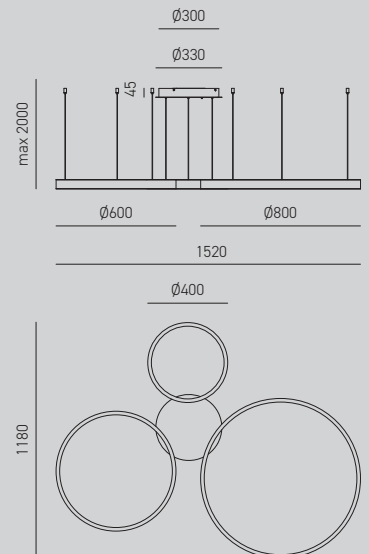

IOLE



Suggestioni spaziali che portano la luce a nuove forme
Spatial influences bringing light to new forms







UN SEGNO GRAFICO,
CHE LASCIA UNA SUA
FIRMA DISTINTIVA
NELLO SCENARIO
DELL'ILLUMINAZIONE
D'INTERNI...

A GRAPHIC SIGN,
WHICH LEAVES ITS OWN
DISTINCTIVE MARK IN THE
INTERIOR LIGHTING...

















IOLE

Montatura in alluminio satinato bianco, oro spazzolato o titanio.
Diffusore in silicone bianco opale.
Sorgente luminosa led dimmerabile a taglio di fase tramite dimmer esterno+push (non inclusi).

Frame in satin white, brushed gold or titanium aluminum.
Opal white silicone diffuser.
Phase cut dimmable LED light source via external dimmer + push (not included).



IOLE S/1

Socket: **1 modulo LED**
Power: **28W**
input: **220/240V**
Lumen: **1510Lm**
CRI: **>80**
Light temp.: **3000°K**
Pack: **0,058 m³**

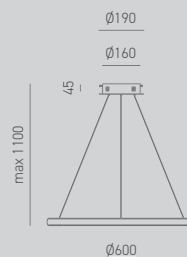

IOLE S/2

Socket: **2 moduli LED**
Power: **42W**
input: **220/240V**
Lumen: **2560Lm**
CRI: **>80**
Light temp.: **3000°K**
Pack: **0,075 m³**

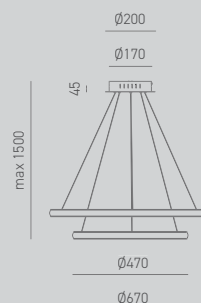

IOLE S/3

Socket: **3 moduli LED**
Power: **62W**
input: **220/240V**
Lumen: **3750Lm**
CRI: **>80**
Light temp.: **3000°K**
Pack: **0,103 m³**

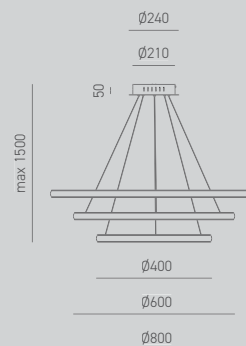

FINISHING

-  Bianco / White
-  Oro Spazzolato / Brushed Gold
-  Titanio / Titanium

IOLE

Struttura in alluminio satinato bianco, oro spazzolato o titanio.
Diffusore in silicone bianco opale.
Sorgente luminosa LED dimmerabile tramite dimmer integrato nel cablaggio.

Structure in white satin, brushed gold or titanium aluminum.
Opal white silicone diffuser.
LED light source dimmable by means of a dimmer integrated in the wiring.

IOLE L



Socket: **1 modulo LED**
Power: **12W**
input: **220/240V**
Lumen: **655Lm**
CRI: **>80**
Light temp.: **3000°K**
Pack: **0,054 m³**

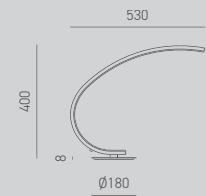

IOLE PT



Socket: **1 modulo LED**
Power: **30W**
input: **220/240V**
Lumen: **1750Lm**
CRI: **>80**
Light temp.: **3000°K**
Pack: **0,142 m³**

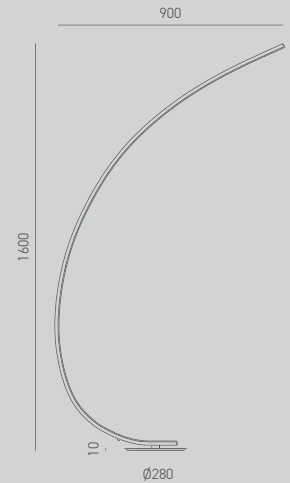

DIVA



Linee fluttuanti che danno vita ad una danza sospesa
Floating lines create suspended movement







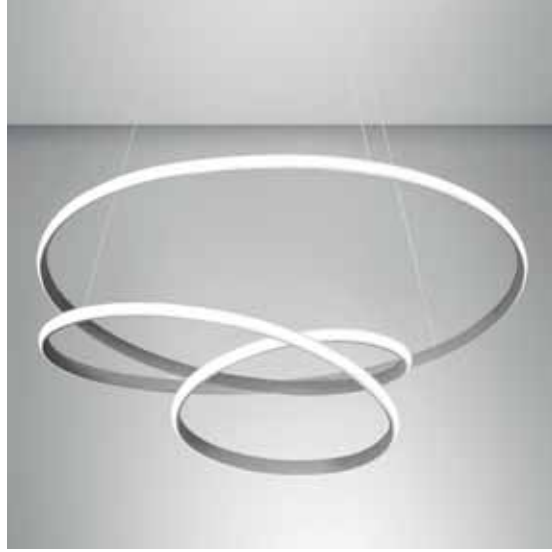







MATERIA LEGGERA,
FIGURA ARIOSI,
LINEE FLUTTUANTI ED
ARMONIOSE. DIVA È
AUTENTICO DESIGN
DETTATO DALLA SUA
FORMA ORGANICA,
CHE DA VITA AD UN
PRODOTTO DI LUCE
AVVOLGENTE E
VIRTUOSO.

LIGHTWEIGHT MATERIAL,
AIRY SILHOUETTE,
HARMONIOUS LINES.
DIVA CONVEYS PURE
DESIGN WITH ITS
ORGANIC FORM TO
CREATE AN ENVELOPING
AND VIRTUOUS PATH OF
LIGHT.





DIVA

Montatura in alluminio bianco satinato, oro spazzolato o titanio.
Diffusore in silicone bianco opale.
Sorgente luminosa led dimmerabile a taglio di fase tramite dimmer esterno + push (non inclusi). Lume dimmerabile tramite dimmer integrato nel cablaggio.

Titanium, brushed gold, satin white aluminium frame.
White opal silicone diffuser.
Phase cut dimmable LED light source via external dimmer+push (not included). Lamp with inline cord dimmer.



DIVA S/P

Socket: **1 modulo LED**
Power: **43W**
input: **220/240V**
Lumen: **2580Lm**
CRI: **>80**
Light temp.: **3000°K**
Pack: **0,051 m³**

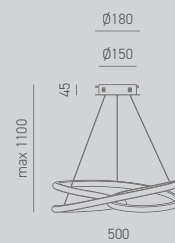

DIVA S/G

Socket: **1 modulo LED**
Power: **44W**
input: **220/240V**
Lumen: **2710Lm**
CRI: **>80**
Light temp.: **3000°K**
Pack: **0,099 m³**

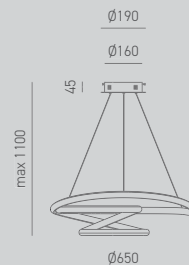

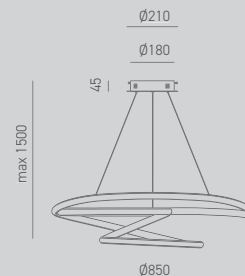

DIVA S/S

Socket: **1 modulo LED**
Power: **80W**
input: **220/240V**
Lumen: **5200Lm**
CRI: **>80**
Light temp.: **3000°K**
Pack: **0,267 m³**



FINISHING

-  Bianco Satinato / Satin White
-  Oro Spazzolato / Brushed Gold
-  Titanio / Titanium

DIVA

DIVA P/P



Socket: **1 modulo LED**
 Power: **42W**
 input: **220/240V**
 Lumen: **2570Lm**
 CRI: **>80**
 Light temp.: **3000°K**
 Pack: **0,072 m³**

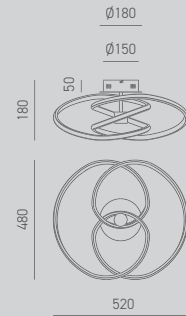

DIVA A



Socket: **1 modulo LED**
 Power: **20W**
 input: **220/240V**
 Lumen: **1470Lm**
 CRI: **>80**
 Light temp.: **3000°K**
 Pack: **0,020 m³**

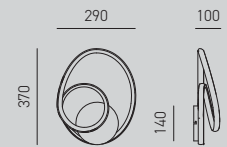

NEW

DIVA L



Socket: **1 modulo LED**
 Power: **17W**
 input: **220/240V**
 Lumen: **920Lm**
 CRI: **>80**
 Light temp.: **3000°K**
 Pack: **0,038 m³**



KRIZIA



La perfezione del cerchio esaltata dalla luce
The perfection of the circle enhanced by light





GEOMETRIE PERFETTE,
COMPOSTE DA UNA
SERIE DI PUNTI
LED EQUIDISTANTI
DA UN CENTRO,
COMPLETAMENTE
AVVOLTI DA UNA
PARTICOLARE
STRUTTURA IN
ALLUMINIO.

PERFECT GEOMETRIES,
COMPOSED OF A
SERIES OF LED LIGHT
POINTS THAT ARE
EQUIDISTANT FROM THE
CENTRE, COMPLETELY
ENVELOPED BY A UNIQUE
ALUMINIUM STRUCTURE.









KRIZIA

Montatura in alluminio satinato bianco o oro spazzolato.
Diffusore in acrilico bianco opale.
Sorgente luminosa led dimmerabile a taglio di fase tramite dimmer esterno+push (non incluso).

Brushed gold or white satin-finish aluminium frame.
White opal acrylic diffuser.
Phase cut dimmable LED light source via external dimmer+push (not included).



KRIZIA S/P Bianco

Socket: **1 modulo LED**
Power: **38W**
Input: **220/240V**
Lumen: **2300Lm**
CRI: **>80**
Light temp.: **3000°K**
Pack: **0,026 m³**

KRIZIA S/P Oro

Socket: **1 modulo LED**
Power: **38W**
Input: **220/240V**
Lumen: **2200Lm**
CRI: **>80**
Light temp.: **3000°K**
Pack: **0,026 m³**

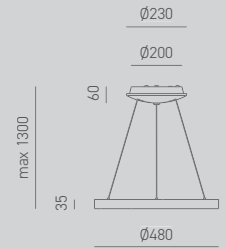

KRIZIA S/M Bianco

Socket: **1 modulo LED**
Power: **50W**
Input: **220/240V**
Lumen: **2900Lm**
CRI: **>80**
Light temp.: **3000°K**
Pack: **0,038 m³**

KRIZIA S/M Oro

Socket: **1 modulo LED**
Power: **50W**
Input: **220/240V**
Lumen: **2800Lm**
CRI: **>80**
Light temp.: **3000°K**
Pack: **0,038 m³**

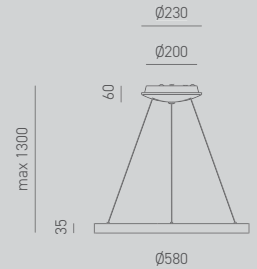

KRIZIA S/G Bianco

Socket: **1 modulo LED**
Power: **60W**
Input: **220/240V**
Lumen: **4800Lm**
CRI: **>80**
Light temp.: **3000°K**
Pack: **0,064 m³**

KRIZIA S/G Oro

Socket: **1 modulo LED**
Power: **60W**
Input: **220/240V**
Lumen: **4600Lm**
CRI: **>80**
Light temp.: **3000°K**
Pack: **0,064 m³**

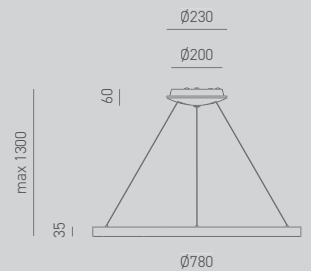

KRIZIA S/2 Bianco

Socket: **2 moduli LED**
Power: **38W+**
50W=88W
Input: **220/240V**
Lumen: **6300Lm**
CRI: **>80**
Light temp.: **3000°K**
Pack: **0,038 m³**

KRIZIA S/2 Oro

Socket: **2 moduli LED**
Power: **38W+**
50W=88W
Input: **220/240V**
Lumen: **6000Lm**
CRI: **>80**
Light temp.: **3000°K**
Pack: **0,038 m³**

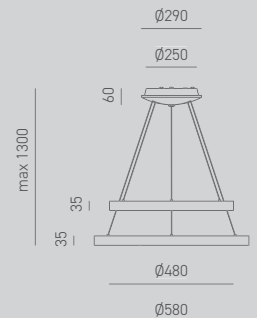

FINISHING



Bianco Satinato / Satin White



Oro Spazzolato / Brushed Gold

KRIZIA

Montatura in alluminio satinato bianco, nero o oro spazzolato.
Versione bianca disponibile in 4000K.
Diffusore in acrilico bianco opale.
Sorgente luminosa led dimmerabile a taglio di fase tramite dimmer esterno+push (non incluso).

Brushed gold, black or white satin-finish aluminium frame.
White version available in 4000K.
White opal acrylic diffuser.
Phase cut dimmable LED light source via external dimmer+push (not included).



KRIZIA P/P Bianco 3000°K KRIZIA P/P Bianco 4000°K

Socket:	1 modulo LED	1 modulo LED
Power:	max 30W	30W
input:	220/240V	220/240V
Light temp.:	3000°K	4000°K
CRI:	>80	>80
Lumen:	2600Lm	2700Lm
Pack:	0,014 m³	0,014 m³



NEW



KRIZIA P/M Bianco 3000°K KRIZIA P/M Bianco 4000°K

Socket:	1 modulo LED	1 modulo LED
Power:	max 38W	38W
input:	220/240V	220/240V
Light temp.:	3000°K	4000°K
CRI:	>80	>80
Lumen:	3300Lm	3400Lm
Pack:	0,022 m³	0,022 m³

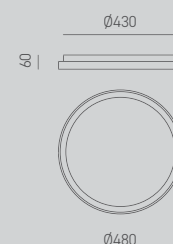

NEW



KRIZIA P/G Bianco 3000°K KRIZIA P/G Bianco 4000°K

Socket:	1 modulo LED	1 modulo LED
Power:	max 50W	50W
input:	220/240V	220/240V
Light temp.:	3000°K	4000°K
CRI:	>80	>80
Lumen:	4100Lm	4200Lm
Pack:	0,032 m³	0,032 m³

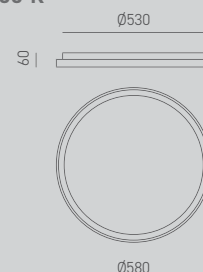

NEW



KRIZIA P/S Bianco 3000°K KRIZIA P/S Bianco 4000°K

Socket:	1 modulo LED	1 modulo LED
Power:	max 60W	60W
input:	220/240V	220/240V
Light temp.:	3000°K	4000°K
CRI:	>80	>80
Lumen:	5300Lm	5500Lm
Pack:	0,056 m³	0,056 m³

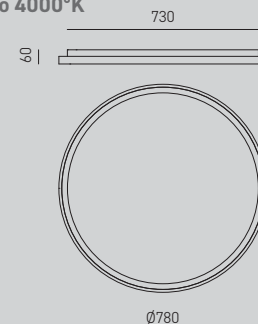

NEW



KRIZIA P/X Bianco 3000°K KRIZIA P/X Bianco 4000°K

Socket:	1 modulo LED	1 modulo LED
Power:	80W	80W
input:	220/240V	220/240V
Light temp.:	3000°K	4000°K
CRI:	>80	>80
Lumen:	5800Lm	6100Lm
Pack:	0,100 m³	0,100 m³

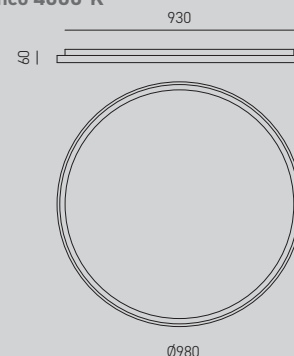

NEW

NEW

FINISHING





Bianco Satinato / Satin White

KRIZIA

	<p>KRIZIA P/P Nero</p> <p>Socket: 1 modulo LED Power: 30W input: 220/240V Light temp.: 3000°K CRI: >80 Lumen: 2400Lm Pack: 0,014 m³</p> <p>NEW</p>	<p>KRIZIA P/P Oro</p> <p>Socket: 1 modulo LED Power: 30W input: 220/240V Light temp.: 3000°K CRI: >80 Lumen: 2500Lm Pack: 0,014 m³</p>	
	<p>KRIZIA P/M Nero</p> <p>Socket: 1 modulo LED Power: 38W input: 220/240V Light temp.: 3000°K CRI: >80 Lumen: 3100Lm Pack: 0,022 m³</p> <p>NEW</p>	<p>KRIZIA P/M Oro</p> <p>Socket: 1 modulo LED Power: 38W input: 220/240V Light temp.: 3000°K CRI: >80 Lumen: 3200Lm Pack: 0,022 m³</p>	
	<p>KRIZIA P/G Nero</p> <p>Socket: 1 modulo LED Power: 50W input: 220/240V Light temp.: 3000°K CRI: >80 Lumen: 3900Lm Pack: 0,032 m³</p> <p>NEW</p>	<p>KRIZIA P/G Oro</p> <p>Socket: 1 modulo LED Power: 50W input: 220/240V Light temp.: 3000°K CRI: >80 Lumen: 4000Lm Pack: 0,032 m³</p>	
	<p>KRIZIA P/S Nero</p> <p>Socket: 1 modulo LED Power: 60W input: 220/240V Light temp.: 3000°K CRI: >80 Lumen: 5000Lm Pack: 0,056 m³</p> <p>NEW</p>	<p>KRIZIA P/S Oro</p> <p>Socket: 1 modulo LED Power: 60W input: 220/240V Light temp.: 3000°K CRI: >80 Lumen: 5100Lm Pack: 0,056 m³</p>	
	<p>KRIZIA P/X Nero</p> <p>Socket: 1 modulo LED Power: 80W input: 220/240V Light temp.: 3000°K CRI: >80 Lumen: 5400Lm Pack: 0,100 m³</p> <p>NEW</p>	<p>KRIZIA P/X Oro</p> <p>Socket: 1 modulo LED Power: 80W input: 220/240V Light temp.: 3000°K CRI: >80 Lumen: 5600Lm Pack: 0,100 m³</p> <p>NEW</p>	

FINISHING

 Nero Satinato / Satin Black

 Oro Spazzolato / Brushed Gold

YARA



**Un'intreccio d'orizzonti fatto di stile
e geometrica precisione**
Interwoven horizons of style
and geometric precision

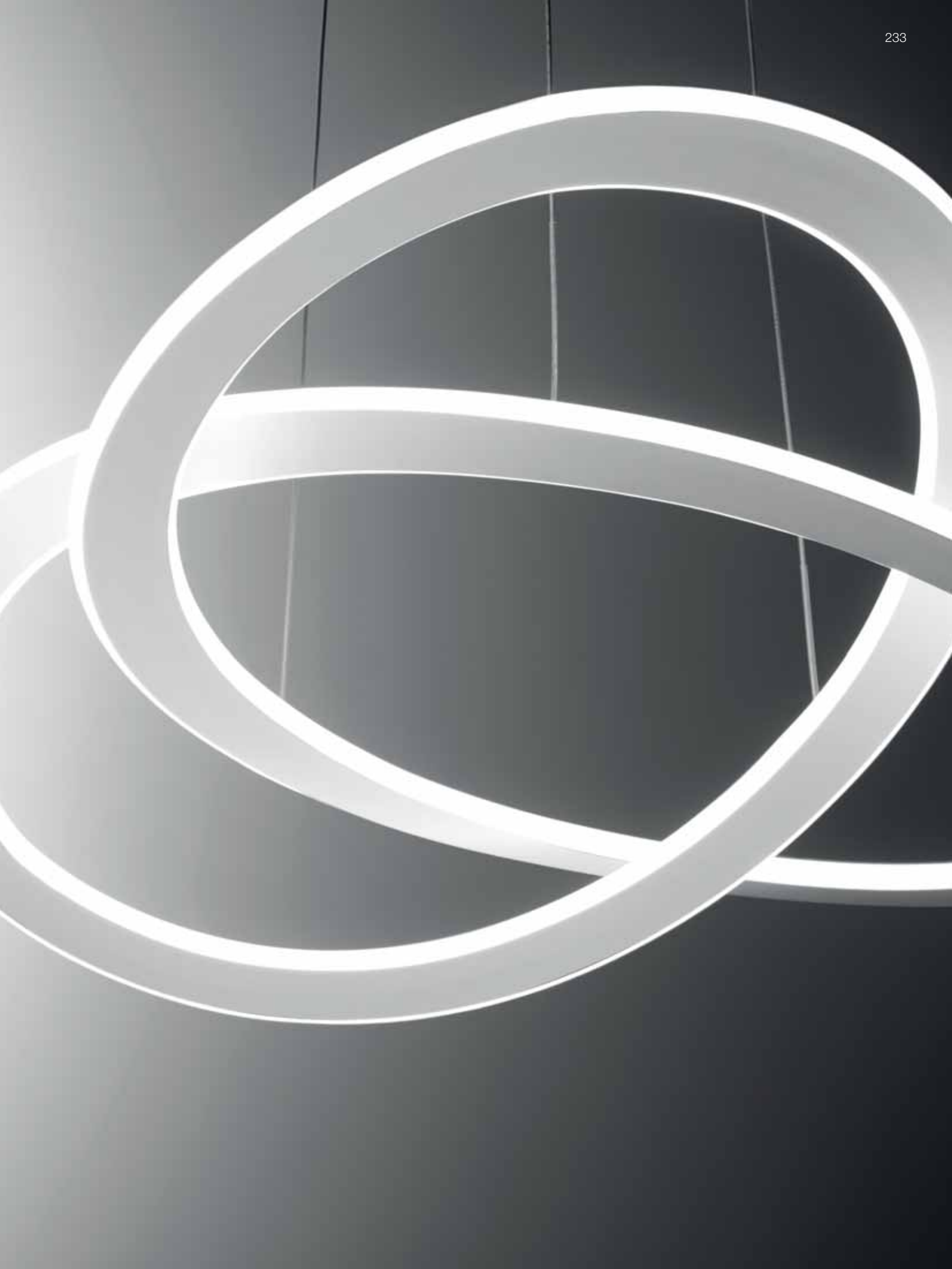





LA PARTICOLARE
LUCE LED CONTINUA,
INTERNA ED ESTERNA
AL PROFILO DELLA
STRUTTURA, AMPLIFICA
LA RESA LUMINOSA
EVIDENZIANDO IL
DESIGN AVVENIRISTICO
DI QUESTO INTRIGANTE
PRODOTTO.

THE SPECIAL CONSTANT
LED LIGHT, INSIDE AND
OUTSIDE THE PROFILE
OF THE STRUCTURE,
AMPLIFIES THE LIGHT
OUTPUT, HIGHLIGHTING
THE FUTURISTIC DESIGN
OF THIS INTRIGUING
PRODUCT.

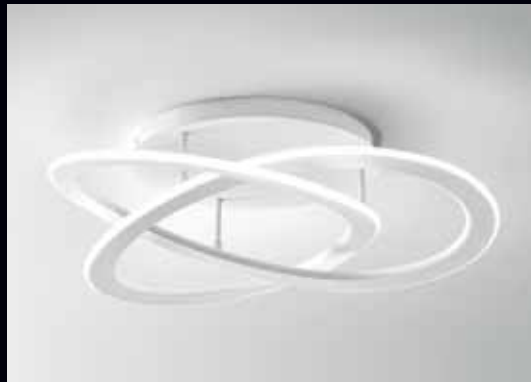

YARA

Montatura in alluminio satinato bianco.
Diffusore in silicone bianco opale.
Sorgente luminosa led dimmerabile a taglio di fase tramite dimmer esterno + push (non inclusi).

Frame in satin white, opal white silicone diffuser. Phase cut dimmable led light source via external dimmer + push (not included).



YARA P/P C

Socket: **1 modulo LED**
Power: **30W**
Input: **220/240V**
Lumen: **1300Lm**
CRI: **>80**
Light temp.: **3000°K**
Pack: **0,073 m³**

YARA P/P N

Socket: **1 modulo LED**
Power: **30W**
Input: **220/240V**
Lumen: **1400Lm**
CRI: **>80**
Light temp.: **4000°K**
Pack: **0,073 m³**

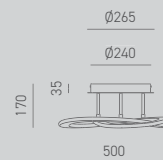

YARA P/M C

Socket: **1 modulo LED**
Power: **40W**
Input: **220/240V**
Lumen: **1900Lm**
CRI: **>80**
Light temp.: **3000°K**
Pack: **0,101 m³**

YARA P/M N

Socket: **1 modulo LED**
Power: **40W**
Input: **220/240V**
Lumen: **2000Lm**
CRI: **>80**
Light temp.: **4000°K**
Pack: **0,101 m³**

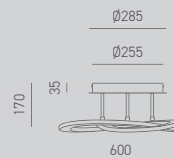

YARA P/G C

Socket: **1 modulo LED**
Power: **50W**
Input: **220/240V**
Lumen: **2400Lm**
CRI: **>80**
Light temp.: **3000°K**
Pack: **0,133 m³**

YARA P/G N

Socket: **1 modulo LED**
Power: **50W**
Input: **220/240V**
Lumen: **2500Lm**
CRI: **>80**
Light temp.: **4000°K**
Pack: **0,133 m³**

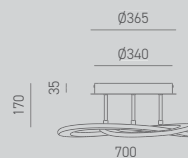

YARA S/P C

Socket: **1 modulo LED**
Power: **40W**
Input: **220/240V**
Lumen: **1900Lm**
CRI: **>80**
Light temp.: **3000°K**
Pack: **0,070 m³**

YARA S/P N

Socket: **1 modulo LED**
Power: **40W**
Input: **220/240V**
Lumen: **2000Lm**
CRI: **>80**
Light temp.: **4000°K**
Pack: **0,070 m³**

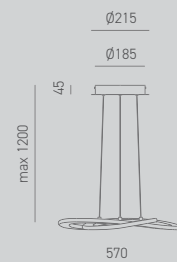

YARA S/G C

Socket: **1 modulo LED**
Power: **50W**
Input: **220/240V**
Lumen: **2400Lm**
CRI: **>80**
Light temp.: **3000°K**
Pack: **0,092 m³**

YARA S/G N

Socket: **1 modulo LED**
Power: **50W**
Input: **220/240V**
Lumen: **2500Lm**
CRI: **>80**
Light temp.: **4000°K**
Pack: **0,092 m³**

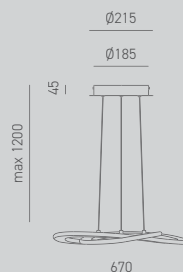

FINISHING



Bianco Satinato / Satin White

EMILY



Tagli di luce per un raffinato design contemporaneo
Lines of light create a refined, contemporary design





IL FASCIO DI LUCE
EMESSO DALLA
SORGENTE LUMINOSA
VIENE SAPIENTEMENTE
FILTRATO DAL
DIFFUSORE OPALINO,
RENDENDOLO
CONFORTEVOLE ANCHE
ALLA VISTA DIRETTA.

THE BEAM OF LIGHT
EMITTED BY THE LIGHT
SOURCE IS EXPERTLY
FILTERED BY THE OPAL
DIFFUSER, ENSURING
EYE COMFORT EVEN
WHEN IT IS IN DIRECT
VIEW.

EMILY

Montatura in metallo satinato bianco
o satinato nero.
Diffusore in acrilico.
Lampadina non inclusa.

Satin white or satin black metal frame.
Acrylic diffuser.
Bulb not included.



EMILY P

Socket: **1xGU10**
Power: **max 35W**
input: **220/240V**
Pack: **0,002 m³**



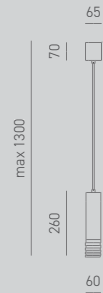

EMILY S

Socket: **1xGU10**
Power: **max 35W**
input: **220/240V**
Pack: **0,003 m³**



FINISHING

 Bianco / White

 Nero / Black





SOSPENSIONI

NEW

JULIETTE



Una promessa di eterna bellezza
A promise of eternal beauty









JULIETTE

Montatura in alluminio satinato bianco o nero con interno oro spazzolato.
Diffusore in silicone bianco opale.
Sorgente luminosa led dimmerabile a taglio di fase tramite dimmer esterno+push (non inclusi).

White or black satin-finish aluminium frame with internal brushed gold surface.
White opal silicone diffuser.
Dimmable LED light source phase cut via an external dimmer+push (not included).



JULIETTE S Bianco

Socket: **1 modulo LED**
Power: **50W**
input: **220/240V**
Light temp.: **3000°K**
CRI: **>80**
Lumen: **2200Lm**
Pack: **0,058 m³**

JULIETTE S Nero

1 modulo LED
50W
220/240V
3000°K
>80
2300Lm
0,058 m³

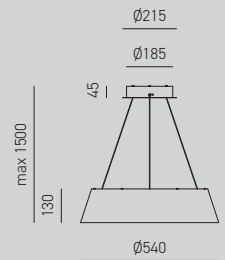

FINISHING

 **Bianco Satinato - Bianco Satinato**
Satin White - Satin White

 **Nero Satinato - Oro**
Satin Black - Gold

BONELLA



Un generoso abbraccio di luce
A generous embrace of light





BONELLA È LA LAMPADA A SOSPENSIONE DALLE DIMENSIONI GENEROSE CHE SI DISTINGUE PER LA SUA RAFFINATEZZA. GRAZIE AL SUO INTERNO VERNICIATO BIANCO PROPONE UN GRADEVOLISSIMO CHIARORE, ARREDANDO OGNI AMBIENTE CON NATURALEZZA.

BONELLA IS A PENDAN LAMP WITH GENEROUS DIMENSIONS THAT STANDS OUT FOR ITS ELEGANCE. IT OFFERS A CHARMING GLOW THANKS TO ITS WHITE PAINTED INTERIOR, AND THE TWO DIAMETERS AVAILABLE FURNISH ANY ENVIRONMENT WITH A NATURAL QUALITY.

BONELLA

Sospensione con montatura in alluminio.
 Finiture: Bianco opaco esterno/bianco opaco interno, rosone bianco opaco.
 Nero opaco esterno/bianco opaco interno, rosone nero opaco. Ottone esterno/bianco opaco interno, rosone ottone.
 Rame esterno/bianco opaco interno, rosone rame.
 Lampadina non inclusa.

Suspension lighting with aluminium frame.
 Finishes: Matt white outside/matt white inside, matt white canopy.
 Matt black outside/matt white inside, matt black canopy.
 Brass outside/matt white inside, brass canopy. Copper outside/matt white inside, copper canopy.
 Bulb not included.





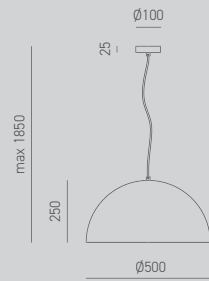

BONELLA S/P

Socket: **1xE27**
 Power: **max 60W**
 Input: **220/240V**
 Pack: **0,091 m³**



FINISHING

-  Bianco-Bianco / White-White
-  Nero-Bianco / Black-White
-  Ottone-Bianco / Brass-White
-  Rame-Bianco / Copper-White



BLANCA



**La forma della tradizione incontra la stilizzazione
del contemporaneo**
Traditional forms meet contemporary styling





BLANCA

Sospensione con montatura in alluminio.
 Finiture: Bianco opaco esterno/bianco opaco interno, rosone bianco opaco.
 Nero opaco esterno/bianco opaco interno, rosone nero opaco. Ottone esterno/bianco opaco interno, rosone ottone. Nickel esterno/bianco opaco interno, rosone nickel. Lampadina non inclusa.

Suspension lighting with aluminium frame.
 Finishes: Matt white outside/matt white inside, matt white canopy.
 Matt black outside/matt white inside, matt black canopy. Brass outside/matt white inside, brass canopy. Nickel outside/matt white inside, nickel canopy.
 Bulb not included.





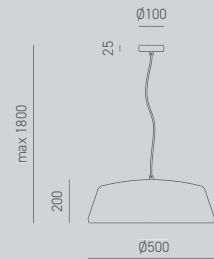

BLANCA S/P

Socket: **1xE27**
 Power: **max 60W**
 Input: **220/240V**
 Pack: **0,076 m³**



FINISHING

-  Bianco-Bianco / White-White
-  Nero-Bianco / Black-White
-  Ottone-Bianco / Brass-White
-  Nickel-Bianco / Nickel-White



BARBIE



Il fascino brioso dalle linee essenziali
Sparkling charm with essential lines





BARBIE

Sospensione con montatura in alluminio.
 Finiture: Bianco opaco esterno/bianco opaco interno, rosone bianco.
 Nero opaco esterno/bianco opaco interno, rosone nero opaco.
 Ottone esterno/bianco opaco interno, rosone ottone.
 Rame esterno/bianco opaco interno, rosone rame.
 Lampadina non inclusa.

Suspension lighting with aluminium frame.
 Finishes: Matt white outside/matt white inside, matt white canopy.
 Matt black outside/matt white inside, matt black canopy.
 Brass outside/matt white inside brass canopy.
 Copper outside/matt white inside, copper canopy.
 Bulb not included.



BARBIE S/P

Socket: **1xE27**
 Power: **max 60W**
 Input: **220/240V**
 Pack: **0,037 m³**

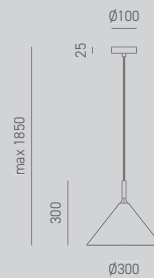



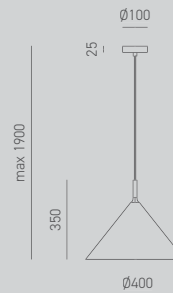

BARBIE S/G

Socket: **1xE27**
 Power: **max 60W**
 Input: **220/240V**
 Pack: **0,073 m³**



FINISHING

-  Bianco-Bianco / White-White
-  Nero-Bianco / Black-White
-  Ottone-Bianco / Brass-White
-  Rame-Bianco / Copper-White

CINZIA



Una danza elegante tra la luce e il metallo
An elegant dance between light and metal





UN RAFFINATO STILE
CLASSICO RIVISTO
E REINTERPRETATO
IN AMBITO
CONTEMPORANEO CHE
DECORA ED ARREDA
OGNI AMBIENTE.

A REFINED CLASSIC
STYLE, REVISED AND
REINTERPRETED IN
A CONTEMPORARY
CONTEXT, TO DECORATE
AND FURNISH ANY
ENVIRONMENT.

CINZIA

Montatura in alluminio bianco satinato o oro spazzolato.
Diffusore in silicone bianco opale.
Sorgente luminosa led;
dimmerabile a taglio di fase
tramite dimmer esterno + push
(non inclusi).

Frame in satin white aluminium
or brushed gold.

Opal white silicone diffuser.

Phase cut dimmable led light source
via external dimmer + push-button
(not included).



CINZIA S

Socket: **4 moduli LED**
Power: **46W**
input: **220/240V**
Lumen: **2300Lm**
CRI: **>80**
Light temp.: **3000°K**
Pack: **0,148 m³**

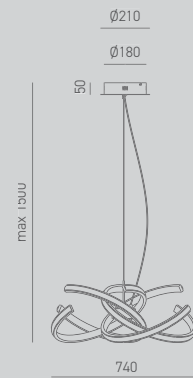

FINISHING



Bianco Satinato / Satin White



Oro Spazzolato / Brushed Gold





SOFFITTO PARETE

NEW

FLOR

Luce diffusa modellata nell'eleganza del cerchio
Diffused light in the elegance of a circle









FLOR

Montatura in alluminio satinato bianco, nero o oro spazzolato.
 Diffusore in metacrilato bianco opale.
 Sorgente luminosa led dimmerabile a taglio di fase tramite dimmer esterno+push (non inclusi).

Brushed gold, black or white satin-finish aluminium frame. White opal methacrylate diffuser. Phase cut dimmable LED light source via external dimmer+push (not included).



	FLOR P/P Bianco	FLOR P/P Nero	FLOR P/P Oro
Socket:	1 modulo LED	1 modulo LED	1 modulo LED
Power:	30W	30W	30W
input:	220/240V	220/240V	220/240V
Light temp.:	3000°K	3000°K	3000°K
CRI:	>80	>80	>80
Lumen:	2300Lm	2100Lm	2200Lm
Pack:	0,020 m ³	0,020 m ³	0,020 m ³

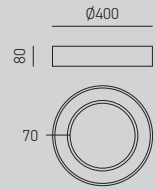

	FLOR P/M Bianco	FLOR P/M Nero	FLOR P/M Oro
Socket:	1 modulo LED	1 modulo LED	1 modulo LED
Power:	50W	50W	50W
input:	220/240V	220/240V	220/240V
Light temp.:	3000°K	3000°K	3000°K
CRI:	>80	>80	>80
Lumen:	3700Lm	3500Lm	3600Lm
Pack:	0,043 m ³	0,043 m ³	0,043 m ³

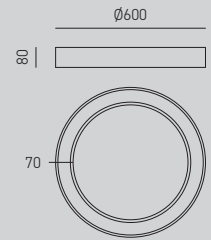

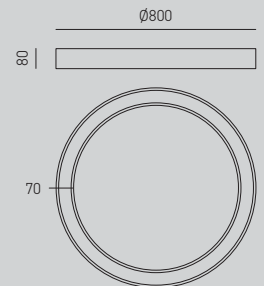

	FLOR P/G Bianco	FLOR P/G Nero	FLOR P/G Oro
Socket:	1 modulo LED	1 modulo LED	1 modulo LED
Power:	60W	60W	60W
input:	220/240V	220/240V	220/240V
Light temp.:	3000°K	3000°K	3000°K
CRI:	>80	>80	>80
Lumen:	4300Lm	4100Lm	4200Lm
Pack:	0,074 m ³	0,074 m ³	0,074 m ³

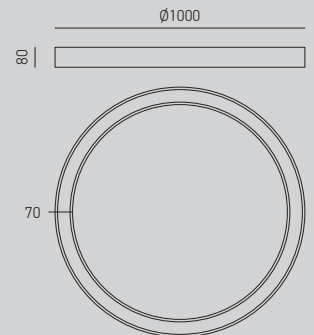

	FLOR P/S Bianco	FLOR P/S Nero	FLOR P/S Oro
Socket:	1 modulo LED	1 modulo LED	1 modulo LED
Power:	80W	80W	80W
input:	220/240V	220/240V	220/240V
Light temp.:	3000°K	3000°K	3000°K
CRI:	>80	>80	>80
Lumen:	6300Lm	6100Lm	6200Lm
Pack:	0,126 m ³	0,126 m ³	0,126 m ³



FINISHING

-  Bianco Satinato / Satin White
-  Nero Satinato / Satin Black
-  Oro Spazzolato / Brushed Gold

RAKE

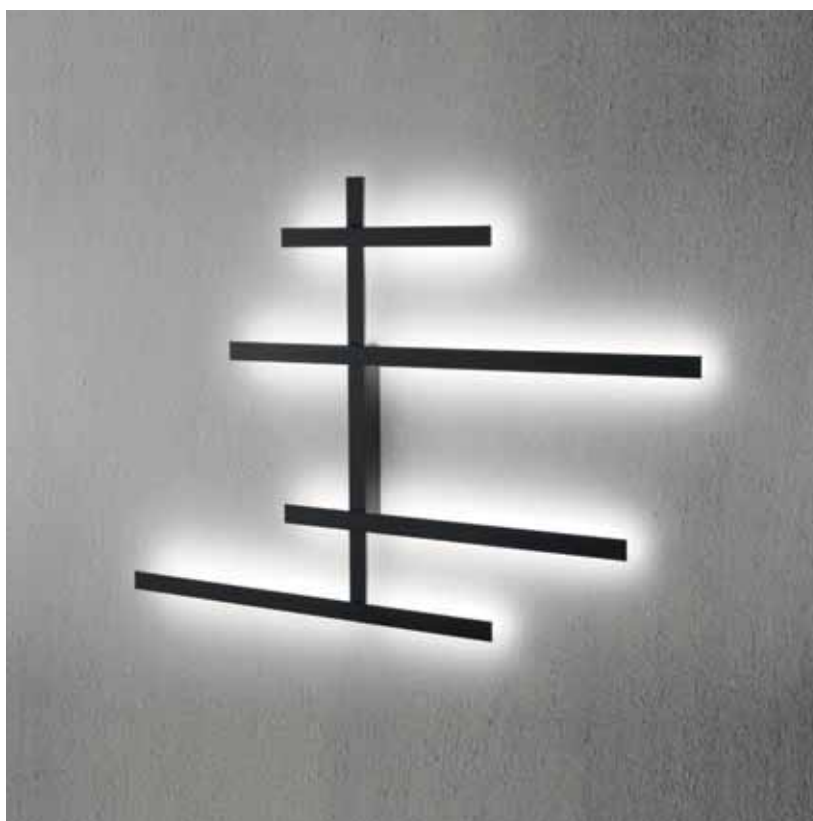

Luce grafica e massima libertà espressiva
Graphic light: the ultimate freedom of expression











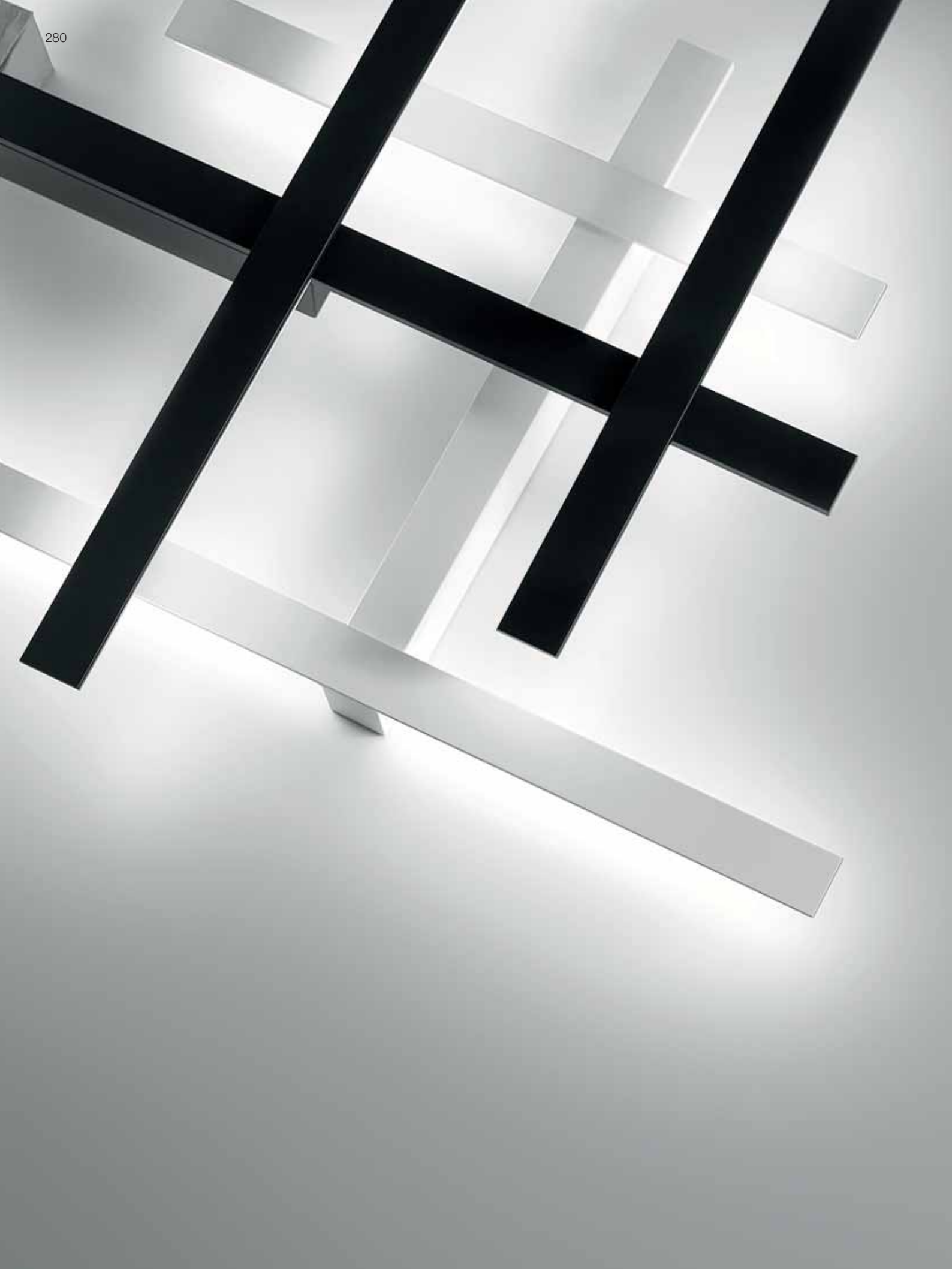

RAKE

Lampada con struttura in alluminio, diffusore in metacrilato.
Disponibile nei colori bianco opaco, nero opaco ed anticato acciaio.
Sorgente luminosa LED con alimentatore dimmerabile incluso (Push).
Illuminazione indiretta.

Lamp with aluminium structure and metacrylate diffuser.
Available in matt white, matt black and antique steel.
LED light source with dimmable ballast included (Push).
Indirect illumination.



RAKE AL

Socket: **3 strip LED**
Power: **33,8W**
input: **220/240V**
Lumen: **4056Lm**
CRI: **>80**
Light temp.: **3000°K**
Pack: **0,069 m³**

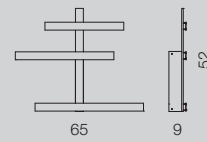

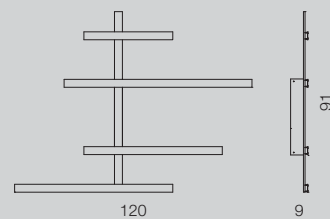

RAKE AXL

Socket: **4 strip LED**
Power: **70,2W**
input: **220/240V**
Lumen: **8424Lm**
CRI: **>80**
Light temp.: **3000°K**
Pack: **0,043 m³**



FINISHING

-  Bianco opaco / Matt white
-  Nero opaco / Matt black
-  Acciaio anticato / Antique steel

NEW

SHEILA



La semplicità che sta bene ovunque
Simplicity that looks good everywhere

SHEILA

Montatura in alluminio satinato bianco.
Diffusore in metacrilato bianco opale.
Sorgente luminosa led dimmerabile a taglio di fase tramite dimmer esterno+push (non inclusi).

White satin-finish aluminium frame.
White opal methacrylate diffuser.
Phase cut dimmable LED light source via external dimmer+push (not included).



SHEILA P/P

Socket: **1 modulo LED**
Power: **38W**
input: **220/240V**
Light temp.: **3000°K**
CRI: **>80**
Lumen: **3000Lm**
Pack: **0,034 m³**

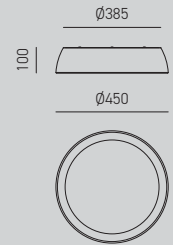

SHEILA P/G

Socket: **1 modulo LED**
Power: **50W**
input: **220/240V**
Light temp.: **3000°K**
CRI: **>80**
Lumen: **4100Lm**
Pack: **0,067 m³**

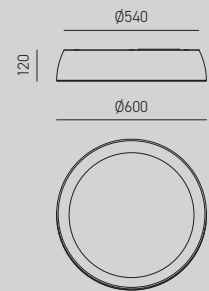

FINISHING



Bianco opaco / Matt white

NEW

ENILA



Tracce di luce riflesse in linee sottili
Traces of light reflected in fine lines





ENILA

Montatura in alluminio bianco satinato, oro spazzolato o titanio.
Diffusore in silicone bianco opale.
Sorgente luminosa led dimmerabile a taglio di fase tramite dimmer esterno + push (non inclusi).

Titanium, brushed gold, satin white aluminium frame. White opal silicone diffuser. Phase cut dimmable LED light source via external dimmer+push (not included).



ENILA A Bianco / White

Socket: **1 modulo LED**
Power: **20W**
input: **220/240V**
Light temp.: **3000°K**
CRI: **>80**
Lumen: **1410Lm**
Pack: **0,020 m³**

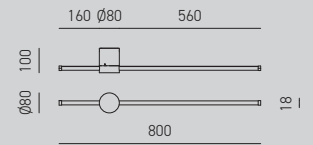



ENILA A Titanio / Titanium

Socket: **1 modulo LED**
Power: **20W**
input: **220/240V**
Light temp.: **3000°K**
CRI: **>80**
Lumen: **1320Lm**
Pack: **0,020 m³**

ENILA A Oro / Gold

Socket: **1 modulo LED**
Power: **20W**
input: **220/240V**
Light temp.: **3000°K**
CRI: **>80**
Lumen: **1150Lm**
Pack: **0,020 m³**

FINISHING

-  Bianco Satinato / Satin White
-  Oro Spazzolato / Brushed Gold
-  Titanio / Titanium

NEW

FORTUNA



Figura piena e pulita per un effetto magnetico
A full, clean shape creates a magnetic effect





FORTUNA

Montatura in metallo bianco satinato, oro spazzolato o nero.
Diffusore in metacrilato bianco opale.
Sorgente luminosa led dimmerabile a taglio di fase tramite dimmer esterno + push (non inclusi).

Black, brushed gold or satin white metal frame.
White opal methacrylate diffuser.
Phase cut dimmable LED light source via external dimmer+push (not included).



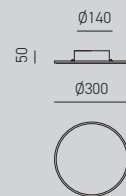

	FORTUNA A/P Bianco	Nero	Oro
Socket:	1 modulo LED	1 modulo LED	1 modulo LED
Power:	20W	20W	20W
input:	220/240V	220/240V	220/240V
Light temp.:	3000°K	3000°K	3000°K
CRI:	>80	>80	>80
Lumen:	1640Lm	1320Lm	1550Lm
Pack:	0,010 m ³	0,010 m ³	0,010 m ³



	FORTUNA A/G Bianco	Nero	Oro
Socket:	1 modulo LED	1 modulo LED	1 modulo LED
Power:	28W	28W	28W
input:	220/240V	220/240V	220/240V
Light temp.:	3000°K	3000°K	3000°K
CRI:	>80	>80	>80
Lumen:	2560Lm	1850Lm	2270Lm
Pack:	0,016 m ³	0,016 m ³	0,016 m ³



FINISHING

-  Bianco Satinato / Satin White
-  Oro Spazzolato / Brushed Gold
-  Nero / Black

PLUG



Frizzante al punto giusto
Just the right amount of sparkle



UN PUNTO LUCE
D'EFFETTO CHE PIEGA
IL METALLO AL SERVIZIO
DELLA CREATIVITÀ. PLUG
STAPPA LA VOGLIA DI
ALLEGRIA E MODERNITÀ.

A STRIKING SPOTLIGHT
EFFECT THAT BENDS
METAL TO THE SERVICE
OF CREATIVITY. PLUG
UNLEASHES THE
DESIRE FOR JOY AND
MODERNITY.



PLUG

Lampada con struttura in alluminio pressofuso, diffusore in metacrilato. Disponibile nei colori bianco opaco, nero opaco, oro opaco ed anticato acciaio. Sorgente luminosa COB LED dimmerabile a taglio di fase tramite dimmer esterno + push (non inclusi). Illuminazione indiretta.

Lamp with die-cast aluminium structure and metacrylate diffuser. Available in matt white, matt black, matt gold and antique steel. Phase cut dimmable COB LED light source via external dimmer + push (not included). Indirect illumination.



PLUG A

Socket: **1 COB LED**
 Power: **20W**
 input: **220/240V**
 Lumen: **1800lm**
 CRI: **>80**
 Light temp.: **3000°K**
 Pack: **0,013 m³**

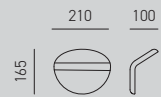

FINISHING

-  **Bianco opaco / Matt white**
-  **Nero opaco / Matt black**
-  **Acciaio anticato / Antique steel**
-  **Oro opaco / Matt gold**

BABOL



**Linee morbide e dimensioni contenute
per spiriti giovani**
Soft lines and small size, for the young at heart





UN CONCENTRATO DI
LUCE E TECNOLOGIA
RACCHIUSE IN 11 CM.
BABOL ESPRIME TUTTO
IL SUO POTENZIALE
ESTETICO IN
POCHISSIMO SPAZIO.

A CONCENTRATION OF
LIGHT AND TECHNOLOGY
ENCLOSED IN A SPACE
OF JUST 11 CM. BABOL
EXPRESSES ITS FULL
AESTHETIC POTENTIAL
DESPITE ITS LIMITED SIZE.

BABOL

Lampada con struttura in alluminio pressofuso, diffusore in metacrilato. Disponibile nei colori bianco opaco, nero opaco, oro opaco ed anticato acciaio. Sorgente luminosa lampadine Gx53 LED 3000K incluse. Illuminazione indiretta.

Lamp with die-cast aluminium structure and metacrylate diffuser. Available in matt white, matt black, matt gold and antique steel. Gx53 LED 3000K light source. Bulbs included. Indirect illumination.



BABOL A

Socket: **2xGx53**
 Power: **2x8W = 16W**
 input: **220/240V**
 Light temp.: **3000°K**
 Pack: **0,010 m³**

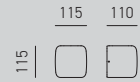

FINISHING

-  **Bianco opaco** / Matt white
-  **Nero opaco** / Matt black
-  **Acciaio anticato** / Antique steel
-  **Oro opaco** / Matt gold

NEW

YOANA

**Luce diffusa ad effetto
mimetico**

Diffused light with
camouflage effect



YOANA

Montatura in metallo bianco satinato, ottone o titanio. Diffusore in metacrilato bianco opale. Sorgente luminosa led dimmerabile a taglio di fase tramite dimmer esterno + push (non inclusi).

White metal satin, brass or titanium frame.
White opal methacrylate diffuser.
Phase cut dimmable LED light source via external dimmer+push (not included).



YOANA A/P

Socket: **1 modulo LED**
Power: **15W**
input: **220/240V**
Light temp.: **3000°K**
CRI: **>80**
Lumen: **1500Lm**
Pack: **0,0009 m³**

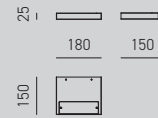

YOANA A/G

Socket: **1 modulo LED**
Power: **25W**
input: **220/240V**
Light temp.: **3000°K**
CRI: **>80**
Lumen: **2600Lm**
Pack: **0,0015 m³**

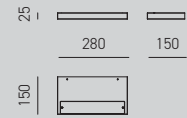

FINISHING

-  Bianco Satinato / Satin White
-  Ottone / Brass
-  Titanio / Titanium

DOHA



Illuminare e arredare con l'arte espressionista
Illuminate and furnish with expressionist art

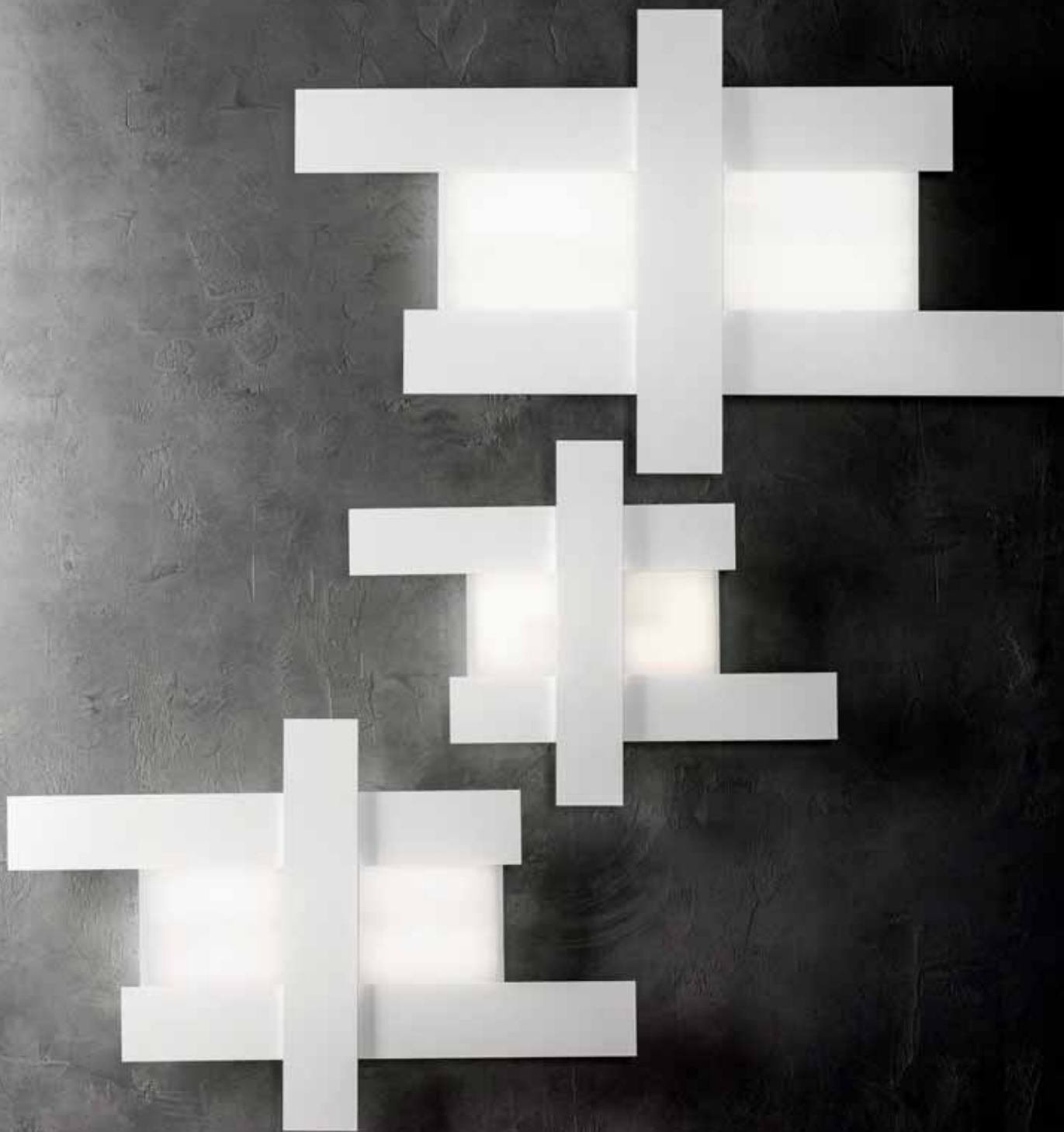



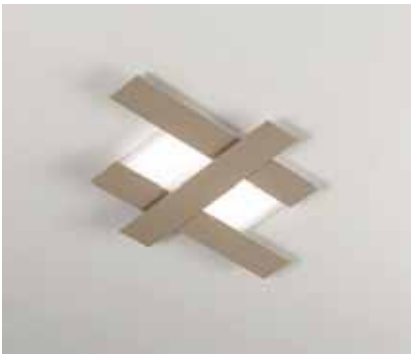

DESIGN RIGIDO,
LINEARITÀ
CONVENZIONALI
MA AL CONTEMPO
INDEFINITE PER
QUESTA COLLEZIONE
CHE RIEVOCA IL
CUBISMO NELLA
SUA RICERCA DELLA
SEMPLIFICAZIONE.

DOHA FEATURES
STRICT DESIGN AND
CONVENTIONAL
LINEARITY, WHICH
IS SIMULTANEOUSLY
UNDEFINED. THIS
COLLECTION EVOKES
CUBISM IN ITS SEARCH
FOR SIMPLIFICATION.











DOHA

Montatura in alluminio bianco.
Diffusore in metacrilato bisatinato
e alluminio con finiture acciaio,
bianco, nero e tortora.

White aluminium frame.
Diffuser in double-coated methacrylate
and aluminium with steel, white,
black and dove grey finishes.
Not dimmable led light source.

DOHA A/P



Socket: **1 modulo LED**
Power: **max 15W**
Input: **220/240V**
Lumen: **1270Lm**
CRI: **>80**
Light temp.: **3000°K**
Pack: **0,013 m3**



DOHA A/G



Socket: **1 modulo LED**
Power: **max 25W**
Input: **220/240V**
Lumen: **2110Lm**
CRI: **>80**
Light temp.: **3000°K**
Pack: **0,027 m³**

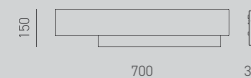

DOHA P/P



Socket: **2 moduli LED**
Power: **max 30W**
Input: **220/240V**
Lumen: **2620Lm**
CRI: **>80**
Light temp.: **3000°K**
Pack: **0,029 m³**

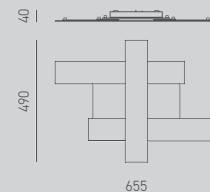

DOHA P/M



Socket: **2 moduli LED**
Power: **max 40W**
Input: **220/240V**
Lumen: **3750Lm**
CRI: **>80**
Light temp.: **3000°K**
Pack: **0,046 m³**

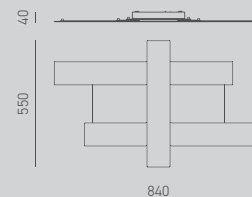





DOHA P/G

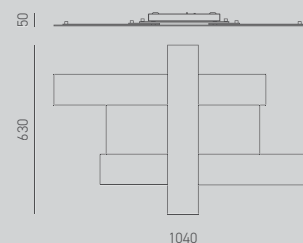

Socket: **2 moduli LED**
Power: **max 50W**
Input: **220/240V**
Lumen: **4470Lm**
CRI: **>80**
Light temp.: **3000°K**
Pack: **0,080 m³**



FINISHING

-  Acciaio / Steel
-  Bianco / White
-  Nero / Black
-  Tortora / Dove grey

NEW

CHRISTINE

**L'eclisse indoor nell'eterno
gioco tra luce e ombra**
An indoor eclipse, the eternal
play between light and shadow



CHRISTINE

Plafoniere con montatura in alluminio satinato bianco. Diffusore in metacrilato bianco opale. Sorgente luminosa led non dimmerabile.

Ceiling lighting with satin white aluminium frame. White opal methacrylate diffuser. Not dimmable LED light source.

CHRISTINE P/P



Socket: **1 modulo LED**
 Power: **40W**
 input: **220/240V**
 Light temp.: **3000°K**
 CRI: **>80**
 Lumen: **2600Lm**
 Pack: **0,023 m³**

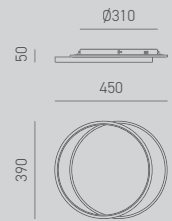

CHRISTINE P/G



Socket: **1 modulo LED**
 Power: **48W**
 input: **220/240V**
 Light temp.: **3000°K**
 CRI: **>80**
 Lumen: **3000Lm**
 Pack: **0,034 m³**

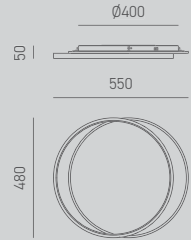

FINISHING

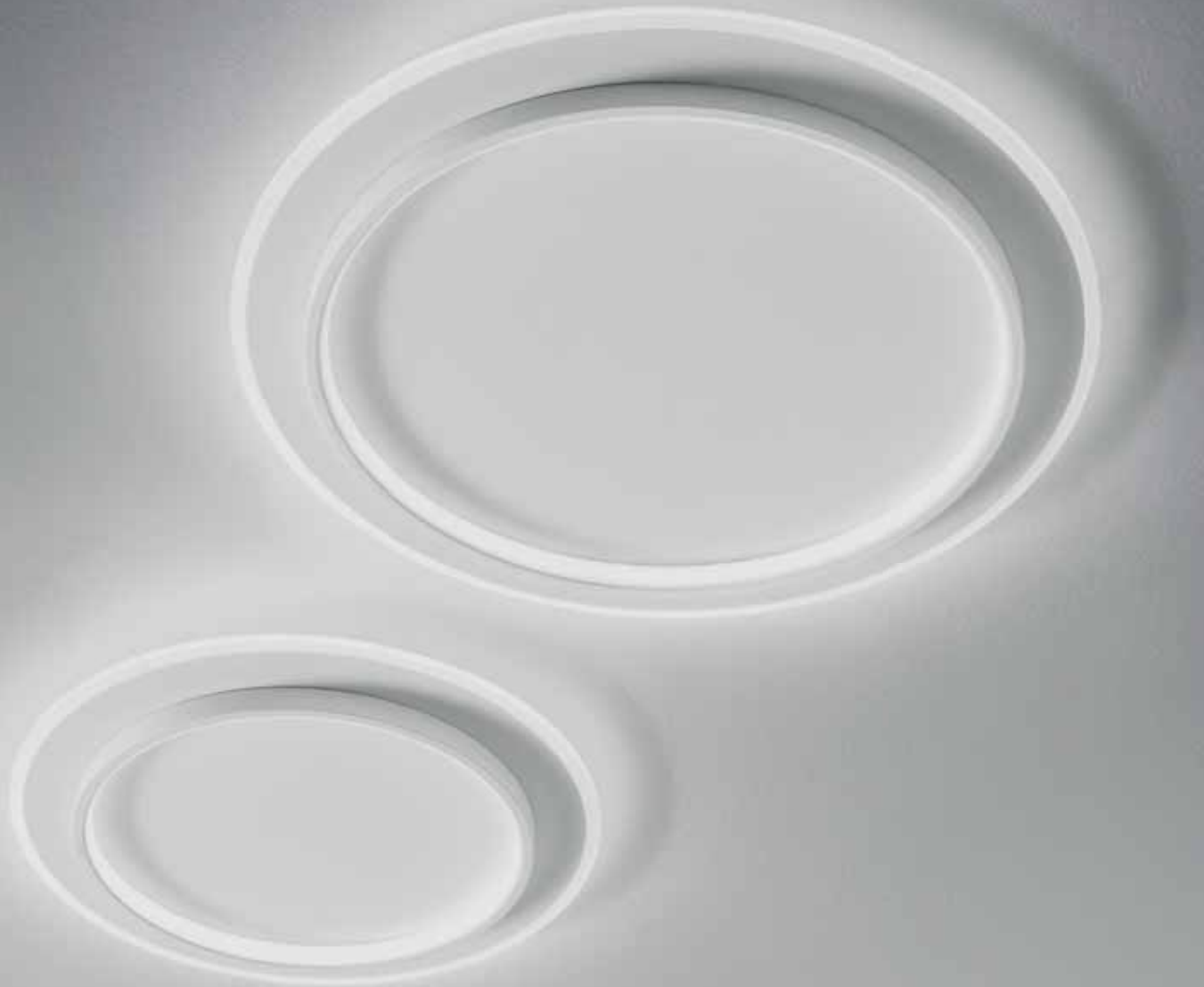

Bianco Satinato / Satin White

NEW**DHARMA**

Flat style, dove la luce è questione di spessore
Flat style, where light is a question of thickness

DHARMA

Plafoniere con montatura in alluminio satinato bianco. Diffusore in metacrilato bianco opale. Sorgente luminosa led non dimmerabile.

Ceiling lighting with satin white aluminium frame. White opal methacrylate diffuser. Not dimmable LED light source.



DHARMA P/P

Socket: **1 modulo LED**
 Power: **40W**
 input: **220/240V**
 Light temp.: **3000°K**
 CRI: **>80**
 Lumen: **2700Lm**
 Pack: **0,026 m³**

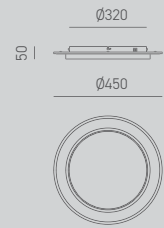

DHARMA P/G



Socket: **1 modulo LED**
 Power: **49W**
 input: **220/240V**
 Light temp.: **3000°K**
 CRI: **>80**
 Lumen: **3300Lm**
 Pack: **0,037 m³**



FINISHING



Bianco Satinato / Satin White

MELANIA



Quando ad illuminare è un nucleo vitale
A vibrant core of light





DUE SEMPLICI
CIRCONFERENZE
INSCRITTE L'UNA
NELL'ALTRA: MELANIA
RAPPRESENTA
UN'INTUIZIONE
STILISTICA IN GRADO
DI ARRICCHIRE DI
SIGNIFICATO E STILE
L'AMBIENTE CHE LA
ACCOGLIE.

MELANIA FEATURES
TWO SIMPLE
CIRCUMFERENCES
INSCRIBED ONE
INSIDE THE OTHER,
REPRESENTING A
STYLISTIC INTUITION
CAPABLE OF ENHANCING
ANY SPACE WITH
MEANING AND STYLE.

MELANIA

Montatura in alluminio verniciato bianco.
Diffusore in metacrilato satinato bianco.
Sorgente luminosa led non dimmerabile.

White painted aluminium frame.
Satin white methacrylate diffuser.
Not dimmable LED light source.



MELANIA P/P 3000°K

Socket: **2 moduli LED**
Power: **max 30W**
Input: **220/240V**
Lumen: **1300Lm**
CRI: **>80**
Light temp.: **3000°K**
Pack: **0,012 m³**

MELANIA P/P 4000°K

Socket: **2 moduli LED**
Power: **max 30W**
Input: **220/240V**
Lumen: **1600Lm**
CRI: **>80**
Light temp.: **4000°K**
Pack: **0,012 m³**



MELANIA P/M 3000°K

Socket: **2 moduli LED**
Power: **max 40W**
Input: **220/240V**
Lumen: **1700Lm**
CRI: **>80**
Light temp.: **3000°K**
Pack: **0,020 m³**

MELANIA P/M 4000°K

Socket: **2 moduli LED**
Power: **max 40W**
Input: **220/240V**
Lumen: **1820Lm**
CRI: **>80**
Light temp.: **4000°K**
Pack: **0,020 m³**



MELANIA P/G 3000°K

Socket: **2 moduli LED**
Power: **max 50W**
Input: **220/240V**
Lumen: **2100Lm**
CRI: **>80**
Light temp.: **3000°K**
Pack: **0,029 m³**

MELANIA P/G 4000°K

Socket: **2 moduli LED**
Power: **max 50W**
Input: **220/240V**
Lumen: **2260Lm**
CRI: **>80**
Light temp.: **4000°K**
Pack: **0,029 m³**

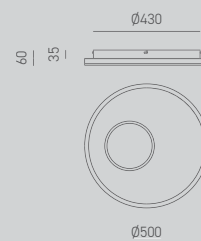

FINISHING



Bianco / White

AFRODITE

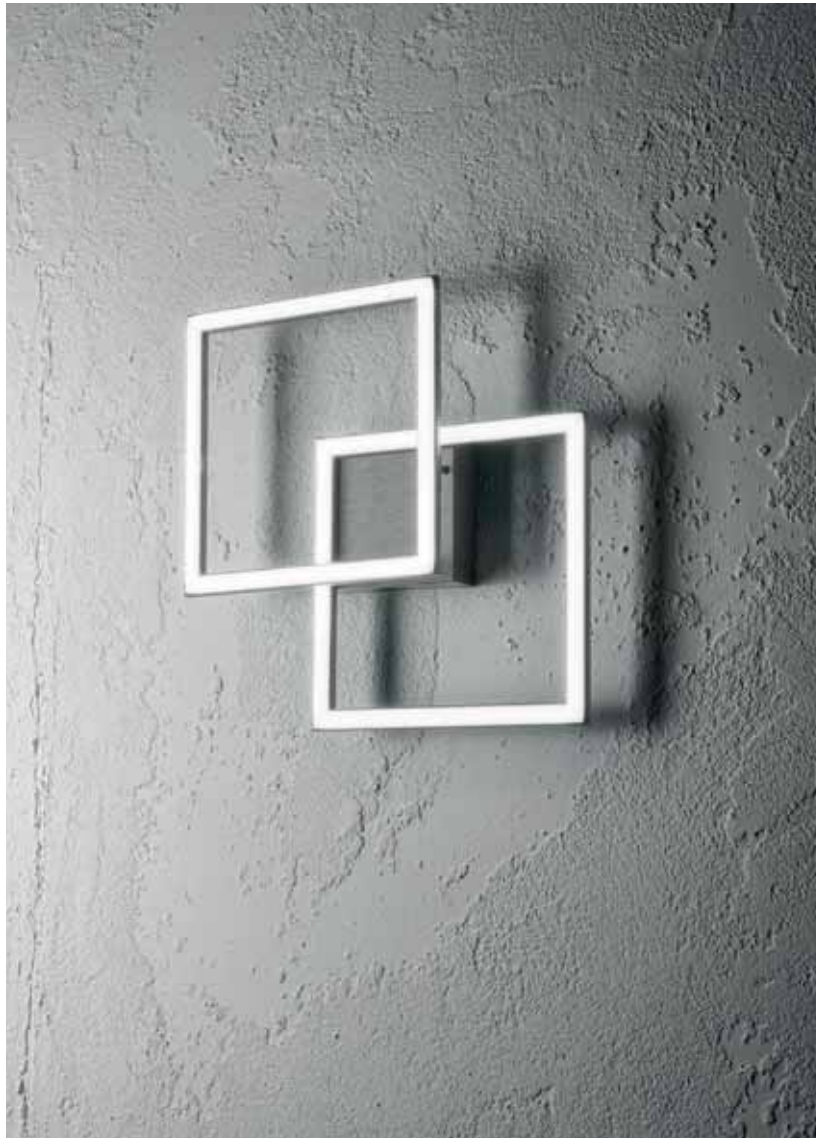

Un quadro di luminosa bellezza
A picture of glowing beauty

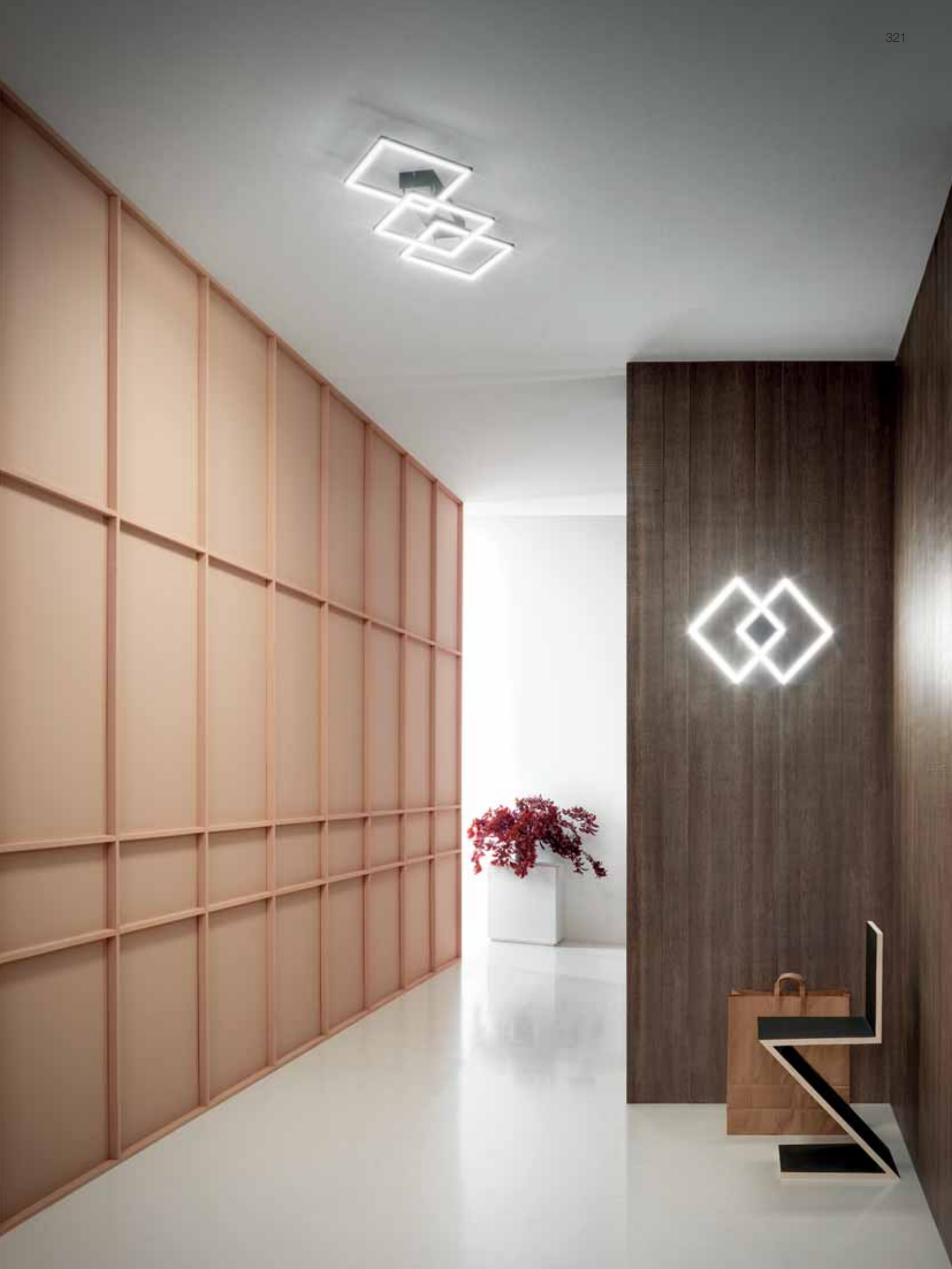

ESPRIME CON LA SUA ESSENZA, UNA GRANDE SEMPLICITÀ E LEGGEREZZA. UN DESIGN CHE VARIA IN BASE AL PUNTO DI VISTA. CON UN EFFETTO A ZIG-ZAG FLUIDO E LINEARE OPPURE, RUOTANDO DI 45° LA SUA INSTALLAZIONE, SI OTTENIE UNA CONFIGURAZIONE PIÙ INTIMA E COMPATTA.

ITS ESSENCE CONVEYS A STRIKING SIMPLICITY AND LIGHTNESS. A DESIGN THAT VARIES ACCORDING TO THE INSTALLATION APPROACH. CREATE A FLUID AND LINEAR ZIG-ZAG EFFECT OR - BY ROTATING ITS INSTALLATION BY 45° - A MORE INTIMATE AND COMPACT CONFIGURATION.



AFRODITE

Montatura in alluminio bianco satinato, oro spazzolato o titanio.
Diffusore in silicone bianco opale.
Sorgente luminosa led; dimmerabile tramite dimmer esterno + push (non inclusi).

Frame in satin white aluminum, brushed gold or titanium.
Opal white silicone diffuser.
LED light source; dimmable via external dimmer + push-button dimmer (not included).

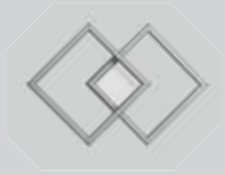

AFRODITE P/P

Socket: **2 moduli LED**
Power: **28W**
input: **220/240V**
Lumen: **1520Lm**
CRI: **>80**
Light temp.: **3000°K**
Pack: **0,021 m³**

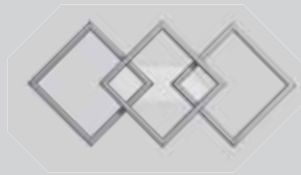
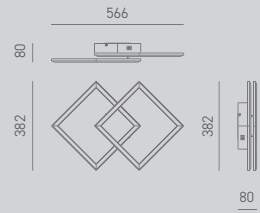

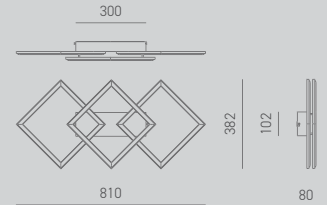

AFRODITE P/M

Socket: **3 moduli LED**
Power: **42W**
input: **220/240V**
Lumen: **2250Lm**
CRI: **>80**
Light temp.: **3000°K**
Pack: **0,04 m³**



FINISHING

-  Bianco Satinato / Satin White
-  Oro Spazzolato / Brushed Gold
-  Titanio / Titanium

TULLIA



**Minimal e dinamica, per una luce
che da spazio alla creatività**
Minimal and dynamic: lighting that gives
space to creativity





LA SUA PECULIARITÀ CONSISTE NEL POTER ORIENTARE GLI STELI CHE LA COMPONGONO, PERMETTENDOVÌ DI CREARE MOLTEPLICI CONFIGURAZIONI IN GRADO DI ARREDARE IL VOSTRO LIVING IN MODO SEMPRE DIFFERENTE.

WHAT MAKES THE TULLIA SERIES SPECIAL IS THAT YOU ARE ABLE TO DIRECT ITS STEMS, ALLOWING YOU TO CREATE MULTIPLE CONFIGURATIONS AND ILLUMINATE YOUR LIVING ROOM IN AN EVER-CHANGING WAY.

TULLIA

Plafoniere con montatura in alluminio satinato bianco. Diffusore in silicone bianco opale.
Sorgente luminosa led non dimmerabile.

Ceiling lighting with satin white aluminium frame. Opal white silicone diffuser.
Not dimmable LED light source.



TULLIA P/3 3000°K

Socket: **3 moduli LED**
Power: **30W**
Input: **220/240V**
Lumen: **1700Lm**
CRI: **>80**
Light temp.: **3000°K**
Pack: **0,019 m³**

TULLIA P/3 4000°K

Socket: **3 moduli LED**
Power: **30W**
Input: **220/240V**
Lumen: **1700Lm**
CRI: **>80**
Light temp.: **4000°K**
Pack: **0,019 m³**

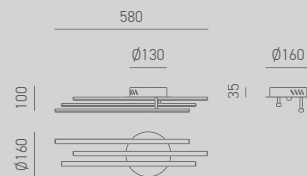

TULLIA P/4 3000°K

Socket: **4 moduli LED**
Power: **40W**
Input: **220/240V**
Lumen: **2200Lm**
CRI: **>80**
Light temp.: **3000°K**
Pack: **0,027 m³**

TULLIA P/4 4000°K

Socket: **4 moduli LED**
Power: **40W**
Input: **220/240V**
Lumen: **2200Lm**
CRI: **>80**
Light temp.: **4000°K**
Pack: **0,027 m³**

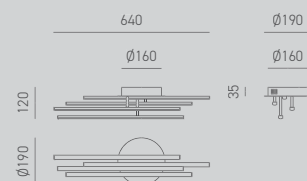

FINISHING



Bianco Satinato / Satin White

TESSA



Un intreccio di fili per illuminare con sinuosità
A web of threads for gently curving illumination



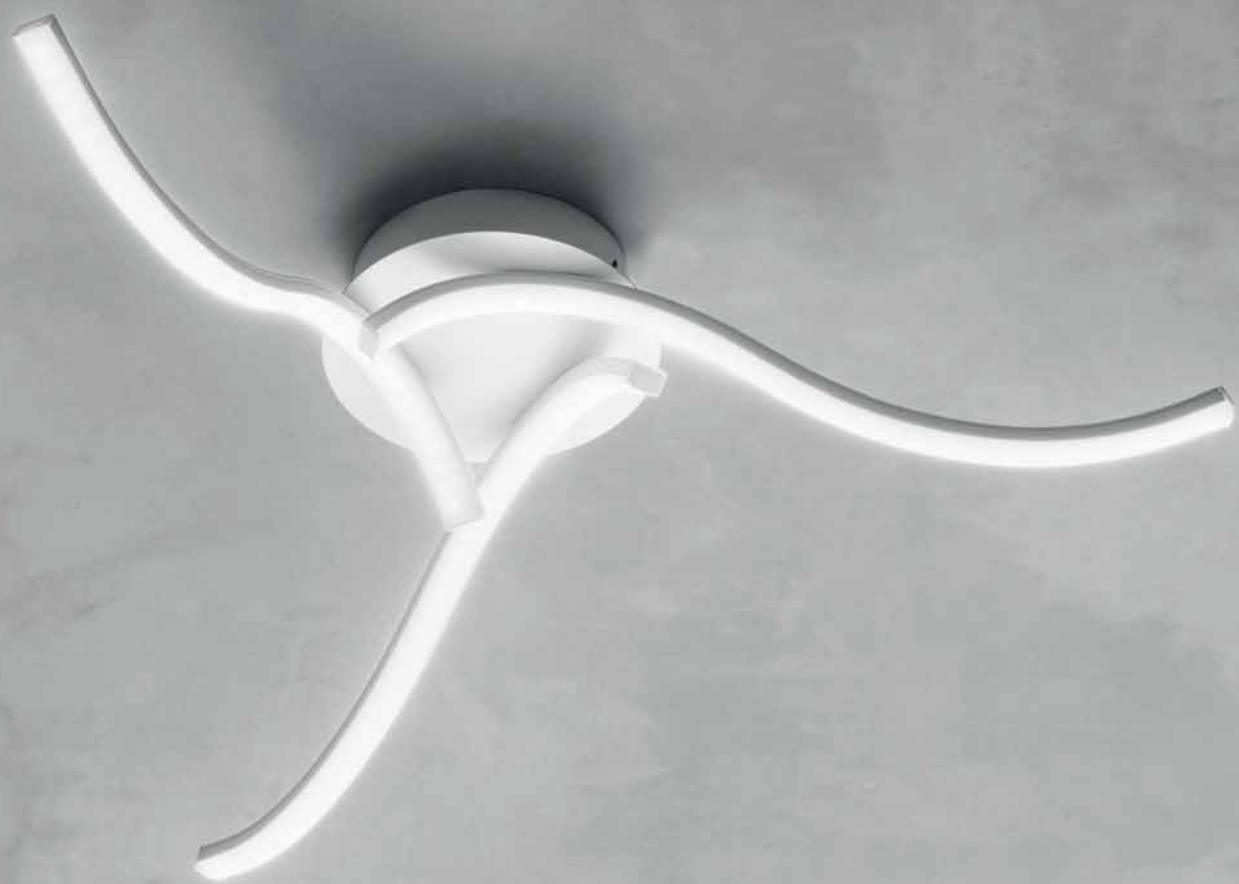

PERFETTA SINTESI
DI SEMPLICITÀ E
FUNZIONALITÀ, CON LE
SUE FATTEZZE SINUOSE
E MINIMALI TESSA
GENERA UN'ARMONIA
UNICA, PIACEVOLE E
RILASSANTE.

WITH ITS SINUOUS AND
MINIMALIST FEATURES,
TESSA GENERATES A
UNIQUE, PLEASANT AND
RELAXING HARMONY
THROUGH THE
PERFECT SYNTHESIS
OF SIMPLICITY AND
FUNCTIONALITY.

TESSA

Plafoniere con montatura in alluminio satinato bianco. Diffusore in silicone bianco opale.
Sorgente luminosa led non dimmerabile.

Ceiling lighting with satin white aluminium frame.
Opal white silicone diffuser.
Not dimmable LED light source.



TESSA P/3 3000°K

Socket: **3 moduli LED**
Power: **23W**
Input: **220/240V**
Lumen: **1300Lm**
CRI: **>80**
Light temp.: **3000°K**
Pack: **0,053 m³**

TESSA P/3 4000°K

Socket: **3 moduli LED**
Power: **23W**
Input: **220/240V**
Lumen: **1300Lm**
CRI: **>80**
Light temp.: **4000°K**
Pack: **0,053 m³**

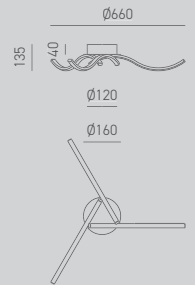

TESSA P/5 3000°K

Socket: **5 moduli LED**
Power: **38W**
Input: **220/240V**
Lumen: **2300Lm**
CRI: **>80**
Light temp.: **3000°K**
Pack: **0,074 m³**

TESSA P/5 4000°K

Socket: **5 moduli LED**
Power: **38W**
Input: **220/240V**
Lumen: **2300Lm**
CRI: **>80**
Light temp.: **4000°K**
Pack: **0,074 m³**

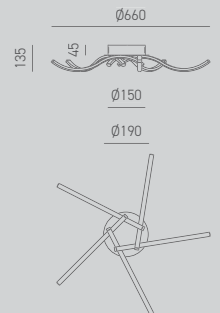

FINISHING



Bianco Satinato / Satin White

TOSCA

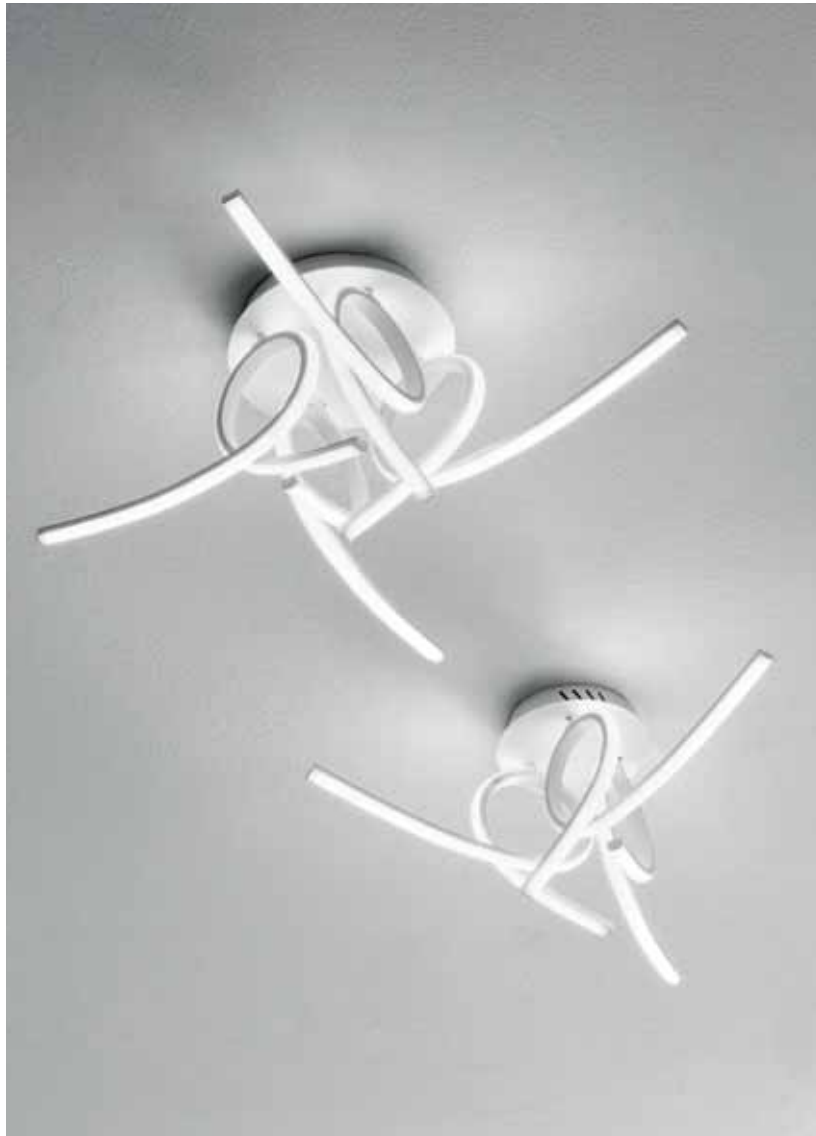

Un accento di design per dare carattere all'ambiente
A design accent that adds character to the space





TOSCA

Plafoniere con montatura
in alluminio satinato bianco.
Diffusore in silicone bianco opale.
Sorgente luminosa led non dimmerabile.

Ceiling lighting with satin white
aluminium frame.
Opal white silicone diffuser.
Not dimmable LED light source.



TOSCA P/1 3000°K

Socket: **1 modulo LED**
Power: **15W**
Input: **220/240V**
Lumen: **840Lm**
CRI: **>80**
Light temp.: **3000°K**
Pack: **0,024 m³**

TOSCA P/1 4000°K

Socket: **1 modulo LED**
Power: **15W**
Input: **220/240V**
Lumen: **840Lm**
CRI: **>80**
Light temp.: **4000°K**
Pack: **0,024 m³**

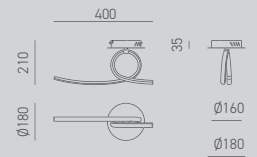

TOSCA P/3 3000°K

Socket: **3 moduli LED**
Power: **45W**
Input: **220/240V**
Lumen: **2500Lm**
CRI: **>80**
Light temp.: **3000°K**
Pack: **0,059 m³**

TOSCA P/3 4000°K

Socket: **3 moduli LED**
Power: **45W**
Input: **220/240V**
Lumen: **2500Lm**
CRI: **>80**
Light temp.: **4000°K**
Pack: **0,059 m³**

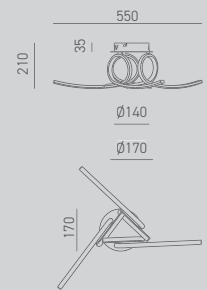

TOSCA P/4 3000°K

Socket: **4 moduli LED**
Power: **60W**
Input: **220/240V**
Lumen: **3200Lm**
CRI: **>80**
Light temp.: **3000°K**
Pack: **0,049 m³**

TOSCA P/4 4000°K

Socket: **4 moduli LED**
Power: **60W**
Input: **220/240V**
Lumen: **3200Lm**
CRI: **>80**
Light temp.: **4000°K**
Pack: **0,049 m³**

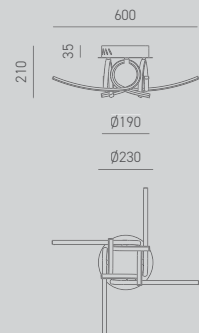

FINISHING



Bianco Satinato / Satin White

POINT



**Al centro della scena, l'essenziale che arreda
Taking centre stage, a minimalist design feature**

POINT

Plafone dotato di accessori per il fissaggio. Portalampade E27. Lampadina non inclusa.
 Finiture: Bianco satinato; Nero satinato; Ottone; Rame; Nickel satinato; Grigio cemento.

Ceiling lamp equipped with fitting accessories.
 Lampholder E27. Bulb not included.
 Available finishes: satin white; satin black; brass; copper; satin nickel; concrete grey.









- GSOP01** Bianco Satinato/Sand White
- GSOP02** Nero Satinato/Sand Black
- GSOP03** Ottone/Brass
- GSOP04** Rame/Copper
- GSOP05** Nickel Satinato/Satin Nickel
- GSOP06** Grigio Cemento/Concrete Grey



Socket: **1xE27**
 Power: **max 40W**
 input: **220/240V**
 Pack: **0,0016 m³**

FINISHING

-  Bianco Satinato / Satin White
-  Nero Satinato / Satin Black
-  Ottone / Brass
-  Rame / Copper
-  Nickel Satinato / Satin Nickel
-  Grigio Cemento / Concrete Grey



STEP



L'unità base per creare composizioni di luce riflessa
Base for creating reflected light compositions



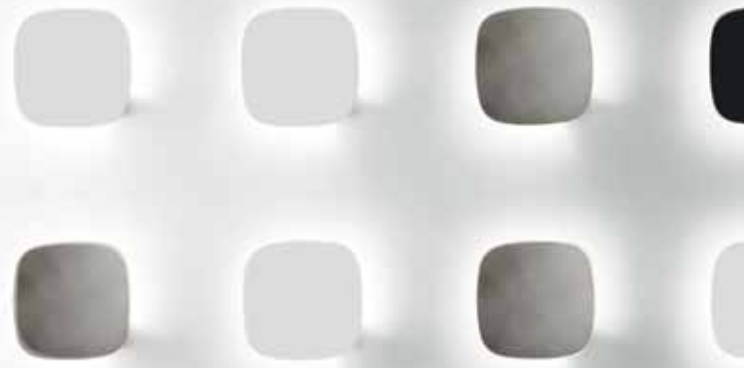





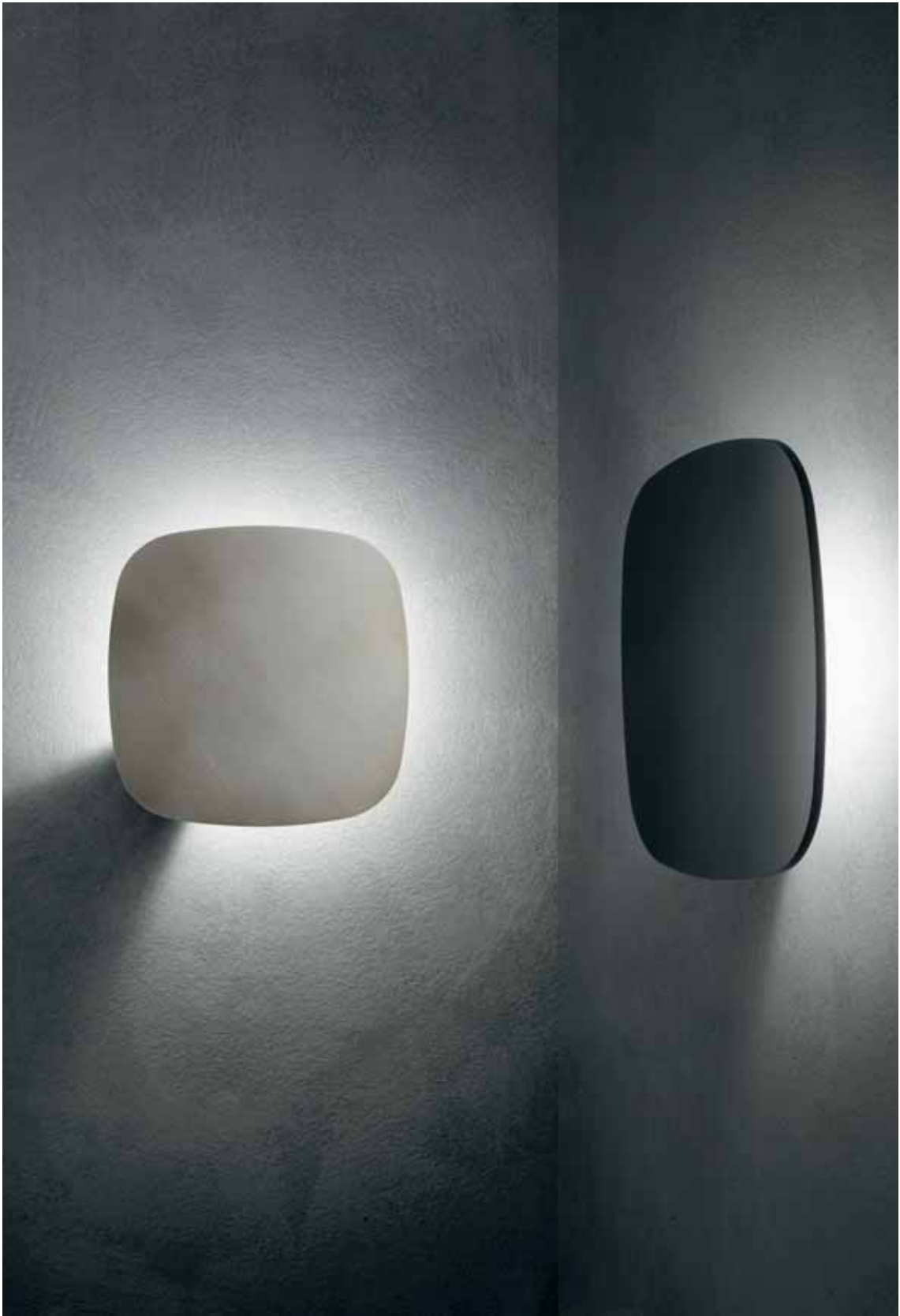





ESSENZIALITÀ E
MODULARITÀ SE BEN
MISCELATE SANNO DARE
UNO STILE UNICO. STEP
È DISPONIBILE COME
APPLIQUE SINGOLO O
DOPPIO E SI PRESTA A
TANTE COMBINAZIONI.

SIMPLICITY AND
MODULARITY, IF
MIXED CORRECTLY,
CAN PRODUCE A
UNIQUE STYLE. STEP
IS AVAILABLE AS A
SINGLE OR DOUBLE
WALL LIGHT AND LENDS
ITSELF TO A VARIETY OF
COMBINATIONS.

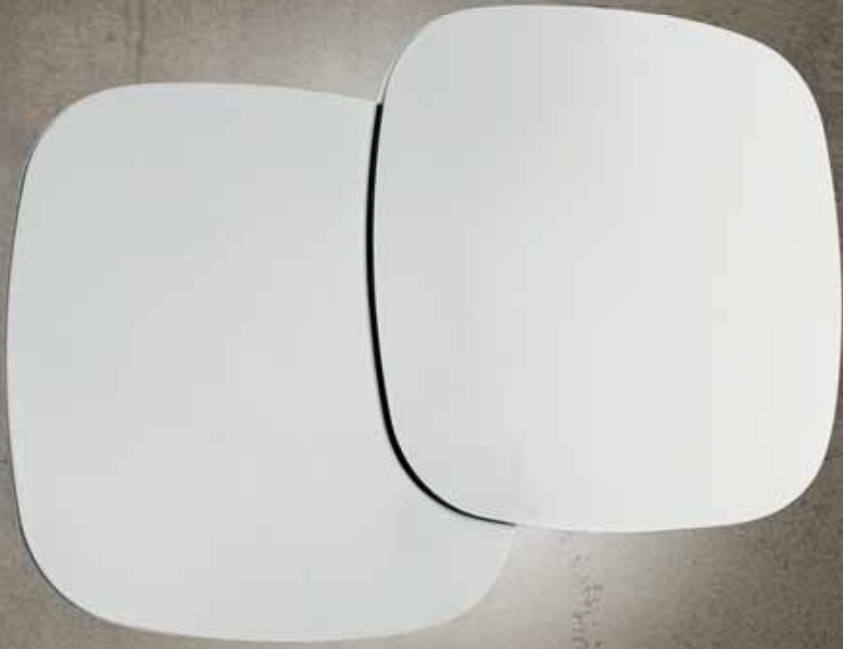

STEP

Lampada con struttura in alluminio, diffusore in metacrilato.
Disponibile nei colori bianco opaco, nero opaco ed anticato acciaio.
Sorgente luminosa COB LED dimmerabile a taglio di fase tramite dimmer esterno + push (non inclusi). Illuminazione indiretta.

Lamp with aluminium structure and metacrylate diffuser.
Available in matt white, matt black and antique steel.
Phase cut dimmable COB LED light source via external dimmer + push (not included). Indirect illumination.

STEP A/P



Socket: **1 COB LED**
Power: **20W**
input: **220/240V**
Lumen: **1800Lm**
CRI: **>80**
Light temp.: **3000°K**
Pack: **0,013 m³**



STEP A/G



Socket: **2 COB LED**
Power: **2x20W=40W**
input: **220/240V**
Lumen: **3600Lm**
CRI: **>80**
Light temp.: **3000°K**
Pack: **0,018 m³**

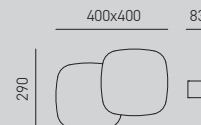

STEP P/P



Socket: **3 COB LED**
Power: **3x15W=45W**
input: **220/240V**
Lumen: **4050Lm**
CRI: **>80**
Light temp.: **3000°K**
Pack: **0,066 m³**

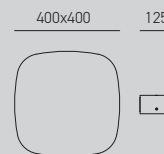



STEP P/M

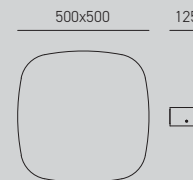

Socket: **3 COB LED**
Power: **3x20W=60W**
input: **220/240V**
Lumen: **5400Lm**
CRI: **>80**
Light temp.: **3000°K**
Pack: **0,065 m³**



FINISHING

-  Bianco opaco / Matt white
-  Nero opaco / Matt black
-  Acciaio anticato / Antique steel

PIXEL

Spazio alla digital light.
Make way for digital light.



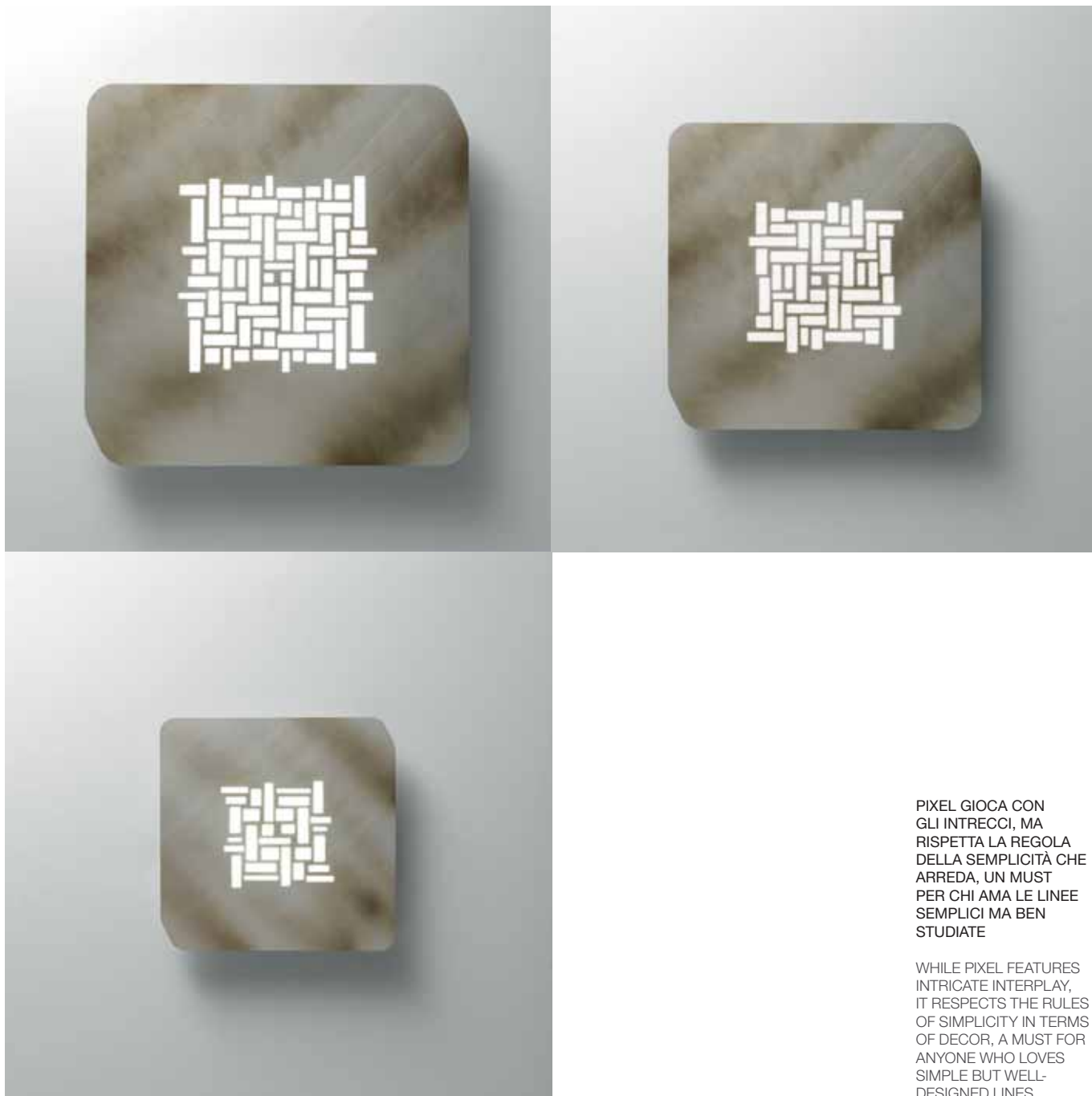

PIXEL GIOCA CON
GLI INTRECCI, MA
RISPETTA LA REGOLA
DELLA SEMPLICITÀ CHE
ARREDA, UN MUST
PER CHI AMA LE LINEE
SEMPLICI MA BEN
STUDIATE

WHILE PIXEL FEATURES
INTRICATE INTERPLAY,
IT RESPECTS THE RULES
OF SIMPLICITY IN TERMS
OF DECOR, A MUST FOR
ANYONE WHO LOVES
SIMPLE BUT WELL-
DESIGNED LINES.

PIXEL

Lampada con struttura in alluminio, e diffusore in metacrilato.
Disponibile nei colori bianco opaco, nero opaco ed anticato acciaio.
Sorgente luminosa LED dimmerabile.
A taglio di fase tramite dimmer esterno+push (non inclusi).
Illuminazione diretta.

Lamp with aluminium structure and metacrylate diffuser.
Available in matt white, matt black and antique steel.
Phase cut dimmable led light source via external dimmer+push (not included).
Direct illumination.



PIXEL P/P

Socket: **1 modulo LED**
Power: **25W**
input: **220/240V**
Lumen: **2500lm**
CRI: **>80**
Light temp.: **3000°K**
Pack: **0,031 m³**



PIXEL P/M

Socket: **1 modulo LED**
Power: **39W**
input: **220/240V**
Lumen: **3900lm**
CRI: **>80**
Light temp.: **3000°K**
Pack: **0,042 m³**

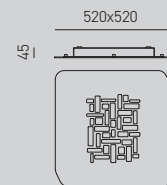

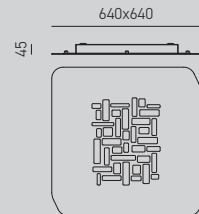

PIXEL P/G

Socket: **1 modulo LED**
Power: **56W**
input: **220/240V**
Lumen: **5600lm**
CRI: **>80**
Light temp.: **3000°K**
Pack: **0,060 m³**



FINISHING

-  Bianco opaco / Matt white
-  Nero opaco / Matt black
-  Acciaio anticato / Antique steel

BILDE



Le opere d'arte vivono di luce propria
Works of art live by their own light



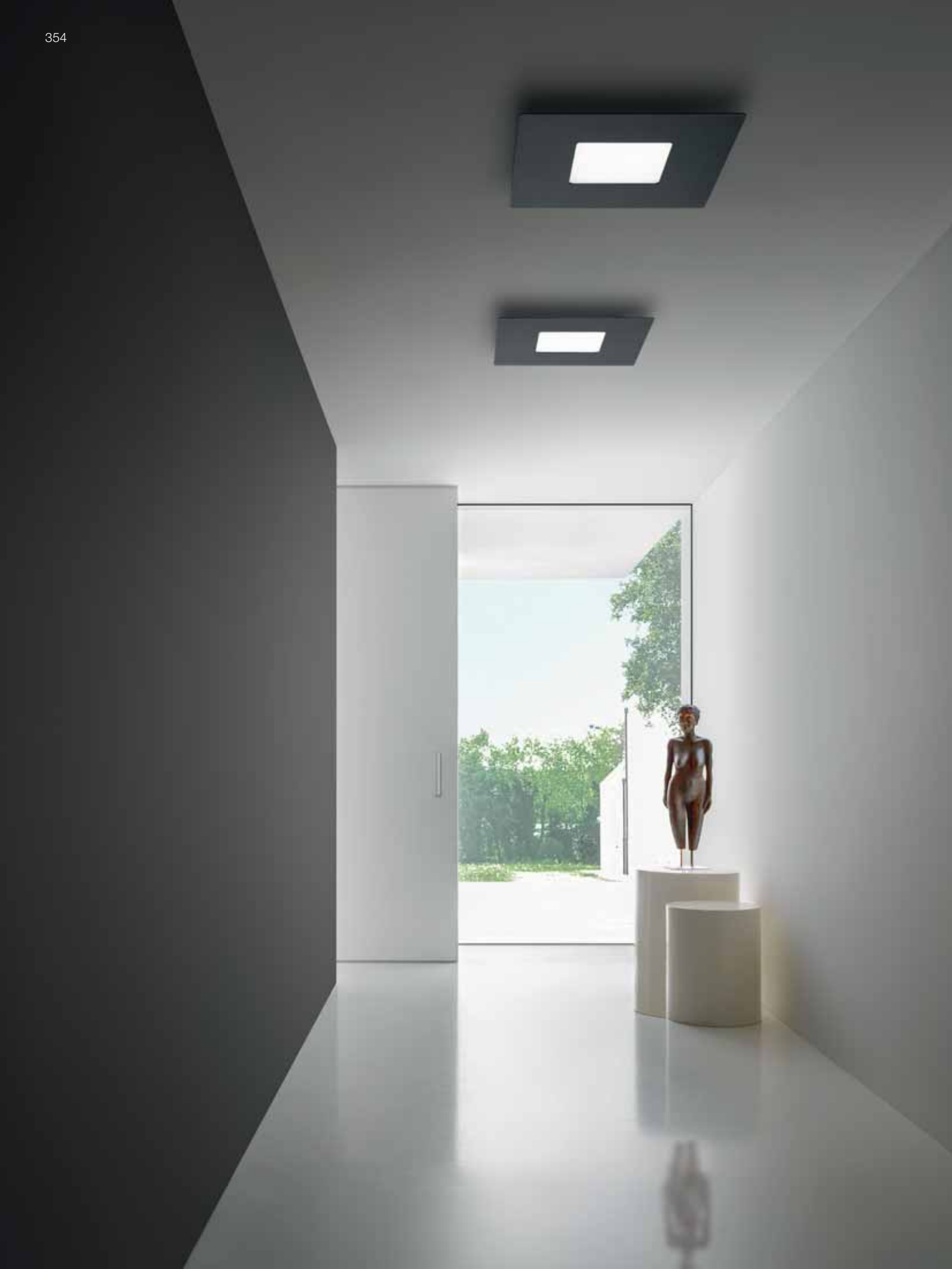

BILDE

Lampada con struttura in alluminio, diffusore in metacrilato.
Disponibile nei colori bianco opaco, nero opaco ed oro opaco.
Sorgente luminosa LED dimmerabile a taglio di fase tramite dimmer esterno+push (non inclusi). Illuminazione diretta.

Lamp with aluminium structure and metacrylate diffuser.
Available in matt white, matt black and matt gold.
Phase cut dimmable led light source via external dimmer+push (not included). Direct illumination.



BILDE P/P

Socket: **1 modulo LED**
Power: **25W**
input: **220/240V**
Lumen: **2500lm**
CRI: **>80**
Light temp.: **3000°K**
Pack: **0,031 m³**

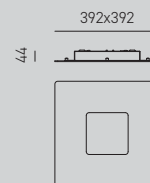

BILDE P/M

Socket: **1 modulo LED**
Power: **39W**
input: **220/240V**
Lumen: **3900lm**
CRI: **>80**
Light temp.: **3000°K**
Pack: **0,042 m³**

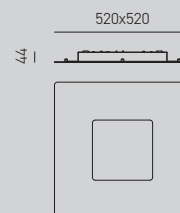

BILDE P/G

Socket: **1 modulo LED**
Power: **56W**
input: **220/240V**
Lumen: **5600lm**
CRI: **>80**
Light temp.: **3000°K**
Pack: **0,060 m³**

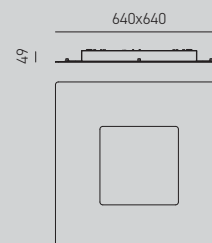

FINISHING

-  Bianco opaco / Matt white
-  Nero opaco / Matt black
-  Oro opaco / Matt gold

BILBAO



Briose geometrie per ambienti giovani
Vibrant shapes for youthful settings





BILBAO

Montatura in metallo bianco.
Diffusore in metacrilato
e alluminio con finiture acciaio, bianco
e tortora. Lampadine non incluse.

White painted metal fitting.
Methacrylate and aluminium diffuser
with steel, white and dove grey finishes.
Bulbs not included.



BILBAO P/P

Socket: **4xGx53**
Power: **max 4x8W**
Input: **220/240V**
Pack: **0,025 m³**

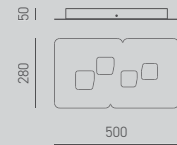

BILBAO P/M

Socket: **6xGx53**
Power: **max 6x8W**
Input: **220/240V**
Pack: **0,041 m³**

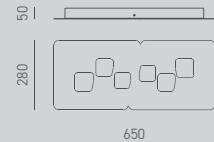

BILBAO P/G

Socket: **8xGx53**
Power: **max 8x8W**
Input: **220/240V**
Pack: **0,035 m³**

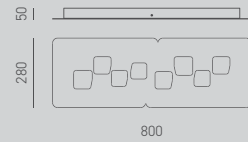

FINISHING

-  Acciaio / Steel
-  Bianco / White
-  Tortora / Dove grey

GISELLE



**La forma ancestrale del quadrato sposa
il dinamismo contemporaneo**
The ancestral square meets contemporary dynamism



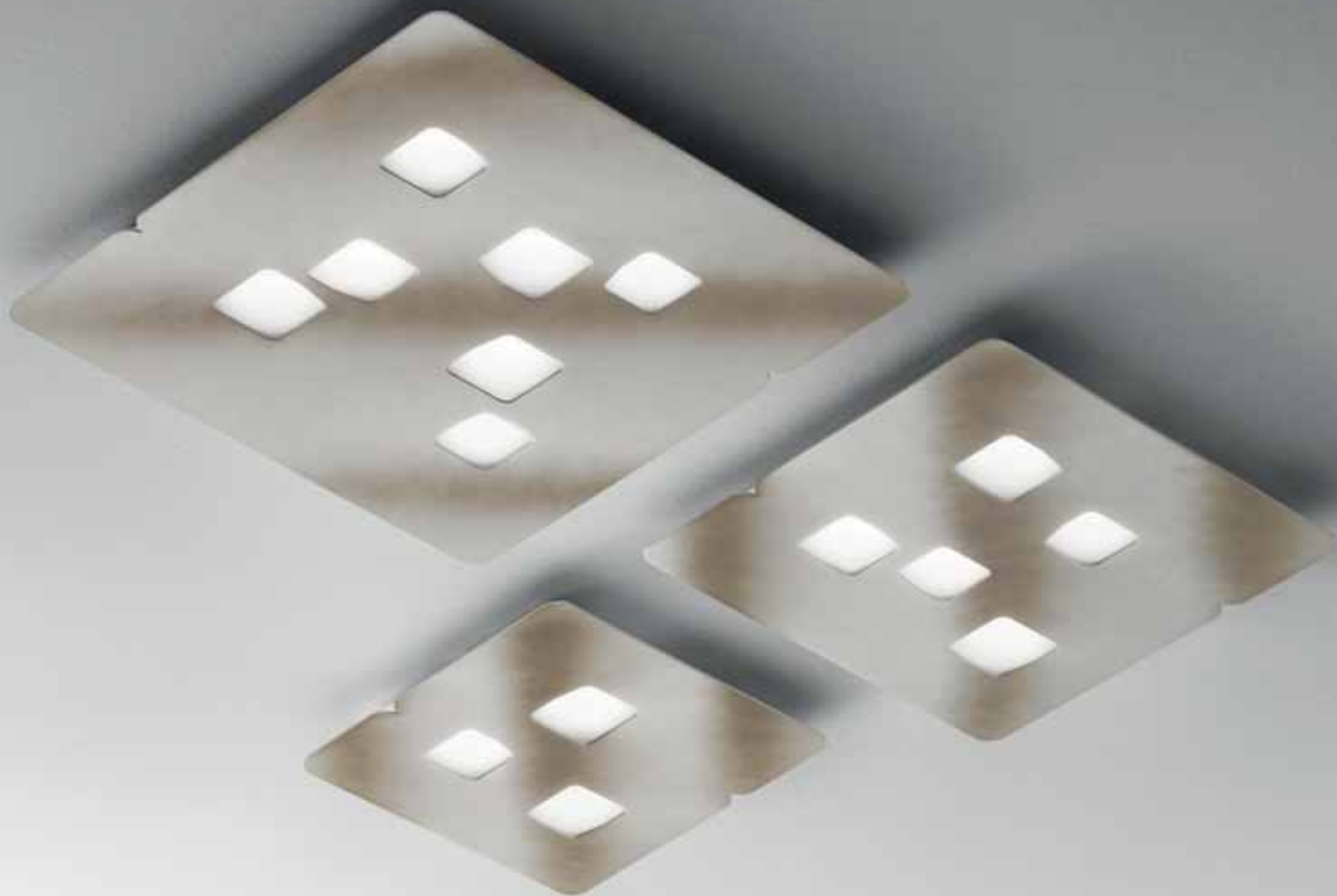

TASSELLI LUMINOSI
DISPOSTI
APPARENTEMENTE IN
MODO CASUALE SULLA
SUPERFICIE CREANO
ELEMENTI AGGRAZIATI...

LUMINOUS PIECES,
SEEMINGLY ARRANGED
AT RANDOM ON THE
SURFACE CREATE
GRACEFUL ELEMENTS...

GISELLE

Montatura in metallo bianco.
Diffusore in metacrilato e alluminio con finiture acciaio, bianco e tortora.
Sospensione con luce in biemissione.
Rosone bianco per finiture bianco e tortora.
Rosone in tinta per finiture acciaio.
Lampadine non incluse.

White metal frame.
Diffuser in methacrylate and aluminium with steel, white and dove grey finishes.
Suspension with two light sources.
White canopy for white and dove grey finishes. Matching canopy for steel finishes.
Bulbs not included.



GISELLE P/P

Socket: **3xGx53**
Power: **max 3x8W**
Input: **220/240V**
Pack: **0,024 m³**

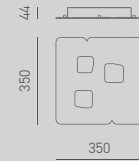

GISELLE P/M

Socket: **5xGx53**
Power: **max 5x8W**
Input: **220/240V**
Pack: **0,040 m³**

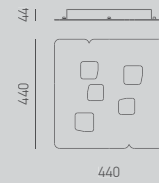

GISELLE P/G

Socket: **7xGx53**
Power: **max 7x8W**
Input: **220/240V**
Pack: **0,054 m³**

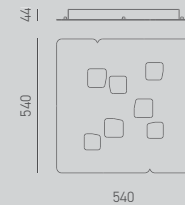

GISELLE S

Socket: **3xGx53 up**
7xGx53 down
Power: **max 3x8W up**
max 7x8W down
Input: **220/240V**
Pack: **0,054 m³**

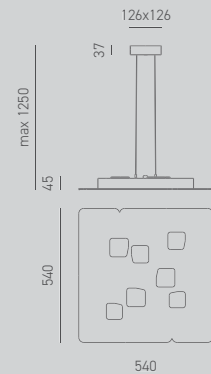

FINISHING

-  **Acciaio / Steel**
-  **Bianco / White**
-  **Tortora / Dove grey**

Nel riquadro sono raffigurati il nuovo sistema di aggancio delle plafoniere ed il sistema di biemissione delle sospensioni.

In detail are shown the hooking system of the ceiling lights and the bi-emission system of the suspensions.

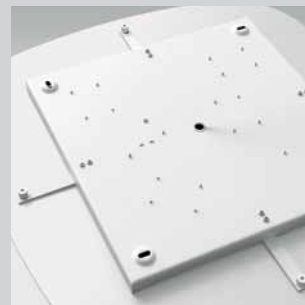

ISOTTA

**Un quadrato con effetto stretch,
per un tocco sorprendente**

**A square with a stretch effect,
for a surprising touch**

**Pulizia e funzionalità garantite dalla doppia emissione nella versione a sospensione,
mentre la soluzione a soffitto caratterizza gli spazi per la sua adattabilità.**

Isotta's suspended lamp version guarantees cleanliness and functionality with its double emission,
while the adaptability of the ceiling solution characterises any space.





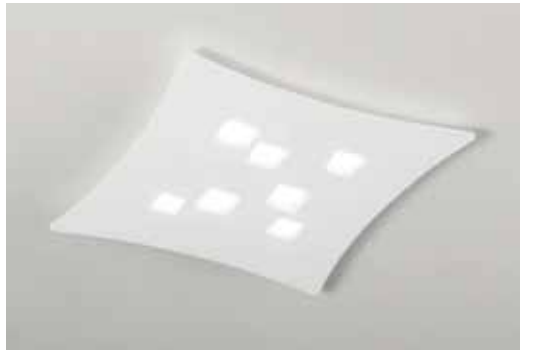



ISOTTA

Montatura in metallo bianco.
Diffusore in metacrilato
e alluminio con finiture bianco e tortora.
Sospensione con luce in biemissione.
Lampadine non incluse.

White painted metal fitting.
Methacrylate and aluminium diffuser
with white and dove grey finish.
Suspension with light in biemission.
Bulbs not included.



ISOTTA P/P

Socket: **3xGx53**
Power: **max 3x8W**
Input: **220/240V**
Pack: **0,033 m³**

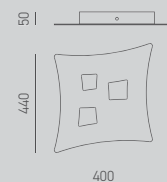

ISOTTA P/M

Socket: **5xGx53**
Power: **max 5x8W**
Input: **220/240V**
Pack: **0,050 m³**

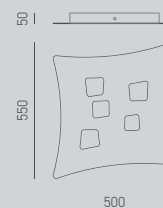

ISOTTA P/G

Socket: **7xGx53**
Power: **max 7x8W**
Input: **220/240V**
Pack: **0,070 m³**

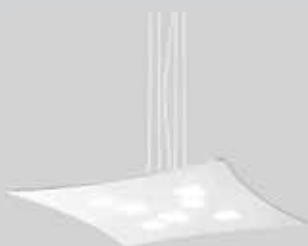
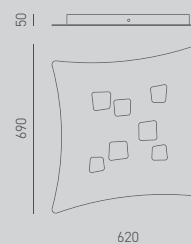

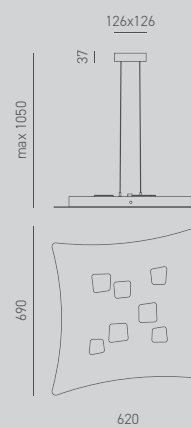

ISOTTA S

Socket: **3xGx53 up**
7xGx53 down
Power: **max 3x8W up**
max 7x8W down
Input: **220/240V**
Pack: **0,070 m³**



FINISHING

-  Bianco / White
-  Tortora / Dove grey

Nel dettaglio
è raffigurato il sistema
di biemissione
delle sospensioni

In detail is shown
the bi-emission system
of the suspensions.



LUNA



Moderna e minimal ma dai tratti sempre romantici
Modern, minimal but still romantic









LUNA

Montatura in metallo bianco.
Diffusore in metacrilato
e alluminio con finiture bianco e tortora.
Sospensione con luce in biemissione.
Lampadine non incluse.

White painted metal fitting.
Methacrylate and aluminium diffuser with
white and dove grey finish.
Suspension with light in biemission.
Bulbs not included.

LUNA P/P



Socket: **3xGx53**
Power: **max 3x8W**
Input: **220/240V**
Pack: **0,037 m³**

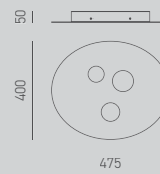

LUNA P/M



Socket: **5xGx53**
Power: **max 5x8W**
Input: **220/240V**
Pack: **0,050 m³**

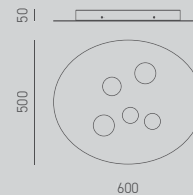

LUNA P/G



Socket: **7xGx53**
Power: **max 7x8W**
Input: **220/240V**
Pack: **0,070 m³**

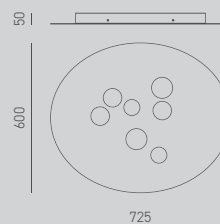

LUNA S



Socket: **3xGx53 up**
7xGx53 down
Power: **max 3x8W up**
max 7x8W down
Input: **220/240V**
Pack: **0,070 m³**

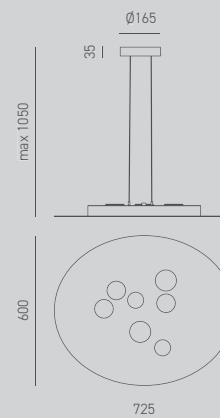

FINISHING

-  Bianco / White
-  Tortora / Dove grey

Nel dettaglio
è raffigurato il sistema
di biemissione
delle sospensioni

In detail is shown
the bi-emission system
of the suspensions.





NEW

GAP ARCO

**Biemissione a parete dal
sapore istituzionale**
Two-way wall light with an
institutional mood

GAP ARCO

Struttura in alluminio bianco satinato.
Diffusore in acrilico bianco opaco.
Modulo LED non dimmerabile e
trasformatore inclusi.

White satin-finish aluminium frame.
Matte white acrylic diffuser.
Not dimmable LED module and
transformer included.



GAP500C

GAP500N

Socket:	1 modulo LED	1 modulo LED
Power:	16W	16W
input:	220/240V	220/240V
Light temp.:	3000°K	4000°K
CRI:	>80	>80
Lumen:	1664Lm	1710Lm
Pack:	0,002 m³	0,002 m³
Beam Angle:	120°	120°
IP:	20	20



GAP501C

GAP501N

Socket:	1 modulo LED	1 modulo LED
Power:	20W	20W
input:	220/240V	220/240V
Light temp.:	3000°K	4000°K
CRI:	>80	>80
Lumen:	2107Lm	2221Lm
Pack:	0,003 m³	0,003 m³
Beam Angle:	120°	120°
IP:	20	20

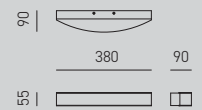

FINISHING



Bianco Satinato / Satin White

NEW

GAP LINEA



Rigore minimalista per una luce d'ambiente funzionale
Minimalist rigour for functional ambient lighting

GAP LINEA

Struttura in alluminio bianco satinato.
Diffusore in acrilico bianco opaco.
Modulo LED non dimmerabile
e trasformatore inclusi.

White satin-finish aluminium frame.
Matte white acrylic diffuser.
Not dimmable LED module and
transformer included.

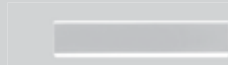

	GAP510C	GAP510N
Socket:	1 modulo LED	1 modulo LED
Power:	16W	16W
input:	220/240V	220/240V
Light temp.:	3000°K	4000°K
CRI:	>80	>80
Lumen:	1778Lm	1899Lm
Pack:	0,002 m³	0,002 m³
Beam Angle:	120°	120°
IP:	20	20

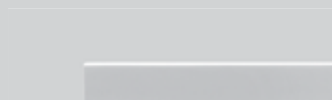

	GAP511C	GAP511N
Socket:	1 modulo LED	1 modulo LED
Power:	24W	24W
input:	220/240V	220/240V
Light temp.:	3000°K	4000°K
CRI:	>80	>80
Lumen:	2601Lm	2859Lm
Pack:	0,003 m³	0,002 m³
Beam Angle:	120°	120°
IP:	20	20



FINISHING



Bianco Satinato / Satin White

POLAR

**Luce pura, nessuna distrazione
per la massima funzionalità**
Pure light with no distractions,
for maximum functionality



UN FORMA EASY,
SOBRIA, PERFETTA
CHE BEN SI CONIUGA
CON QUALUNQUE
STILE ED AMBIENTE,
RICHIESTISSIMA SIA
DAL PRIVATO COME DAL
MONDO CONTRACT.

AN EASY, SOBER,
PERFECT SHAPE THAT
BLENDS
WELL WITH ANY STYLE
AND ENVIRONMENT,
HIGHLY SOUGHT AFTER
BY BOTH THE PRIVATE
AND THE CONTRACT
SECTORS.



POLAR

Struttura in alluminio IP44.
Diffusore in materiale plastico opale.
Finitura: bianco opaco o cromo.
Modulo LED non dimmerabile e trasformatore inclusi.

IP44 aluminium structure. Opal plastic diffuser. White or chrome finish. Not dimmable LED module and transformer included.

IP44



GAP480C Bianco / White
GAP481C Cromo / Chrome

Socket: **1 modulo LED**
Power: **7W**
input: **220/240V**
Light temp.: **3000°K**
Optic: **120°**
Lumen: **640Lm**
CRI: **>80**
IP: **44**
Pack: **0,0324 m³**



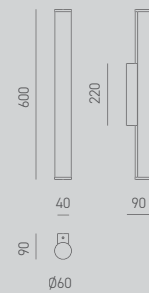

GAP482C Bianco / White
GAP483C Cromo / Chrome

Socket: **1 modulo LED**
Power: **14W**
input: **220/240V**
Light temp.: **3000°K**
Optic: **120°**
Lumen: **1350Lm**
CRI: **>80**
IP: **44**
Pack: **0,0016 m³**



FINISHING

 Bianco / White

 Cromo / Chrome

RING

Linee morbide e una luce senza compromessi
Soft lines and uncompromising light

Il suo nome già ci anticipa il carattere e la forma di questo oggetto d'illuminazione
che trova una sua collocazione sia da parete che da soffitto.

Its name already anticipates the character and shape of this lighting object,
which can be used both on the wall and on the ceiling.





RING

Struttura in alluminio IP44. Diffusore in materiale acrilico trasparente satinato.
Finitura: bianco opaco.
Modulo LED non dimmerabile e trasformatore inclusi.

IP44 aluminium structure.
Diffuser in transparent satin acrylic material.
Matt white finish.
Not dimmable LED module and transformer included.

IP44



GAP470C

Socket: **1 modulo LED**
Power: **12W**
input: **220/240V**
Light temp.: **3000°K**
Optic: **120°**
Lumen: **1260Lm**
Hours: **50.000**
CRI: **>80**
IP: **44**
Pack: **0,0043 m³**

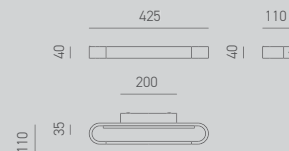

GAP470N

Socket: **1 modulo LED**
Power: **12W**
input: **220/240V**
Light temp.: **4000°K**
Optic: **120°**
Lumen: **1230Lm**
Hours: **50.000**
CRI: **>80**
IP: **44**
Pack: **0,0043 m³**

FINISHING



Bianco / White

MAGIS



Luce d'accento per esaltare la bellezza della vita
An accent light to enhance the beauty of life





PUÒ ESSERE
INSTALLATA IN
SOLAMENTE IN
AMBIENTI INTERNI ED
ASCIUTTI. E' IDEALE
COME APPLIQUE
E COME LAMPADA
DA QUADRO. IL
BRACCETTO DI PICCOLE
DIMENSIONI CONSENTE
UNA PICCOLA
ORIENTABILITÀ.

IT CAN ONLY BE
INSTALLED INDOORS AND
IN DRY ENVIRONMENTS.
IT IS IDEAL AS A WALL
LAMP AND AS A LAMP
FOR A PICTURE. THE
SMALL ARM ALLOWS A
SMALL ADJUSTABILITY.



MAGIS

Struttura in metallo.
Finitura in bianco opaco, cromo,
nickel satinato o brunito.
Diffusore in materiale sintetico.
Modulo LED non dimmerabile e
trasformatore inclusi.

Metal structure. Matt white,
chrome, satin or burnished nickel
finish. Synthetic diffuser,
Not dimmable LED module and
transformer included.



GAP440C Nickel Satinato / Satin Nickel

GAP441C Bianco Opale / Opal White

GAP442C Cromo / Chrome

GAP443C Brunito / Antique Brass

Power: **8W**
input: **220/240V**
Light temp.: **3000°K**
Optic: **120°**
Lumen: **473Lm**
Hours **50.000**
CRI: **>80**
IP: **20**
Pack: **0,0071 m³**

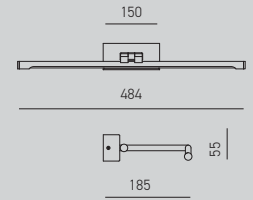

GAP440N Nickel Satinato / Satin Nickel

GAP441N Bianco Opale / Opal White

GAP442N Cromo / Chrome

GAP443N Brunito / Antique Brass

Power: **8W**
input: **220/240V**
Light temp.: **4000°K**
Optic: **120°**
Lumen: **451Lm**
Hours **50.000**
CRI: **>80**
IP: **20**
Pack: **0,0071 m³**

FINISHING

-  Nickel Satinato / Satin Nickel
-  Bianco Opale / Opal White
-  Cromo / Chrome
-  Brunito / Antique Brass

MAGIS

Struttura in metallo. Finitura in bianco opaco, cromo, nickel satinato o brunito. Diffusore in materiale sintetico. Modulo LED non dimmerabile e trasformatore inclusi.

Metal structure. Matt white, chrome, satin or burnished nickel finish. Synthetic diffuser. Not dimmable LED module and transformer included.



GAP450C Nickel Satinato / Satin Nickel

GAP451C Bianco Opale / Opal White

GAP452C Cromo / Chrome

GAP453C Brunito / Antique Brass

Power: **10W**
 input: **220/240V**
 Light temp.: **3000°K**
 Optic: **120°**
 Lumen: **580Lm**
 Hours: **50.000**
 CRI: **>80**
 IP: **20**
 Pack: **0,0085 m³**

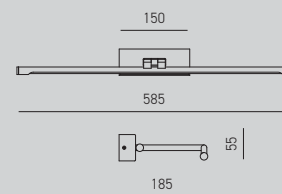

GAP450N Nickel Satinato / Satin Nickel

GAP451N Bianco Opale / Opal White

GAP452N Cromo / Chrome

GAP453N Brunito / Antique Brass

Power: **10W**
 input: **220/240V**
 Light temp.: **4000°K**
 Optic: **120°**
 Lumen: **525Lm**
 Hours: **50.000**
 CRI: **>80**
 IP: **20**
 Pack: **0,0085 m³**

FINISHING

-  Nickel Satinato / Satin Nickel
-  Bianco Opale / Opal White
-  Cromo / Chrome
-  Brunito / Antique Brass

MAGIS

Struttura in metallo. Finitura in bianco opaco, cromo, nickel satinato o brunito. Diffusore in materiale sintetico. Modulo LED non dimmerabile e trasformatore inclusi.

Metal structure. Matt white, chrome, satin or burnished nickel finish. Synthetic diffuser. Not dimmable LED module and transformer included.



GAP460C Nickel Satinato / Satin Nickel

GAP461C Bianco Opale / Opal White

GAP462C Cromo / Chrome

GAP463C Brunito / Antique Brass

Power: **12W**
 input: **220/240V**
 Light temp.: **3000°K**
 Optic: **120°**
 Lumen: **656Lm**
 Hours **50.000**
 CRI: **>80**
 IP: **20**
 Pack: **0,01 m³**

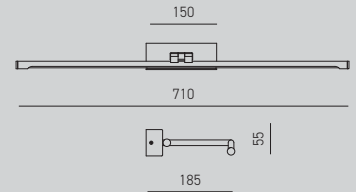

GAP460N Nickel Satinato / Satin Nickel

GAP461N Bianco Opale / Opal White

GAP462N Cromo / Chrome

GAP463N Brunito / Antique Brass

Power: **12W**
 input: **220/240V**
 Light temp.: **4000°K**
 Optic: **120°**
 Lumen: **591Lm**
 Hours **50.000**
 CRI: **>80**
 IP: **20**
 Pack: **0,01 m³**

FINISHING

-  Nickel Satinato / Satin Nickel
-  Bianco Opale / Opal White
-  Cromo / Chrome
-  Brunito / Antique Brass

ONE

**Pochi tratti ben definiti per un design
elegante e impeccabile**
Well-defined lines for an elegant,
impeccable design

Rigorosa nelle geometrie e versatile nell'utilizzo, adatta per l'illuminazione da quadro o come luce da bagno. Tecnicamente all'avanguardia ed esteticamente impeccabile.

Rigorous in its geometry and versatile in its use, suitable as lighting for a picture or as a bathroom light. Technologically advanced and aesthetically flawless.





ONE

Struttura in alluminio IP44.
Diffusore in materiale sintetico.
Finitura: bianco opaco o nero opaco.
Modulo LED non dimmerabile e trasformatore inclusi.

IP44 aluminium structure. Syntetic diffuser.
Matt white or matt black finish.
Not dimmable LED module and transformer included.

IP44

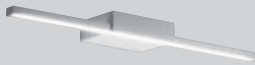

GAP490C Bianco Opaco / Matt White

GAP491C Nero Opaco / Matt Black

Socket: **1 modulo LED**
Power: **12W**
input: **220/240V**
Light temp.: **3000°K**
Optic: **120°**
Lumen: **870Lm**
CRI: **>80**
IP: **44**
Pack: **0,0034 m³**

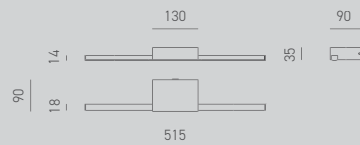

GAP492C Bianco Opaco / Matt White

GAP493C Nero Opaco / Matt Black

Socket: **1 modulo LED**
Power: **16W**
input: **220/240V**
Light temp.: **3000°K**
Optic: **120°**
Lumen: **1670Lm**
CRI: **>80**
IP: **44**
Pack: **0,0045 m³**

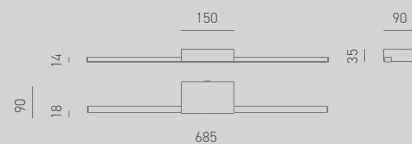

FINISHING



Bianco Opaco / Matt White



Nero Opaco / Matt Black





**LAMPADE
DA APPOGGIO
E DA TERRA**

NEKKAR

**Ispirato alla natura sempre
in mutamento**
Inspired by ever-changing
nature



NEKKAR

Lampada da tavolo in materiale sintetico con braccio flessibile in silicone. Interruttore ON/OFF con touch control dimmer sulla base. Modulo LED incluso. Finitura in bianco lucido, grigio lucido, nero lucido o celeste lucido.

Table lamp in synthetic material with flexible silicone arm. ON/OFF switch on the base with touch control for dimming mode. LED module included. Glossy white, glossy grey, glossy black or glossy light blue.



GLS020 Bianco Lucido/Glossy White

Power: **5W**
input: **220/240V**
Light temp.: **3000°K**
Lumen: **350Lm**
Hours **20.000**
CRI: **>80**
Pack: **0,0048 m³**

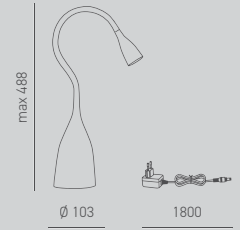

GLS021 Grigio Lucido/Glossy Grey

Power: **5W**
input: **220/240V**
Light temp.: **3000°K**
Lumen: **350Lm**
Hours **20.000**
CRI: **>80**
Pack: **0,0048 m³**

GLS022 Nero Lucido/Glossy Black

Power: **5W**
input: **220/240V**
Light temp.: **3000°K**
Lumen: **350Lm**
Hours **20.000**
CRI: **>80**
Pack: **0,0048 m³**

GLS023 Celeste Lucido/Glossy Light Blue

Power: **5W**
input: **220/240V**
Light temp.: **3000°K**
Lumen: **350Lm**
Hours **20.000**
CRI: **>80**
Pack: **0,0048 m³**

FINISHING

-  Bianco Lucido / Glossy White
-  Grigio Lucido / Glossy Grey
-  Nero Lucido / Glossy Black
-  Celeste Lucido / Glossy Light Blue



NUNKI



L'eleganza delle forme curve
The elegance of curves

NUNKI

Lampada da tavolo in materiale sintetico con braccio flessibile in silicone. Interruttore ON/OFF sulla base con touch control che consente tre modalità di dimmerazione. Modulo LED incluso. Finitura in bianco lucido, grigio lucido, oro satinato, nero opaco o rosso lucido.

Table lamp in synthetic material with flexible silicone arm. ON/OFF switch on the base with touch control for three dimming modes. LED module included. Glossy white, glossy grey, matt gold, matt black or glossy red finish.



GLS001 Nero Opaco/Matt Black

Power: **4,5W**
input: **220/240V**
Light temp.: **3000°K**
Lumen: **480Lm**
Hours **20.000**
CRI: **>80**
Pack: **0,0010 m³**

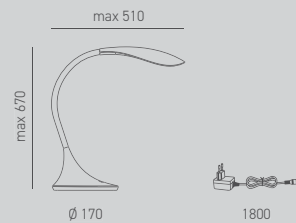

GLS002 Bianco Lucido/Glossy White

Power: **4,5W**
input: **220/240V**
Light temp.: **3000°K**
Lumen: **480Lm**
Hours **20.000**
CRI: **>80**
Pack: **0,0010 m³**

GLS003 Rosso Lucido/Glossy Red

Power: **4,5W**
input: **220/240V**
Light temp.: **3000°K**
Lumen: **480Lm**
Hours **20.000**
CRI: **>80**
Pack: **0,0010 m³**

GLS004 Grigio Lucido/Glossy Grey

Power: **4,5W**
input: **220/240V**
Light temp.: **3000°K**
Lumen: **480Lm**
Hours **20.000**
CRI: **>80**
Pack: **0,0010 m³**

GLS005 Oro Satinato/Matt Gold

Power: **4,5W**
input: **220/240V**
Light temp.: **3000°K**
Lumen: **480Lm**
Hours **20.000**
CRI: **>80**
Pack: **0,0010 m³**



FINISHING

-  Bianco Lucido / Glossy White
-  Grigio Lucido / Glossy Grey
-  Oro Satinato / Matt Gold
-  Nero Opaco / Matt Black
-  Rosso Lucido / Glossy Red

NICOLE



Essenzialità ed efficienza per uno stile pop
Pop-style efficiency and minimalist design





NICOLE

Montatura in alluminio bianco satinato, nero satinato, oro spazzolato o titanio.
Diffusore in silicone bianco opale.
Sorgente luminosa led; dimmerabile tramite dimmer integrato nel cablaggio.

Frame in satin white or satin black aluminium, brushed gold or titanium.
Opal white silicone diffuser.
LED light source with inline cord dimmer.



NICOLE L

Power: **12W**
input: **220/240V**
Lumen: **655Lm**
CRI: **>80**
Light temp.: **3000°K**
Pack: **0,023 m³**

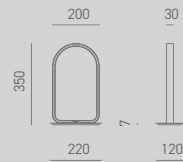

FINISHING

-  Bianco Satinato / Satin White
-  Oro Spazzolato / Brushed Gold
-  Nero Satinato / Satin Black
-  Titanio / Titanium

YPSILON

**Un design intramontabile che arreda con eleganza
ambienti sofisticati**

**A timeless, elegant design feature for sophisticated
settings**

YPSILON abbina stile e funzionalità, caratterizzando gli ambienti grazie alla sua luce indiretta che genera piacevolezza e confort visivo.

YPSILON combines style and functionality, giving a sense of character to the rooms thanks to its indirect light that generates pleasantness and visual comfort.





YPSILON

Piantana dimmerabile
con struttura in alluminio.
Finitura in bianco o nero opaco.
Diffusore in vetro.
Modulo LED e trasformatore incluso.
Illuminazione Up&Down.

Dimmable floor lamp with
aluminium structure.
White or black matt finish.
Satin glass diffuser.
LED module and transformer included.
Up&Down illumination.



GP1B10 Bianco Opaco / Matt White

Power UP: **48W**
Input: **220/240V**
Lumen: **3400Lm**
CRI: **>80**
Light temp.: **3000°K**
IP: **20**
Pack: **0,047 m³**



GP1N10 Nero Opaco / Matt Black

Power UP: **48W**
Input: **220/240V**
Lumen: **3400Lm**
CRI: **>80**
Light temp.: **3000°K**
IP: **20**
Pack: **0,047 m³**

FINISHING

 Bianco Opaco / Matt White

 Nero Opaco / Matt Black

PING-PONG

Luce orientabile per giocare con stile
Adjustable light for stylish play

La rotazione indipendente delle due parabole permette di realizzare chiaroscuri particolari, orientando la luce in modo giocoso su una parete piuttosto che sull'altra. Sorgente di luce dai dettagli ricercati, orientabili per un'illuminazione particolarmente ricercata.

The independent rotation of the two paraboles allows you to create particular chiaroscuro, directing the light in a playful way on one wall rather than on the other. A light source with elegant details, adjustable for a particularly refined lighting.





PING-PONG

Piantana dimmerabile ed orientabile con struttura in alluminio.
 Finitura in bianco o nero opaco.
 Diffusore in vetro satinato.
 Modulo LED e trasformatore incluso.
 Rotazione testa: 270°.

Dimmable and adjustable floor lamp with aluminium structure.
 White or black matt finish.
 Satin glass diffuser.
 LED module and transformer included.
 Head rotation: 270°.



GP1B01 Bianco Opaco / Matt White

Power: **28W**
 Input: **220/240V**
 Lumen: **2000Lm**
 CRI: **>80**
 Light temp.: **3000°K**
 IP: **20**
 Pack: **0,036 m³**



GP1N01 Nero Opaco / Matt Black

Power: **28W**
 Input: **220/240V**
 Lumen: **2000Lm**
 CRI: **>80**
 Light temp.: **3000°K**
 IP: **20**
 Pack: **0,036 m³**

FINISHING



Bianco Opaco / Matt White



Nero Opaco / Matt Black



VETRO IN LASTRA

MICHELA



**Un classico dell'interior design grazie alle sue linee
curve, semplici, pulite**

**An interior design classic with clean and simple
curves**





movies due Friday

bricot mi-wit
caramel beurre salé
chewing-Gum
proseille
lique
Muguet
Myrtille
cinnamon rouge

for drinks on

-Strune
-Pamplemousse

Dentist 10am

Eggs
for pancakes

Harriet
17th Oct
(Big 40!)

sugar
poppy seeds
popcorn
Muscadine
E.O.
Almonds

twinkle
twinkle...



MICHELA

Base in metallo, particolari cromo.
Diffusore in vetro colorato bianco.
Finitura lucida.

Metal fitting with chrome finish.
White coloured glass. Polish finish.

MICHELA A/P



Socket: **1xE27**
Power: **max 42W**
Input: **220/240V**
Pack: **0,007 m³**



MICHELA A/G



Socket: **2xE14**
Power: **max 2x28W**
Input: **220/240V**
Pack: **0,009 m³**

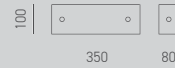

MICHELA P/P



Socket: **2xE27**
Power: **max 2x42W**
Input: **220/240V**
Pack: **0,012 m³**

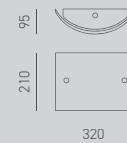

MICHELA P/M



Socket: **2xE27**
Power: **max 2x52W**
Input: **220/240V**
Pack: **0,033 m³**

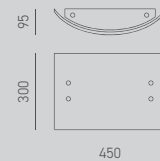

GLASSES



Bianco / White

NEREIDE



Movimento e luce si vestono di eterea bellezza
Movement and light dressed in ethereal beauty







UNICITÀ E FORME
CONVENZIONALI
SI INTRECCIANO
FORMANDO
UN'IMPECCABILE
EQUILIBRIO.

UNIQUENESS AND
CONVENTIONAL FORMS
INTERTWINE, FORMING
AN IMPECCABLE
BALANCE.



NEREIDE

Montatura in metallo, particolari cromo.
Diffusore in vetro serigrafato bianco.
Finitura satinata.

Chrome metal fitting.
Etched satined white glass.
Matt finish.



NEREIDE A

Socket: **2xE14**
Power: **max 2x28W**
Input: **220/240V**
Pack: **0,01 m³**



NEREIDE P/P

Socket: **2xE27**
Power: **max 2x42W**
Input: **220/240V**
Pack: **0,018 m³**

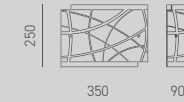

NEREIDE P/M

Socket: **2xE27**
Power: **max 2x52W**
Input: **220/240V**
Pack: **0,026 m³**

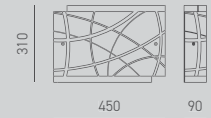

NEREIDE S/M

Socket: **2xE27**
Power: **max 2x52W**
Input: **220/240V**
Pack: **0,046 m³**

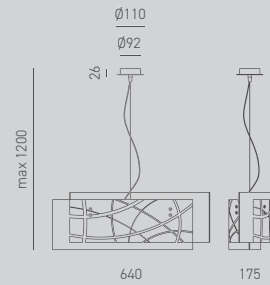

NEREIDE L

Socket: **1xE14**
Power: **max 42W**
Input: **220/240V**
Pack: **0,018 m³**

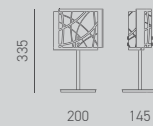

GLASSES

 Bianco / White

AGNESE

**Un gioco di contrasti per un effetto
dinamico e grafico**

**A game of contrasts gives a dynamic
and graphic effect**

Le decorazioni tribal con dettagli bianchi regalano un contrasto ottimale
con gli spazi più raffinati.

Tribal decorations with white details provide an excellent contrast
with more refined spaces.

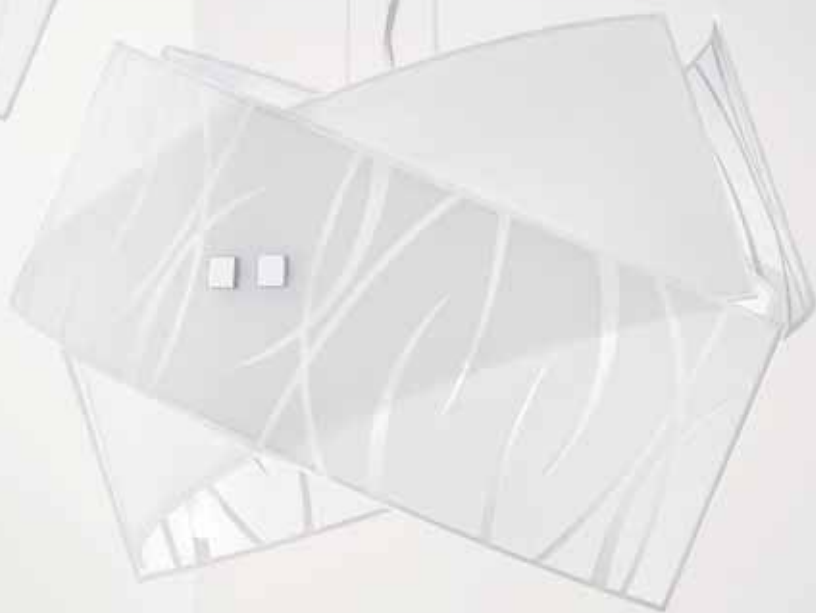
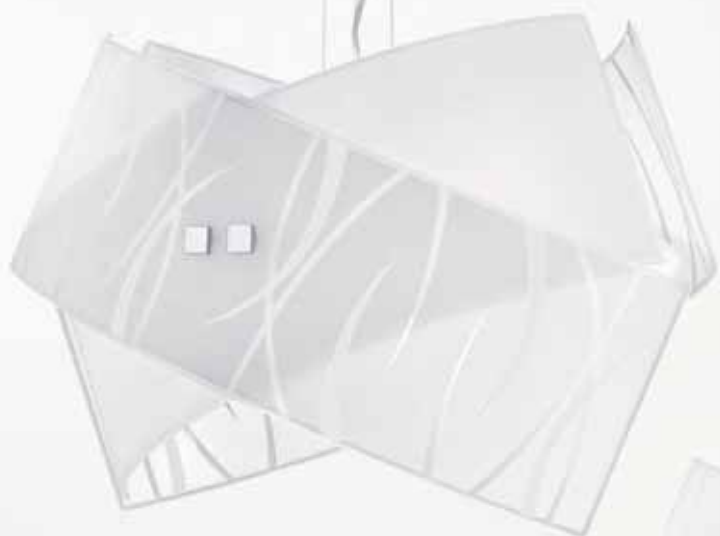









AGNESE

Montatura in metallo con finitura cromo per lumetto e sospensioni.
 Montatura in metallo bianco per applique e plafoniere. Diffusore con vetro serigrafato e decorato bianco.
 Finitura satinata.

Metal fitting with chrome finish for table and suspension lamps.
 White painted metal fitting for wall, ceiling and lamps. Diffuser with white silk screen printed and decorated glass
 Satin finish.



AGNESE A/P

Socket: **2xE14**
 Power: **max 2x28W**
 Input: **220/240V**
 Pack: **0,013 m³**



AGNESE A/M

Socket: **4xE14**
 Power: **max 4x28W**
 Input: **220/240V**
 Pack: **0,025 m³**

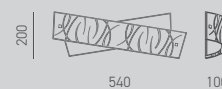

AGNESE L/P

Socket: **1xE14**
 Power: **max 42W**
 Input: **220/240V**
 Pack: **0,013 m³**

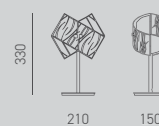

AGNESE P/P

Socket: **3xE14**
 Power: **max 3x28W**
 Input: **220/240V**
 Pack: **0,022 m³**



AGNESE P/M

Socket: **2xE27**
 Power: **max 2x70W**
 Input: **220/240V**
 Pack: **0,046 m³**

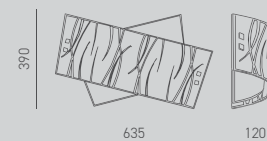

GLASSES



Bianco / White

AGNESE S/M

Socket: **2xE27**
 Power: **max 2x52W**
 Input: **220/240V**
 Pack: **0,032 m³**

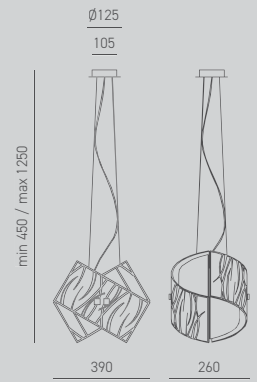
**AGNESE S/G**

Socket: **2xE27**
 Power: **max 2x70W**
 Input: **220/240V**
 Pack: **0,058 m³**

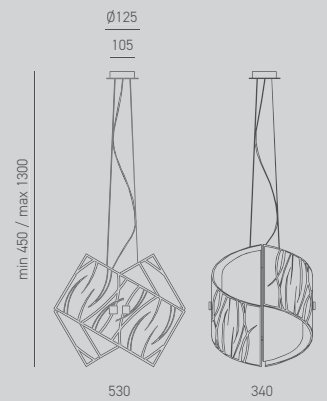

FRIDA



**Geometrica, modulare per un gioco
di trasparenze mai banali**
Geometric and modular transparencies
you'll never tire of

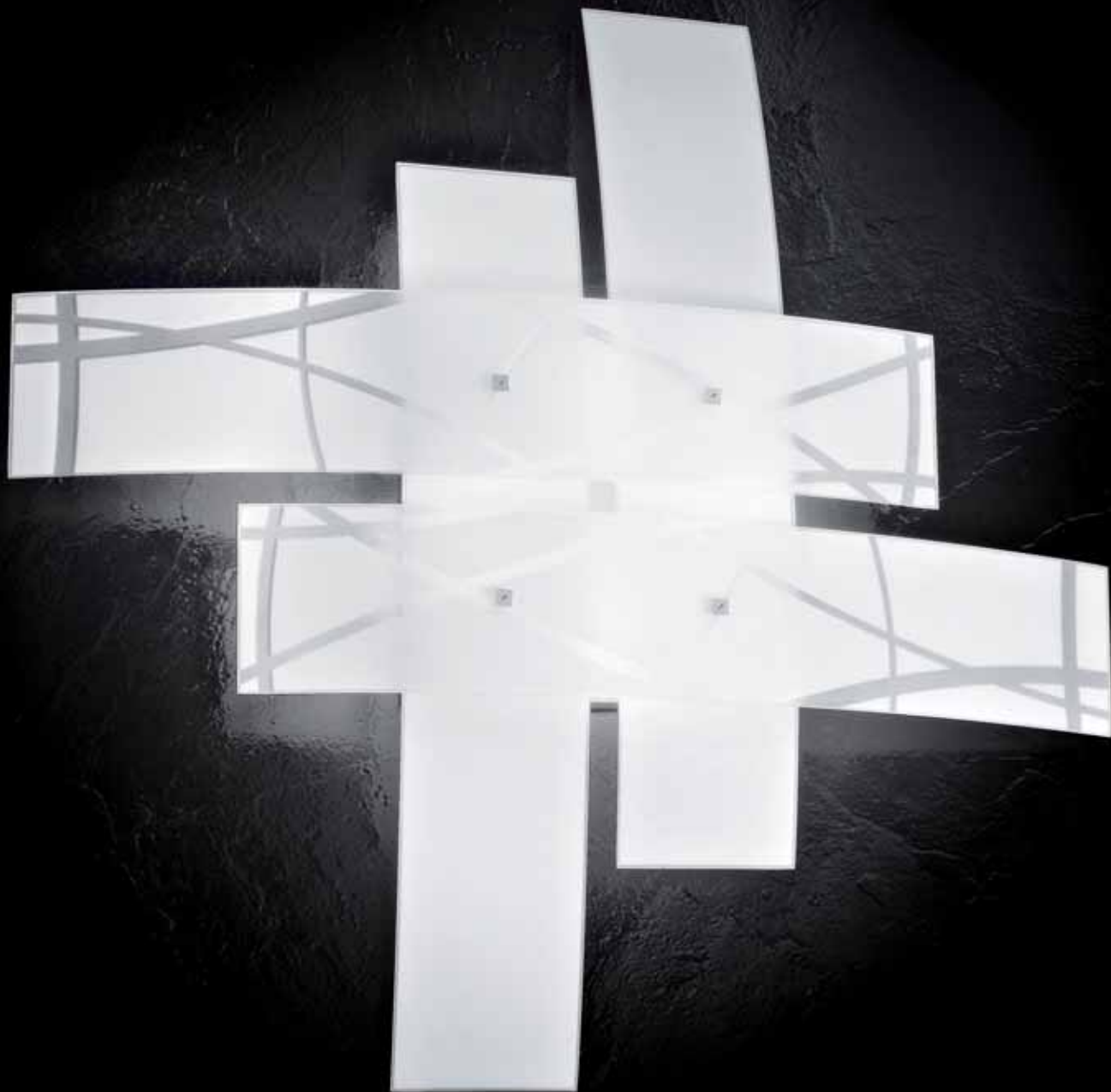



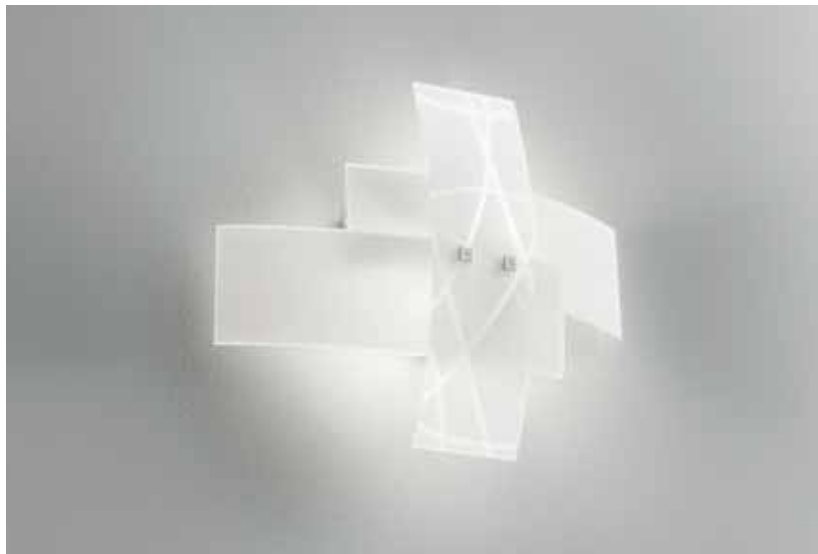
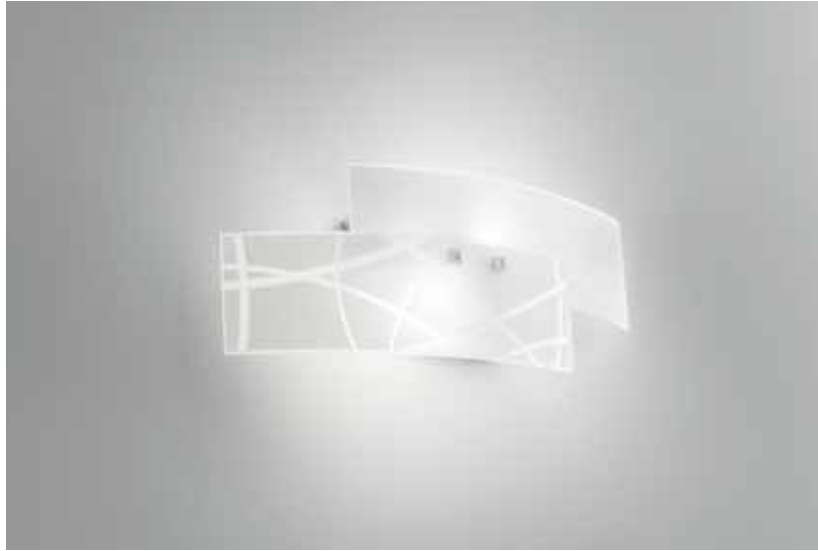



FRIDA

Montatura in metallo, finitura cromo.
Vetri satinati e colorati in bianco.
Finitura satinata.

Metal fitting with chrome finish.
Coloured and satined white glass.
Matt finish.



FRIDA A/P

Socket: **2xE14**
Power: **max 2x42W**
Input: **220/240V**
Pack: **0,013 m³**

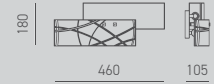

FRIDA A/G

Socket: **2xE14**
Power: **max 2x42W**
Input: **220/240V**
Pack: **0,013 m³**

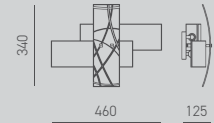

FRIDA P/P

Socket: **2xE27**
Power: **max 2x52W**
Input: **220/240V**
Pack: **0,025 m³**

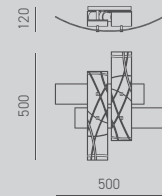

FRIDA P/M

Socket: **2xE27**
Power: **max 2x70W**
Input: **220/240V**
Pack: **0,036 m³**

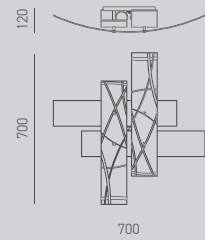

FRIDA P/G

Socket: **4xE27**
Power: **max 4x52W**
Input: **220/240V**
Pack: **0,060 m³**

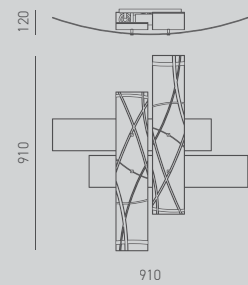

GLASSES



Bianco / White

CAMILLA



Gioielli di luce per uno stile prêt-à-porter
Gems of light with a ready-to-wear style





IN CAMILLA, LA LIBERTÀ
DI FORMATO SI SPOSA
CON LA RICERCATEZZA
DELLE FASCE
DOMINANTI, DECORATE
CON FOGLIA ORO E
ARGENTO.

THE FREE SHAPE OF
CAMILLA PERFECTLY
ACCOMPANIES REFINED
PREDOMINANT BANDS,
DECORATED WITH GOLD
AND SILVER LEAF.





CAMILLA

Montatura in metallo con finitura cromo per lumetto e sospensioni.

Montatura in metallo bianco per applique e plafoniere. Diffusore con vetri colorati foglia oro o foglia argento.

Finitura lucida.

Metal fitting with chrome finish for table and suspension lamps.

White painted metal fitting for wall and ceiling.

Diffuser with colour glass, gold or silver leaf. Gloss finish.



CAMILLA A/P

Socket: **2xE14**
Power: **max 2x28W**
Input: **220/240V**
Pack: **0,013 m³**



CAMILLA A/M

Socket: **4xE14**
Power: **max 4x28W**
Input: **220/240V**
Pack: **0,025 m³**

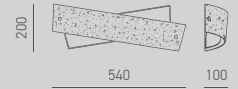

CAMILLA L/P

Socket: **1xE14**
Power: **max 42W**
Input: **220/240V**
Pack: **0,013 m³**

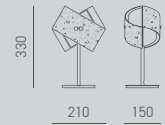

CAMILLA P/P

Socket: **3xE14**
Power: **max 3x28W**
Input: **220/240V**
Pack: **0,022 m³**

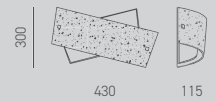

CAMILLA P/M

Socket: **2xE27**
Power: **max 2x70W**
Input: **220/240V**
Pack: **0,046 m³**

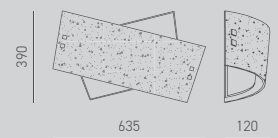

CAMILLA S/G

Socket: **2xE27**
Power: **max 2x70W**
Input: **220/240V**
Pack: **0,058 m³**

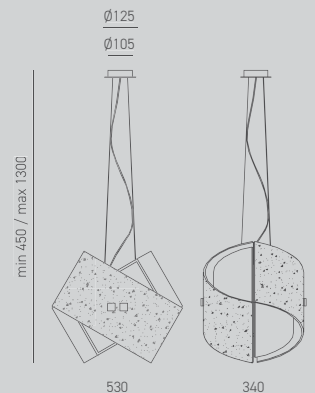

FINISHING



Foglia Oro / Gold Leaf



Foglia Argento / Silver Leaf

LARA



**Preziosa modularità per combinazioni
dal sapore modern-chic**
Stylish modularity for the modern-chic effect





UNA SOVRAPPOSIZIONE
GEOMETRICA
E CROMATICA
DALL'APPEAL MODERNO
E RICERCATO. SPAZIO
AL COLORE, AGLI
ABBINAMENTI, ALLA
PARTICOLARITÀ.

OVERLAPPING SHAPES
AND COLOURS
WITH REFINED MODERN
APPEAL. A FOCUS ON
COLOUR, COMBINATIONS
AND DETAIL.





LARA

Montatura in metallo con finitura cromo.
Diffusore in vetro bianco con particolari
foglia oro o foglia argento.

Metal fitting with chrome finish. White glass
with gold or silver leaf coloured glass.
Polish finish.



LARA A/P

Socket: **2xE14**
Power: **max 2x42W**
Input: **220/240V**
Pack: **0,012 m³**



LARA P/P

Socket: **2xE27**
Power: **max 2x52W**
Input: **220/240V**
Pack: **0,024 m³**

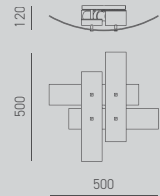

LARA P/M

Socket: **2xE27**
Power: **max 2x70W**
Input: **220/240V**
Pack: **0,035 m³**

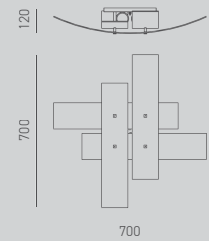

LARA P/G

Socket: **4xE27**
Power: **max 4x52W**
Input: **220/240V**
Pack: **0,06 m³**

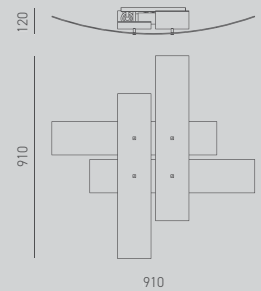

FINISHING



Foglia Oro / Gold Leaf



Foglia Argento / Silver Leaf

LECCE



**Essenzialità allo stato puro per lasciare la luce
protagonista assoluta**

Pure minimalism: the light is the star



LECCE È UNA LAMPADA PERFETTA PER OGNI SOLUZIONE D'ARREDO, SIA ESSA CLASSICA O MODERNA, È IN GRADO DI DECORARE LA CASA PONENDO UN ACCENTO DI LUCE DELICATO SULL'AMBIENTE CHE LA ACCOGLIE.

LECCE IS THE PERFECT LAMP TO FURNISH ANY STYLE OF INTERIOR, WHETHER IT IS CLASSIC OR MODERN. IT DECORATES THE HOME BY CASTING A DELICATE ACCENT OF LIGHT OVER ANY SPACE IT IS POSITIONED.



LECCE

Montatura in metallo, particolari cromo.
Vetro serigrafato bianco, finitura satinata.

Chrome metal fitting.
Etched satined white glass.



LECCE A/P

Socket: **1xE27**
Power: **max 42W**
Input: **220/240V**
Pack: **0,007 m³**



LECCE A/G

Socket: **2xE14**
Power: **max 2x28W**
Input: **220/240V**
Pack: **0,009 m³**



LECCE P/P

Socket: **2xE27**
Power: **max 2x42W**
Input: **220/240V**
Pack: **0,012 m³**

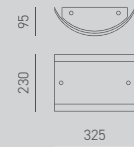

LECCE P/M

Socket: **2xE27**
Power: **max 2x52W**
Input: **220/240V**
Pack: **0,033 m³**

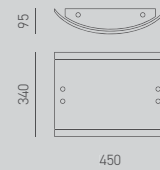

GLASSES

 Bianco / White

INDICE INFORMAZIONI TECNICHE

TECHNICAL INFORMATION INDEX

AFRODITE P/M	323	BILDE P/P	355	CRISEIDE S/P ORO	194	ERIKA S/P	184
AFRODITE P/P	323	BLANCA S/P	257	DAFNE S/3P	69	FIRENZE BI	46
AGNESE A/M	434	BONELLA S/P	253	DAFNE S/G	69	FIRENZE BI AO	46
AGNESE A/P	434	CAMILLA A/M	447	DAFNE S/P	69	FIRENZE BI AV	46
AGNESE L/P	434	CAMILLA A/P	447	DAFNE SP/I	69	FIRENZE BI GT	46
AGNESE P/M	434	CAMILLA L/P	447	DHARMA P/G	315	FIRENZE BI ST	46
AGNESE P/P	434	CAMILLA P/M	447	DHARMA P/P	315	FIRENZE BI TA	47
AGNESE S/G	435	CAMILLA P/P	447	DIVA A	221	FLOR P/G BIANCO	273
AGNESE S/M	435	CAMILLA S/G	447	DIVA L	221	FLOR P/G NERO	273
ALICE B R/3	93-107-121-137	CHRISTINE P/G	313	DIVA P/P	221	FLOR P/G ORO	273
ALICE B T/3	93-107-121-137	CHRISTINE P/P	313	DIVA S/G	220	FLOR P/M BIANCO	273
ALICE B T/6	93-107-121-137	CINZIA S	265	DIVA S/P	220	FLOR P/M NERO	273
ALICE B/1	93-107-121	CLEOFE S/3	147	DIVA S/S	220	FLOR P/M ORO	273
ALICE M S/G	127	CLEOFE S/6	147	DOHA A/G	311	FLOR P/P BIANCO	273
ALICE M S/P	127	CLEOFE S/10	146	DOHA A/P	311	FLOR P/P NERO	273
ALICE M SR/P	137	CLEOFE S/11	146	DOHA P/G	311	FLOR P/P ORO	273
ALICE V/G	127	CLEOFE S/12	146	DOHA P/M	311	FLOR P/S BIANCO	273
ALICE V/P	127-136	CRISEIDE S/2D BIANCO	195	DOHA P/P	311	FLOR P/S NERO	273
APRILIA RE/P	36	CRISEIDE S/2D ORO	195	EMILY P	241	FLOR P/S ORO	273
APRILIA RE/RP	37	CRISEIDE S/2G BIANCO	194	EMILY S	241	FORTUNA A/G BIANCO	291
BABOL A	299	CRISEIDE S/2G ORO	194	ENILA A BIANCO	287	FORTUNA A/G NERO	291
BARBIE S/G	261	CRISEIDE S/2P BIANCO	194	ENILA A ORO	287	FORTUNA A/G ORO	291
BARBIE S/P	261	CRISEIDE S/2P ORO	194	ENILA A TITANIO	287	FORTUNA A/P BIANCO	291
BILBAO P/G	359	CRISEIDE S/3D BIANCO	195	ERIKA S/2	184	FORTUNA A/P NERO	291
BILBAO P/M	359	CRISEIDE S/3D ORO	195	ERIKA S/2D	185	FORTUNA A/P ORO	291
BILBAO P/P	359	CRISEIDE S/G BIANCO	194	ERIKA S/3	184	FRIDA A/G	441
BILDE P/G	355	CRISEIDE S/G ORO	194	ERIKA S/3D	185	FRIDA A/P	441
BILDE P/M	355	CRISEIDE S/P BIANCO	194	ERIKA S/G	184	FRIDA P/G	441

FRIDA P/M	441	GAP450C	392	GAP501C	377	GPIN01	415
FRIDA P/P	441	GAP450N	392	GAP501N	377	GPIN10	411
GAETA BI	48	GAP451C	392	GAP510C	379	GSO070	157
GAETA BI AO	48	GAP451N	392	GAP510N	379	GSO071	157
GAETA BI AV	48	GAP452C	392	GAP511C	379	GSO072	157
GAETA BI GT	48	GAP452N	392	GAP511N	379	GSO073	157
GAETA BI SP/1	49	GAP453C	392	GBITR1	50	GSO074	157
GAETA BI SP/2	49	GAP453N	392	GBITR2	50	GSO075	157
GAETA BI SP/3	49	GAP460C	393	GENOVA SP	38	GSO080	157
GAETA BI SP/4	49	GAP460N	393	GISELLE P/G	363	GSO081	157
GAETA BI ST	48	GAP461C	393	GISELLE P/M	363	GSO082	157
GAETA BI TA	49	GAP461N	393	GISELLE P/P	363	GSO083	157
GAETA CO D	50	GAP462C	393	GISELLE S	363	GSO084	157
GAETA CO S	50	GAP462N	393	GLS001	403	GSO085	157
GAETA CO T	50	GAP463C	393	GLS002	403	GSO090	157
GAETA COV	47-48	GAP463N	393	GLS003	403	GSO091	157
GAETA COV 2	47-48	GAP470C	387	GLS004	403	GSO092	157
GAETA TR	50	GAP470N	387	GLS005	403	GSO093	157
GAETA TR R1	50	GAP480C	383	GLS020	401	GSO094	157
GAETA TR R2	50	GAP481C	383	GLS021	401	GSO095	157
GAP440C	391	GAP482C	383	GLS022	401	GSOB01	153-167
GAP440N	391	GAP483C	383	GLS023	401	GSOB02	153-167
GAP441C	391	GAP490C	397	GORIZIA RE/G	34	GSOB03	153-167
GAP441N	391	GAP491C	397	GORIZIA RE/M	34	GSOB04	153-167
GAP442C	391	GAP492C	397	GORIZIA RE/P	34	GSOB05	153-167
GAP442N	391	GAP493C	397	GORIZIA RE/RP	35	GSOB06	153-167
GAP443C	391	GAP500C	377	GPIB01	415	GSOB10	153-167
GAP443N	391	GAP500N	377	GPIB10	411	GSOB11	153-167

INDICE INFORMAZIONI TECNICHE

TECHNICAL INFORMATION INDEX

GSOB12	153-167	GSOBL01	93-107-121-137-153-167	GSOCW2	169	GSOS03	152
GSOB13	153-167	GSOBL02	93-107-121-137-153-167	GSOCW5	169	GSOS04	152
GSOB14	153-167	GSOBL03	93-107-121-137-153-167	GSOP01	337	GSOS05	152
GSOB15	153-167	GSOBL04	153-167	GSOP02	337	GSOS06	152
GSOB20	152-166	GSOBL05	153-167	GSOP03	337	GUYA S/1	61
GSOB21	152-166	GSOBL06	153-167	GSOP04	337	GUYA S/3	61
GSOB22	152-166	GSOBL10	93-107-121-137-153-167	GSOP05	337	GUYA S/I	61
GSOB23	152-166	GSOBL11	93-107-121-137-153-167	GSOP06	337	HELENA S/1	73
GSOB24	152-166	GSOBL12	93-107-121-137-153-167	GSOP70	166	HELENA S/3	73
GSOB25	152-166	GSOBL13	153-167	GSOP71	166	IOLE L	209
GSOB30	153-167	GSOBL14	153-167	GSOP72	166	IOLE PT	209
GSOB31	153-167	GSOBL15	153-167	GSOP73	166	IOLE S/1	208
GSOB32	153-167	GSOCB2	169	GSOP74	166	IOLE S/2	208
GSOB33	153-167	GSOCB5	169	GSOP75	166	IOLE S/3	208
GSOB34	153-167	GSOCG2	169	GSOP80	166	ISOTTA P/G	369
GSOB35	153-167	GSOCG5	169	GSOP81	166	ISOTTA P/M	369
GSOB40	152-166	GSOCM2	169	GSOP82	166	ISOTTA P/P	369
GSOB41	152-166	GSOCM5	169	GSOP83	166	ISOTTA S	369
GSOB42	152-166	GSOCN2	169	GSOP84	166	JESI SP	42
GSOB43	152-166	GSOCN5	169	GSOP85	166	JULIETTE S BIANCO	249
GSOB44	152-166	GSOCO2	169	GSOP90	166	JULIETTE S NERO	249
GSOB45	152-166	GSOCO5	169	GSOP91	166	KRIZIA P/G BIANCO 3000°K	230
GSOB50	153-167	GSOCR2	169	GSOP92	166	KRIZIA P/G BIANCO 4000°K	230
GSOB51	153-167	GSOCR5	169	GSOP93	166	KRIZIA P/G NERO	231
GSOB52	153-167	GSOCS2	169	GSOP94	166	KRIZIA P/G ORO	231
GSOB53	153-167	GSOCS5	169	GSOP95	166	KRIZIA P/M BIANCO 3000°K	230
GSOB54	153-167	GSOCV2	169	GSOS01	152	KRIZIA P/M BIANCO 4000°K	230
GSOB55	153-167	GSOCV5	169	GSOS02	152	KRIZIA P/M NERO	231

KRIZIA P/M ORO	231	LECCE P/P	457	NUMA V/P	120	TOSCA P/3 4000°K	335
KRIZIA P/P BIANCO 3000°K	230	LIVORNO S	43	OFELIA S/10	92	TOSCA P/4 3000°K	335
KRIZIA P/P BIANCO 4000°K	230	LORETO S	44	OFELIA S/11	92	TOSCA P/4 4000°K	335
KRIZIA P/P NERO	231	LUNA P/G	375	OFELIA S/12	92	TULLIA P/3 3000°K	327
KRIZIA P/P ORO	231	LUNA P/M	375	PIXEL P/G	351	TULLIA P/3 4000°K	327
KRIZIA P/S BIANCO 3000°K	230	LUNA P/P	375	PIXEL P/M	351	TULLIA P/4 3000°K	327
KRIZIA P/S BIANCO 4000°K	230	LUNA S	375	PIXEL P/P	351	TULLIA P/4 4000°K	327
KRIZIA P/S NERO	231	MELANIA P/G 3000°K	319	PLUG A	295	YARA P/G C	237
KRIZIA P/S ORO	231	MELANIA P/G 4000°K	319	RAIKA V/G	106	YARA P/G N	237
KRIZIA P/X BIANCO 3000°K	230	MELANIA P/M 3000°K	319	RAIKA V/P	106	YARA P/M C	237
KRIZIA P/X BIANCO 4000°K	230	MELANIA P/M 4000°K	319	RAKE AL	281	YARA P/M N	237
KRIZIA P/X NERO	231	MELANIA P/P 3000°K	319	RAKE AXL	281	YARA P/P C	237
KRIZIA P/X ORO	231	MELANIA P/P 4000°K	319	SFERA S	175	YARA P/P N	237
KRIZIA S/2 BIANCO	229	MICHELA A/G	421	SFERA S/6	175	YARA S/G C	237
KRIZIA S/2 ORO	229	MICHELA A/P	421	SFERA S/10	175	YARA S/G N	237
KRIZIA S/G BIANCO	229	MICHELA P/M	421	SHEILA P/G	283	YARA S/P C	237
KRIZIA S/G ORO	229	MICHELA P/P	421	SHEILA P/P	283	YARA S/P N	237
KRIZIA S/M BIANCO	229	MODENA SP/G	41	STEP A/G	347	YOANA A/G	301
KRIZIA S/M ORO	229	MODENA SP/P	40	STEP A/P	347	YOANA A/P	301
KRIZIA S/P BIANCO	229	NARDÒ S	45	STEP P/M	347		
KRIZIA S/P ORO	229	NARDÒ SP	39	STEP P/P	347		
LARA A/P	453	NEREIDE A	427	TESSA P/3 3000°K	331		
LARA P/G	453	NEREIDE L	427	TESSA P/3 4000°K	331		
LARA P/M	453	NEREIDE P/M	427	TESSA P/5 3000°K	331		
LARA P/P	453	NEREIDE P/P	427	TESSA P/5 4000°K	331		
LECCE A/G	457	NEREIDE S/M	427	TOSCA P/1 3000°K	335		
LECCE A/P	457	NICOLE L	407	TOSCA P/1 4000°K	335		
LECCE P/M	457	NUMA M SR	106-120	TOSCA P/3 3000°K	335		

CONDIZIONI GENERALI DI VENDITA

GENERAL SALES CONDITIONS

CONDIZIONI GENERALI DI VENDITA

Le descrizioni e le illustrazioni dei prodotti devono intendersi a titolo indicativo. È vietata la riproduzione, la copia anche parziale e la diffusione di questo documento attraverso qualsiasi mezzo (telematico, fotocopia o altro) senza permesso scritto del proprietario. Pertanto la GEA LUCE si riserva il diritto di fare tutte le modifiche per migliorare il prodotto senza obbligo di preavviso.

Non verranno accettati ritorni di merce se non preavvisati e da noi espressamente autorizzati. Porto Franco euro 150,00 (netti).

Saranno addebitati euro 10,00 come contributo per spese di trasporto e imballo per ordini inferiori a euro 150,00 (netti). Non verrà addebitato nessun costo aggiuntivo per il contributo RAEE sostenuto dall'azienda.

Per ogni controversia è competente il Foro di Foggia.

GENERAL SALES CONDITIONS

Strict accuracy of descriptions and illustrations of the products cannot be guaranteed. No part of this document may be reproduced or transmitted in any form, by any means (electronic, photocopying, recording or otherwise) without the prior written permission of the owner.

There fore due to its policy of product improvement, GEALUCE reserves the right to make any changes without notice. No goods may be returned without previous GEA LUCE's written permission. All goods supplied ex factory.

The RAEE costs will be hold from our company. All legal actions to take place under the jurisdiction of the Foggia Authorities.



GEA LUCE s.r.l.
Via Teodoro Tardio
71016 San Severo (FG)

T +39 0882 37.49.54
F +39 0882 33.61.61

www.gealuce.com
Amministrazione: amministrazione@gealuce.com
Commerciale Italia: info@gealuce.com
Commerciale estero: estero@gealuce.com
Assistenza tecnica: assistenza@gealuce.com



Art Direction
Mario Cappelletto

Photo / Photo editing
AsolanaGroup
Archivio Gea Luce
Quasar

Courtesy artistic work (p. 388)
Sandi Renko

Print
Asolana Group

Printed in Italy
November 2022

© GEA LUCE Srl



gealuce.com